



This is a digital copy of a book that was preserved for generations on library shelves before it was carefully scanned by Google as part of a project to make the world's books discoverable online.

It has survived long enough for the copyright to expire and the book to enter the public domain. A public domain book is one that was never subject to copyright or whose legal copyright term has expired. Whether a book is in the public domain may vary country to country. Public domain books are our gateways to the past, representing a wealth of history, culture and knowledge that's often difficult to discover.

Marks, notations and other marginalia present in the original volume will appear in this file - a reminder of this book's long journey from the publisher to a library and finally to you.

### Usage guidelines

Google is proud to partner with libraries to digitize public domain materials and make them widely accessible. Public domain books belong to the public and we are merely their custodians. Nevertheless, this work is expensive, so in order to keep providing this resource, we have taken steps to prevent abuse by commercial parties, including placing technical restrictions on automated querying.

We also ask that you:

- + *Make non-commercial use of the files* We designed Google Book Search for use by individuals, and we request that you use these files for personal, non-commercial purposes.
- + *Refrain from automated querying* Do not send automated queries of any sort to Google's system: If you are conducting research on machine translation, optical character recognition or other areas where access to a large amount of text is helpful, please contact us. We encourage the use of public domain materials for these purposes and may be able to help.
- + *Maintain attribution* The Google "watermark" you see on each file is essential for informing people about this project and helping them find additional materials through Google Book Search. Please do not remove it.
- + *Keep it legal* Whatever your use, remember that you are responsible for ensuring that what you are doing is legal. Do not assume that just because we believe a book is in the public domain for users in the United States, that the work is also in the public domain for users in other countries. Whether a book is still in copyright varies from country to country, and we can't offer guidance on whether any specific use of any specific book is allowed. Please do not assume that a book's appearance in Google Book Search means it can be used in any manner anywhere in the world. Copyright infringement liability can be quite severe.

### About Google Book Search

Google's mission is to organize the world's information and to make it universally accessible and useful. Google Book Search helps readers discover the world's books while helping authors and publishers reach new audiences. You can search through the full text of this book on the web at <http://books.google.com/>

the 1990s, the number of people in the UK who are aged 65 and over has increased from 10.5 million to 13.5 million (19.5% of the population).

There are a number of reasons for this increase. The most important is that the life expectancy of people in the UK has increased. In 1990, the average life expectancy of a male was 74.5 years and of a female 78.5 years. In 2000, the average life expectancy of a male was 77.5 years and of a female 81.5 years.

Another reason for the increase is that the number of people who are aged 65 and over has increased in all countries of the world.

The number of people in the UK who are aged 65 and over is expected to increase further in the future.

The number of people in the UK who are aged 65 and over is expected to increase from 13.5 million in 2000 to 16.5 million in 2020.

The number of people in the UK who are aged 65 and over is expected to increase from 19.5% of the population in 2000 to 22.5% of the population in 2020.

The number of people in the UK who are aged 65 and over is expected to increase from 10.5 million in 1990 to 13.5 million in 2000.

The number of people in the UK who are aged 65 and over is expected to increase from 10.5 million in 1990 to 13.5 million in 2000.

The number of people in the UK who are aged 65 and over is expected to increase from 10.5 million in 1990 to 13.5 million in 2000.

The number of people in the UK who are aged 65 and over is expected to increase from 10.5 million in 1990 to 13.5 million in 2000.

The number of people in the UK who are aged 65 and over is expected to increase from 10.5 million in 1990 to 13.5 million in 2000.

The number of people in the UK who are aged 65 and over is expected to increase from 10.5 million in 1990 to 13.5 million in 2000.

The number of people in the UK who are aged 65 and over is expected to increase from 10.5 million in 1990 to 13.5 million in 2000.

The number of people in the UK who are aged 65 and over is expected to increase from 10.5 million in 1990 to 13.5 million in 2000.

The number of people in the UK who are aged 65 and over is expected to increase from 10.5 million in 1990 to 13.5 million in 2000.

The number of people in the UK who are aged 65 and over is expected to increase from 10.5 million in 1990 to 13.5 million in 2000.

The number of people in the UK who are aged 65 and over is expected to increase from 10.5 million in 1990 to 13.5 million in 2000.

The number of people in the UK who are aged 65 and over is expected to increase from 10.5 million in 1990 to 13.5 million in 2000.

The number of people in the UK who are aged 65 and over is expected to increase from 10.5 million in 1990 to 13.5 million in 2000.

The number of people in the UK who are aged 65 and over is expected to increase from 10.5 million in 1990 to 13.5 million in 2000.

The number of people in the UK who are aged 65 and over is expected to increase from 10.5 million in 1990 to 13.5 million in 2000.

The number of people in the UK who are aged 65 and over is expected to increase from 10.5 million in 1990 to 13.5 million in 2000.

The number of people in the UK who are aged 65 and over is expected to increase from 10.5 million in 1990 to 13.5 million in 2000.

The number of people in the UK who are aged 65 and over is expected to increase from 10.5 million in 1990 to 13.5 million in 2000.

The number of people in the UK who are aged 65 and over is expected to increase from 10.5 million in 1990 to 13.5 million in 2000.

5WB2-DGX-2PSE

This One



5WB2-DGX-2PSE

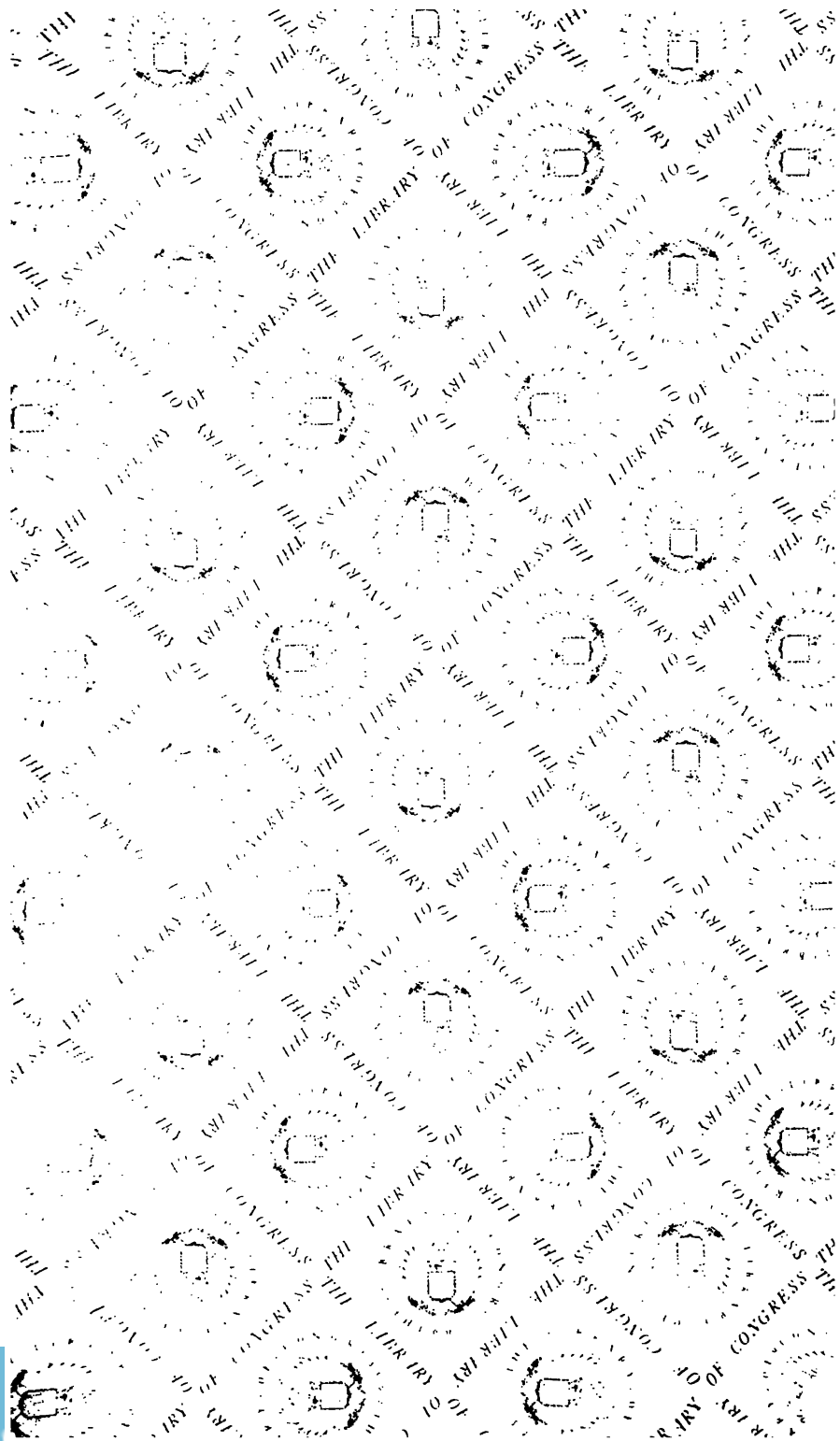

1



47-207  
All Rights Reserved.

Part  
20

THE  
JOURNAL  
OF THE  
ROYAL AGRICULTURAL SOCIETY  
OF ENGLAND.

VOLUME THE SIXTY-EIGHTH.

—  
PRACTICE WITH SCIENCE.  
—

LONDON:  
JOHN MURRAY, ALBEMARLE STREET.

1907.

ADVERTISEMENTS.

By Royal  
Appointment to



His Majesty  
the King,

**DAY & SONS, ESTABLISHED 1840.**  
**CREWE, LTD. (CREWE)**  
HORSE, CATTLE, SHEEP & DOG MEDICINES.

**DAYS' BLACK DRINK.**

THE ORIGINAL AND ONLY GENUINE. BEWARE OF NUMEROUS "BLACK" IMITATIONS.

Cures like a Colic, Colic or Colics, Shivering Fits, and Colics in Horses and Cattle; Intestinal  
Disturbances in Horses and Cattle and Sheep; Stomach Sour, and is the best general Stimulant and Tonic  
for Cattle and Lambs.  
Mostly used as a Restorative and Fecundator after Lambing and Calving; for Fatigue in Hunter  
and overworked Horses, and in all cases where nature flags.

10s. per half doz., or 19s. per doz. Bottles. Carriage paid.

**DAYS' RED DRINK**

For Fever and Disturbance in Cattle. Cleanses  
the roots of the Blood and System. For Red  
Dist. Indigestion, and Typhoid. Preserves  
the Milk for Calving. Cures Heat, Chattering and  
prevents Milk Fever.

in 12/- per doz. packets, or in Cansisters with  
water (considerable saving in price). 20/- and  
40/- Carriage paid.

The "LIVE DRINK" for Sheep, 3/6 per doz.

**DAYS' HUSKOLEIN.**

The great Anthelmintic and Tonic for  
Lambs and Cattle.

For Tapeworms and Internal Parasites in Horses  
in Lambs and other animals; for Hubs, Hoose  
Gout, or Worms in the Windpipe; Lungworm  
in Cattle, Lambs, Heifers and Sheep; Worms  
in Horses and Cattle.

6/6 per bottle; 5 bottles, 30/-; or 11 bottles, 42/-  
Carriage paid.

**DAYS' "ZOMO-SAL."**

Besting Blood Tonic for Horses and Beasts.  
Concentrated powder given in the Food for  
Anemia, Anemia, Blood Disorders, Skin  
Diseases, Disturbances, Head Lumps, General  
debility, Stomach, Off Appetite, Lack of  
energy, Indigestion, Promotes growth of bone,  
and is useful also in the prevention of Stomach  
and is given before and after foaling.

1/6 per 1/2 lb. 20/- and 40/- Carriage paid.

**DAYS' OILS.**

THE PURIFIED TRIPPLE OIL. Heal all  
Wounds in Horses, Cattle and sheep, Sore Throat  
and Sore Eyes, Ethers in Cows and Pigs. For  
Anemia and general Debility or Calving.

THE WHITE OIL for Sprains, Swellings,  
Wounds, Sprung Hooves, Rheumatism, Sore  
Throat, Weak Joints, &c.

1 Bottle, 7/6, or one large BOTTLE, 15/- Carriage paid.



**DAY & SONS'**  
**"ORIGINAL" MEDICINE CHESTS.**

Price, £2 4s., £5, and £10 10s. Carriage paid.

Sample Chest, 6s. 6d. Carriage paid.

Arranged for Horses, Cattle and Sheep (Horse only) (Lambing  
Calving, and Foaling) or in suit any class of stock. When  
ordering please state requirements.

The Chest illustrated is similar to that of £5 and £2 4s.  
Great Specifications.

ONLY ONE ADDRESS:

**DAY & SONS, CREWE, Ltd., CREWE.**

FULL PROSPECTUS (Illustrated) GRATIS AND POST FREE.



JOURNAL  
OF THE  
ROYAL AGRICULTURAL SOCIETY  
OF ENGLAND.

---

THE AGRICULTURAL HOLDINGS ACT, 1906.

**THE** Agricultural Holdings Act, which received the Royal Assent on the 21st of December, 1906, comes into operation on the 1st of January, 1909. Originally a private member's bill, known as the Land Tenure Bill, it received the friendly support of the government; the Solicitor-General assisting in its passage through the Commons—where, by amendments, its original provisions were greatly modified—and Earl Carrington piloting it through the Lords. It was in a large degree owing to the tact and reasonableness displayed by those in charge of the Bill, aided by the not unfriendly attitude adopted by the opposition in the Lower House that the measure became law. Legislation in this country is always more or less tentative in its nature; for as a people we are not given to rash experiments. An idea is popularised and is subsequently crystallised into law; if the law after a practical trial works smoothly it remains on the Statute Book, but if alterations are required, or the original idea is capable of a further advantageous development, an amending Act is passed. The new Act is intituled an Act to amend the laws relating to Agricultural Holdings. Its most important provisions are not, however, its amending provisions. It may be thought that to the new ideas embodied in law for the first time the title Land Tenure, originally applied to the Bill, would be more applicable than that of Agricultural Holdings, but the continuity of name is preserved in the latter title. Moreover, the phantom of a coming revolution in the land system ceases to alarm when launched under a name that has become familiar. Due consideration therefore can be given to the merits or demerits of the measure without any preconceived feeling of prejudice.

It is proposed to discuss (I.) those alterations in the law which may be classed as strictly amendments of the Agricultural Holdings Acts, and (II.) those sections of the Act which embody the ideas of the school of agricultural reformers responsible for its inception, and in so doing preconceived notions as to their legal effect may be put aside. Parliamentary speeches, and even the views of responsible ministers, are no aid to the lawyer in the interpretation of the Act. The Act has to be construed according to the usual canons of interpretation and these exclude approaching the matter from any outside standpoint.

## I.

It may be noticed that Sub-section 1 of Section 1 of the Agricultural Holdings Act, 1900, is repealed. It is re-enacted in the new Act, but without the proviso "that in estimating the value of any such improvement there shall not be taken into account as part of the improvement made by the tenant, what is justly due to the inherent capabilities of the soil." The section consequently now reads, "Where a tenant has made on his holding any improvement comprised in the first schedule to this Act he shall, subject as in the Agricultural Holdings (England) Act, 1883 (in this Act referred to as "The principal Act") and in this Act mentioned, be entitled at the determination of a tenancy on quitting his holding to obtain from the landlord as compensation under the said Act for the improvement such sum as fairly represents the value of the improvement to an incoming tenant." The proviso already quoted was originally omitted from the Bill of 1900 in consequence of a recommendation made by the Royal Commission on Agricultural Depression, and passed the Lower House without this proviso, but the proviso was re-inserted in that Bill in the Lords and finally became law. The view taken in the Upper House was that the omission of the proviso would induce valuers to think that by its omission it was intended that they were at liberty in assessing the value of an improvement to take into consideration the inherent capabilities of the soil. In one sense the value of an agricultural improvement is always due to the capabilities of the soil, but it is submitted that no alteration in the methods of valuation should now be made by reason of the omission of the proviso in the present Act.

## ARBITRATION.

A considerable discussion took place in the House of Lords during the progress of the measure over the sub-section of the present Act dealing with Arbitration, but the amendment of the law effected by Section 1, Sub-section 2, amounts to no

more than a simplification of procedure and the substitution of one arbitrator for two arbitrators and an umpire in all cases. Nothing will interfere with the employment of valuers by the parties as heretofore. Even now, where a tenancy agreement provides for two arbitrators, an umpire can only be appointed either by agreement between the parties or by the Board of Agriculture and Fisheries. Under the new Act, notwithstanding any agreement, only a single arbitrator can be appointed.

The sub-section, moreover, requires that future arbitrations shall not only be before a single arbitrator, but that they should be conducted "in accordance with the provisions set out in Part I. of the second schedule to the Agricultural Holdings Act, 1900." The result of thus substituting these statutory provisions for the obscure and sometimes unworkable clauses to be found in contracts of tenancy will be to get rid of a common source of difficulty and delay, and even of expensive litigation, which has, in recent practice, hindered the smooth working of these Acts. There is also a further advantage in securing the use of the form of award prescribed by the Board.

Another useful little amendment of the law provides that the arbitrator shall on the application of either party specify the amount awarded in respect of any particular improvement or any particular matter the subject of the award. The necessity for the introduction of the words "particular matter" in the present Act was occasioned by the refusal of some arbitrators to state more in their award than they were compelled to do by the actual words of the Act; as, however, under the present Act the arbitrator will be required to determine other things besides the compensation for improvements, as indeed he was, although not to the same extent, under the earlier Acts, the provision should prove useful.

#### REPAIRS TO BUILDINGS.

Those who are familiar with the text of the Agricultural Holdings Act, 1900, are aware that the first schedule to the Act is sub-divided into three parts. The first part contains a list of certain improvements for which the tenant is at liberty to claim compensation, if made with the consent of the landlord; the second, improvements in respect of which a notice to the landlord is required to be given before the work is undertaken by the tenant; and the third a list of improvements which the tenant is entitled to make without either previously giving notice to or obtaining the consent of the landlord. In this third part are now placed "repairs to buildings, being buildings necessary for the proper cultivation or working of the holding, other than repairs which the tenant is himself

under an obligation to execute." But the proviso in Section 6 of the Act provides that the tenant, before beginning to execute any such repairs, shall give to the landlord notice in writing of his intention, together with particulars of such repairs, and shall not execute the repairs unless the landlord fails to execute them within a reasonable time after receiving such notice, that is if they constitute an improvement requiring notice to be given. In all cases, in future, where repairs are required to buildings necessary for the proper cultivation or working of the holding, the landlord is entitled to receive notice from the tenant who proposes to execute the repairs, if the tenant desires to claim compensation for them. The landlord then has his option of either executing the repairs himself or allowing his tenant to do so. In the latter case the tenant will be entitled to receive compensation for the improvement on leaving his holding.

The expression "reasonable time" is used in the section. The reasonable time allowed to the landlord must be construed with reference to the circumstances of each particular case; undoubtedly time must be allowed a landlord's surveyor or agent, to examine into and report upon the proposed repairs and their cost, and some delay, in consequence, must ensue. Meanwhile, pending the landlord's decision, the tenant's hands will be tied, for neither will he undertake nor will his advisers care to recommend his undertaking repairs till the landlord has definitely declined to execute them. It would appear, therefore, that the substitution of a definite time for the expression "reasonable time," in which the election should be made, would have been more satisfactory from the tenant's point of view, as likely to lead to less trouble and delay. Further, it must be remembered that in agricultural leases provision is often made for the repair of existing buildings, such as barns, &c., by the tenant, and to such leases the section has no application, for the tenant would be bound to make such repairs by the terms of his lease.

#### RECORD OF HOLDING.

A provision which, if generally taken advantage of, will lessen disputes in future is found in Section 7 of the Act. At the termination of a tenancy, and sometimes earlier, disputes begin as to the condition of the buildings, fences, gates, roads, drains, ditches, and the state of cultivation of the holding at the commencement of the tenancy. Unless a record has been made at the time the matter has to be decided by the evidence of witnesses who speak from memory. The present provision, which enables either party to insist upon a record of the holding being taken within three months after the commencement of the tenancy, is of distinct value. The

procedure to be adopted where a record is desired, is as follows :—If the parties are unable to agree upon the person to make it, the Board of Agriculture and Fisheries will nominate a person, and the cost of the record, in default of agreement on the subject, must be borne by the landlord and tenant in equal proportions. Having regard to the new provisions in the Act with reference to freedom of cropping, disposal of produce, and unreasonable disturbance, landlords will probably insist on a record of the holding being made. In any event it is a proper precaution to adopt.

#### **AMENDMENT OF MARKET GARDENERS COMPENSATION ACT.**

The Market Gardeners Compensation Act, 1895, which is intitled "An Act to Amend the Provisions of the Agricultural Holdings (England) Act, 1883, so far as they extend to Market Gardens," has, as regards England, been amended by the Agricultural Holdings Act 1900; and the Market Gardeners Compensation (Scotland) Act, 1897, has also been amended by the same Act, which applies with certain modifications to Scotland. The new Act further amends the law both in England and Scotland. The effect of the amendment is to enable market gardeners to claim compensation for those improvements for which there is a right to compensation under existing Acts, where such improvements have been effected prior to 1896 in England and 1898 in Scotland. Thus, if a market gardener had erected buildings or enlarged them for the purpose of his trade or business as a market gardener prior to the coming into force of these Acts, he could make no claim for compensation on leaving his market garden. He can under the present Act. A large proportion of market gardens have been in existence for many years. The matter is therefore of some importance. By making buildings erected before the coming into force of the Market Gardeners Compensation Act subjects of compensation, it is further submitted that (inasmuch as a market garden is a holding to which the Agricultural Holdings Act of 1900 applies), market gardeners will be able to claim for the repair of these buildings as an improvement, subject to following the procedure already described; they will therefore be able to claim compensation, both in respect of the buildings and the repairs, but the repairs only where they are under no legal liability to repair. This amendment of the law in favour of market gardeners may tend to give improved advantage to those engaged in this trade.

#### **FREEDOM OF CROPPING.**

§ The doctrine of the inviolability of a contract has received so many blows of late years that it would not be surprising to

find that that school of thought which denies the existence of a free contract unless the parties meet on absolutely independent terms, claimed that they alone had influenced the passing of Section 3 of the new Act. The origin of the section is, however, more likely to be found in the desire of the tenant farmer to carry out his business untrammelled by unnecessary restrictions. He can urge, and has urged hitherto, that since he embarks his capital in farming the proper rotation of the crops is essentially a matter for him so long as the landlord's land is not deteriorated in the process.

The landlord, hitherto, has considered it necessary in many instances to provide for the due rotation of crops on arable land—and he has secured this by insisting on the tenant cultivating either according to the covenants of his lease or the custom of the country. He has argued that past experience has shown the capabilities of the land, and that any departure from precedent in the methods of cultivation would be likely to prove detrimental to his interest. If Section 3 is examined it will be found enacted that “notwithstanding any custom “of the country or the provisions of any contract of tenancy “or agreement respecting the method of cropping of arable “lands, or the disposal of crops, a tenant shall have full right “to practise any system of cropping of the arable land on his “holding and to dispose of the produce of his holding without “incurring any penalty, forfeiture, or liability.” Before dealing with the provisions by which this right is secured it must be noticed that its apparent effect is to render all provisions in contracts of tenancy or agreements void in so far as they prescribe a specific method of cropping, but in effect this means only conditionally void, for when the provisos are examined it will be found that the right of free cropping and disposal of produce depends upon the fact of the tenant having previously made, or so soon thereafter as may be made, suitable and adequate provision to protect the holding from injury. If this is not done the penalties, forfeitures, and liabilities will still be enforceable. It must also be noticed that there is no freedom of cropping and disposal of produce in the case of yearly tenancies as respects the year before a tenant quits his holding, nor during any period after he has given or received a notice to quit which results in his quitting the holding, nor in any other case as respects the year before the expiration of the contract of tenancy. The effect of the section seems to be that neither a penalty, forfeiture, nor any liability can be incurred except where the tenant has failed to make suitable and adequate provision to protect the holding from injury or deterioration, or during these specified periods. The suitable and adequate provision to protect the holding from injury is

defined as consisting "in the case of the disposal of the produce of the holding, in the return to the holding of the full equivalent manorial value to the holding of all crops sold off or removed from the holding in contravention of the custom, contract, or agreement."

Whilst apparently the landlord could, under the existing law, have always proceeded for a penalty or forfeiture where the holding was injured in contravention of the terms of the lease, a power in express terms is now conferred upon him by Sub-section 2 of Section 3. This sub-section provides that if the tenant exercises his rights, that is, if he chooses his own method of cropping or disposes of the produce as he pleases, and in doing so injures or deteriorates the holding, or is likely to injure or deteriorate it, the landlord, without prejudice to any other remedy which may be open to him, can proceed to recover damages "in respect of such injury or deterioration at any time, and should the case so require, he can obtain an injunction, or in Scotland an interdict restraining the exercise of the tenant of his new rights under this section in that manner, and the amount of such damages may, in default of agreement, be determined by arbitration." It will of course be a matter for the landlord's consideration whether the cost of procedure by injunctions would or would not be justified in the circumstances of each case; and in estimating this, regard must be had as to whether the action could be commenced in the County Court or not.

It is possible that hereafter Section 3 will occasion considerable trouble; for the landlord's legal power to interfere is not confined to cases where actual damage is done, but extends to cases where the tenant's methods are likely to occasion injury or deterioration to the holding, that is, to anticipated mischief. Let it be assumed, for instance, that a tenant is pursuing his own methods of cropping, methods which are neither in accordance with the terms of his tenancy agreement or the custom of the country. A landlord might honestly and with perfect justice urge that the holding was being injured or deteriorated. The tenant might reply: I have already made suitable and adequate provision to protect the holding. The landlord might answer: I am not satisfied; and there directly would be created an issue of fact. But what meaning is to be attached to the words "likely to." On one construction these words might be said to seriously interfere with the freedom of cropping and disposal of produce conferred upon the tenant. In any event they render the section difficult to understand. To prevent doubt as to whether the provision that the tenant makes to protect the holding from injury or deterioration required by this section is an improvement under Part

III. of the first schedule to the Agricultural Holdings Act 1900, it is expressly enacted, that such provision shall not entitle him to compensation. Questions are certain to arise on this sub-section, but as matters of fact will concern the valuer or the arbitrator rather than the lawyer. The meaning attached to arable land is made clear by Sub-section 4 of Section 3, which declares that it shall not include land in grass which by the terms of any contract of tenancy is to be retained in the same condition throughout the tenancy. Where the retention of land in grass throughout the tenancy is desired, it would seem advisable to insert a clause in the lease or agreement insisting on such retention, otherwise land in grass will be deemed arable land.

## II.

So far those matters which may be called strictly amendments of the Agricultural Holdings Acts have been dealt with. Those other provisions of the new Statute which have been the subject of the keenest controversy now require consideration.

### COMPENSATION FOR UNREASONABLE DISTURBANCE.

The first of these is that which provides compensation for a tenant if he is unreasonably disturbed in his holding by his landlord. This is contained in Section 4 of the Act, which runs as follows :—“Where the landlord without good and sufficient cause and for reasons inconsistent with good estate management terminates a tenancy by notice to quit, or after having been requested in writing at least one year before the expiration of a tenancy to grant a renewal thereof refuses to do so, or where it has been proved that an increase of rent has been demanded from the tenant and that such increase was demanded by reason of an increase in the value of the holding due to improvements which have been executed by or at the cost of the tenant and for which he has not either directly or indirectly received an equivalent from the landlord and such demand results in the tenant quitting the holding, the tenant upon quitting the holding shall in addition to the compensation (if any) to which he may be entitled in respect of improvements and notwithstanding any agreement to the contrary be entitled to compensation for the loss or expense directly attributable to his quitting the holding which the tenant may unavoidably incur upon or in connection with the sale or removal of his household goods or his implements of husbandry produce or farm stock on or used in connection with the holding.

“Provided that no compensation under this section shall be payable—



“(a) Unless the tenant has given to the landlord a reasonable opportunity of making a valuation of such goods implements produce and stock as aforesaid ; or

“(b) Unless the tenant has within two months after he has received notice to quit or a refusal to grant a renewal of the tenancy as the case may be given to the landlord notice in writing of his intention to claim compensation under this section ; or

“(c) Where the tenant with whom a contract of tenancy was made has died within three months before the date of the notice to quit or in the case of a lease for years before the refusal to grant a renewal ; or

“(d) If the claim for compensation is not made within three months after the time at which the tenant quits the holding.

“In the event of any difference arising as to any matter under this section the difference shall in default of agreement be settled by arbitration.”

The section is here set out *in extenso*, and it is obvious that it contains a material enlargement of the existing law with reference to tenant right. Hitherto, the legislature in Agricultural Holdings Acts has proceeded on the lines of compensating a tenant for such improvements as have been made by him, but has conferred no security from disturbance other than such as he might have had the forethought to obtain for himself by the terms of his lease. One small amendment only in the law of landlord and tenant has been made by Section 33 of the Agricultural Holdings Act of 1883, namely, the substitution of a year's notice in the case of agricultural tenancies for the six months' notice, which is implied in every yearly tenancy, but it has been possible even to contract out of this provision, and there are undoubtedly agricultural tenancies existing at the present time where the tenant is liable to be evicted on a six months' notice. No attempt is made in the present Act to restrict the right of contracting out, nor is a landlord forbidden to determine a tenancy. It says, however, to him in some cases—If you exercise your undoubted right you must compensate the tenant. In other words, the notice to quit is clogged with a condition intended to prevent unfair or capricious eviction. Whether any eviction can be termed unfair or capricious in view of the fact that it can only be given in accordance with the terms of the tenancy agreed upon by the parties prior to the commencement of the tenancy, may be a matter of opinion. The new law, however, assumes that such a position exists and provides for the compensation of the tenant in the following instances : (1) where the notice to quit has been given by the landlord without good and sufficient

cause, and for reasons inconsistent with good estate management. (2) Where the landlord has been requested in writing at least one year before the expiration of a tenancy, to grant a renewal thereof and refuses to do so. (3) Where it has been proved that an increase of rent is demanded from the tenant and that such increase was demanded by reason of an increase in the value of the holding due to improvements which have been executed by, or at the cost of, the tenant and for which he has not, either directly or indirectly, received an equivalent from the landlord, and such demand results in the tenant quitting the holding.

Since the tenant's right to compensation depends upon his ability to bring himself within one of the three classes of cases, it is obvious that here is a fertile field for controversy and debate. The first point upon which information will be sought is what burden of proof is cast upon the landlord. Does the mere fact that he has given a tenant notice to quit raise a presumption that it was without good and sufficient cause, and for reasons inconsistent with good estate management, or is the burden of proof cast upon the tenant? In other words, must a tenant make out an affirmative case, or must a landlord? Supposing for instance that a landlord gives his tenant notice to quit and states in a letter accompanying the notice that he has given the notice because he desires to increase the size of an adjoining holding, and he is of opinion that the best way to do this is to reduce the size of the farm. Would this be good estate management? Could the tenant say that this was a reason inconsistent with good estate management, for good estate management would not contemplate any such alteration? Again, must good and sufficient cause be regarded from the landlord's or the tenant's point of view? If the former view is to be taken, do the words mean anything in addition "to the reasons inconsistent with good estate management" to which they are joined by the conjunction, "and"? No one could doubt that the landlord would maintain his opinion strenuously, and I suppose few would deny that the tenant would repudiate it with equal vigour. The tenant would say, If I admit that you have given me a plausible reason for serving the notice to quit, that is not good and sufficient cause to me. Why should I suffer because you contemplate making for yourself a beneficial alteration in your holdings? It may well be left to the perplexed arbitrator to resolve the meaning of these indefinite terms in his own way, unaided and untrammelled by any judicial guidance.

The second of the three alternative grounds does not give rise to the considerable difficulties that the indefinite terms employed in the first alternative do, for subject to the

provisos, which will subsequently be referred to, it would seem that a request in writing by the tenant to the landlord a year before the expiration of the tenancy asking him to renew the tenancy followed by a refusal would be sufficient to ensure compensation for disturbance. It may be pointed out here that "tenant" under Section 61 of the Agricultural Holdings Act, 1883, means the holder of land under a landlord for a term of years, or for lives and years, or from year to year. The term also includes the executors, administrators, assigns, legatees, devisees, or the next of kin, husband, guardian, committee of the estate, or trustees in bankruptcy of a tenant, or any person deriving title from a tenant, and the right to receive compensation in respect of any improvement enures to the benefit of such executors, administrators, and assigns and other persons as aforesaid.

To turn to the third alternative, this provides for the case where there has been a demand from the landlord for an increase of rent in consequence of which the tenant leaves the holding. It must be proved that this demand for increase was occasioned by an increase in the value of the holding due to improvements which have been executed by or at the cost of the tenant, and these improvements must be improvements for which he has not either directly or indirectly received an equivalent from the landlord. This alternative provides much controversial matter. The term "improvements" is not confined to the improvements comprised in the first schedule to the Agricultural Holdings Act of 1900, but would mean all improvements. In respect of improvements, for instance, outside the first schedule it might be possible for an arbitrator to ascertain whether or not the tenant had obtained an equivalent from the landlord, but would a tenant receive an equivalent by obtaining the compensation already provided for him in respect of improvements under the first schedule to the Act of 1900? An equivalent is something of equal value, and what the landlord pays or is liable for as compensation to the outgoing tenant is such sum as fairly represents the value of the improvements to the incoming tenant. The value of an improvement may be gauged as between outgoing and incoming tenant on the basis of what the latter ought to pay, but is it necessarily the test to be applied by the section?

Again, the demand for an increase of rent must be due to improvements on the holding, for which neither directly or indirectly the tenant has received an equivalent from the landlord it may be a task of some nicety for the arbitrator to determine this. The landlord is clearly entitled to the unearned increment, rising for instance from the building of a branch railway line, which provides an easier and cheaper method of

conveying the tenant's produce to markets which hitherto not been reasonably accessible, or from the building of new roads. Any increase in rent demanded from such causes must be rigorously excluded by the arbitrator for his consideration. In ordinary cases, perhaps, the task will not be one of great difficulty, but cases may occur where the causes and improvements, for which the tenant has neither directly, or indirectly, received an equivalent, are contributory to the demand for an increased rental. Such cases will require careful examination.

The amount of compensation that is provided for disturbance is the loss or expense suffered or incurred by the tenant directly attributable to his quitting the holding, and it must be unavoidably incurred upon or in connection with the removal or removal of his household goods, or his implements of husbandry, produce, or farm stock on, or used in connection with the holding.

The words "unavoidably incurred," would seem to put upon the tenant the duty of minimising any loss in this connection. He must not attempt to swell the damage by unnecessary expense, for unquestionably it is intended that the landlord should not be burdened with an exaggerated burden; indeed, whilst on the one hand, he is unable to contract himself out of his liability, for the section provides that the compensation must be awarded "notwithstanding any agreement to the contrary," the tenant, on the other hand, must, as a condition precedent to a successful claim, have afforded the landlord a reasonable opportunity of making a valuation of his household goods, implements of husbandry, produce, or farm stock on, or used in connection with, the holding, otherwise he will forfeit all right to compensation. In addition the tenant is required within three months after he has received notice to quit or there has been a refusal to grant a renewal of the tenancy, as the case may be, to give the landlord notice in writing of his intention to claim compensation.

Assuming that the notice has been given by the tenant and that he has afforded the landlord a reasonable opportunity of making the valuation described, it is still incumbent upon him to make the claim for compensation within three months after the time he quits the holding, otherwise his right to claim will be barred.

The right, moreover, of the tenant's representatives to claim compensation is barred where the tenant has died within three months before the date of the notice to quit, or in the case of a lease for years before the refusal to grant a renewal. It would seem that the "tenant" who is here meant is the original tenant, for the words employed are "the tenant with whom a contract

tenancy is made," and the use of these words apparently includes an assignee or other tenant within the meaning of the definition given of tenant under Section 61 of the Agricultural Holdings Act, 1883. If this construction is correct, great difficulty will arise in giving an equitable construction to the section, for the draughtsman of the Act surely never contemplated putting the assignee, who is a tenant within the meaning assigned to a tenant under the Act of 1883 (which is to be read and may be cited with this Act) in a better position than the tenant with whom the contract of tenancy was made. There is nothing to exclude an assignee's representatives from the benefits conferred by Section 4; he is a tenant, but Sub-section (c) has no application to him. It would seem as if Section 61 of the Agricultural Holdings Act, 1883, had been forgotten or ignored. If the words, "with whom a contract of tenancy had been made," had been omitted the whole of the section would have been far clearer.

The tribunal assigned for interpreting the difficult matters involved in this section is that of the arbitrator, and no doubt many of these will come before County Court Judges on questions of law under Section 2 (6) of the Agricultural Holdings Act, 1900.

#### COMPENSATION FOR DAMAGE BY GAME.

The respective rights of landlord and tenant to the game on the tenant's land are determined by the Game Act of 1831. This provides, by Section 7, that in all cases where a person occupies any land under a lease or agreement, made previously to the passing of the Act, the lessor or landlord shall have the right of entering upon such land or of authorising any other person who shall have obtained an annual game certificate to enter upon such land for the purpose of killing or taking the game thereon; and no person occupying any land under any lease or agreement, either for life or for years, made previously to the passing of this Act, shall have the right to kill or take the game on such land, except where the right of killing the game upon such land has been expressly granted or allowed to such person by such lease or agreement, or except where upon the original granting or renewal of such lease or agreement, a fine or fines shall have been taken or except where in the case of a term for years, such lease or agreement shall have been made for a term exceeding twenty-one years. Section 8, however, declares that nothing in the Act is to affect any existing or future agreements respecting game, nor any rights of manor, forest, chase or warren. Subsequent to the passing of this Act, the right of sporting unless expressly reserved under seal to the landlord belonged to the tenant.

This being the existing state of affairs, complaints have arisen in cases where the tenant did not possess shooting rights, of the overstocking of game, resulting in damage to the tenant's crops. The preservation of hares and rabbits led to the passing of the Ground Game Act of 1880, which conferred a concurrent right on the tenant, in his case inseparable from his occupation, to shoot them. The preamble of this Act states that its objects were the interest of good husbandry, and better to secure capital and labour invested in the cultivation of the soil, and to enable occupiers to protect their crops from injury and loss by ground game. With the omission of a few words, these objects might be stated as reasons for the passing of Section 2 of the Agricultural Holdings Act, 1906. It will be seen, however, that this section does not confer upon the occupier of the land a concurrent right to shoot the particular class of game expressly referred to in the section, as in the case of ground game under the Ground Game Act, but entitles him to claim compensation from his landlord for the damage that he has sustained. The game expressly referred to are deer, pheasants, partridges, grouse, and black game. The specific mention of these would exclude any bird that does not fall within this category. Sub-section 1 of Section 2 of the Act provides that "where the tenant has sustained damage to his crops from game, the right to kill and take which is vested neither in him nor in any one claiming under him other than the landlord, and which the tenant has not permission in writing to kill, he shall be entitled to compensation for such damage if it exceeds in amount the sum of one shilling per acre of the area over which the damage extends, and any agreement to the contrary or in limitation of such compensation shall be void."

It will be seen that the section contemplates the case where the landlord has expressly reserved the sporting rights, which otherwise, in the absence of such reservation, would belong to the tenant. It also contemplates that the tenant, who is entitled to compensation, shall have no shooting rights, for if he is empowered to kill the game he has the remedy in his own hands of protecting his crops. Therefore, if he has permission in writing to kill the game, he cannot claim compensation under this section. Moreover, the same reasoning applies to any one claiming under him other than the landlord, for if, having the right to kill, he chooses to divest himself of such right, he obviously is not entitled to relief.

During the progress of the Bill through the House of Lords it was suggested that the tenant's remedy should not be against the landlord when the landlord had let the sporting rights which he possessed, but that he should be left to bring his action against the lessees. Such lessees, however, often consist

of small syndicates or partnerships, and the difficulty of making them liable would, in practice, be considerable. Moreover, they are liable at present when they overstock the land with game, accordingly, the proposed amendment was not pursued.

The liability of persons who are entitled to shooting rights to tenants whose crops are damaged by reason of the overstocking of game, was declared in a case of *Farrer v. Nelson*, reported in the Law Reports, 15 Queen's Bench Division, page 260, as follows: "As I understand the law," said Baron Pollock, "each person in this country is entitled to bring on his land any quantity of game which can reasonably and properly be kept on it and so that nothing extraordinary and non-natural is done." The case of *Birkbeck v. Paget* (31 Beavan, page 403) which was cited by counsel for the defendants, to show that there is a difference between introducing fresh game and shifting game from one part of the land to another, is at any rate an authority that the lessee is not warranted in introducing into the land game not bred in the ordinary way. So here, so long as the lessee of the right of shooting was exercising the ordinary rights which the landlord who had reserved the right might have exercised, he was acting within his rights, but the moment he brings on game to an unreasonable amount, or causes it to increase to an unreasonable extent, he is doing that which is unlawful, and an action may be maintained by his neighbour for the damage which he has sustained.

The limitations that define the amount of compensation are as follows: "The amount of compensation payable under the section shall, in default of agreement made after the damage has been suffered, be determined by arbitration, but no compensation shall be recoverable under this section unless notice in writing is given to the landlord as soon as may be after the damage was first observed by the tenant, and a reasonable opportunity was given to the landlord to inspect the damage." This, in the case of damage to a growing crop, must be before the crop is begun to be reaped, raised, or consumed, and in the case of damage to a crop reaped or raised, before it is begun to be removed from the land. Further, notice in writing of the claim, together with particulars, must be given to the landlord within one month after the expiration of the calendar year, or such other period of twelve months as by agreement between the landlord and tenant may be substituted therefor, in respect of which the claim is made. It will be seen, therefore, that two notices in writing must be given by the tenant claiming compensation; (1) The notice of damage which affords the landlord an opportunity of inspecting the crops; (2) The notice in writing of the claim.

Let it be assumed that a claim has been made and matter has been referred to the arbitrator to assess the amount to be paid, then by Sub-section 3, Section 2 of the Act, if landlord is able to prove that under a contract of tenancy made before the commencement of the Act, compensation for damage by game was payable by him, or that in fixing rent to be paid under such contract, allowance in respect of such damage to an agreed amount was expressly made, the arbitrator must make such deduction from the compensation which would otherwise be payable under this section, as may appear just.

It would appear from a consideration of these provisions that in contracts of tenancy made after the commencement of the Act, any provisions for a fixed amount of compensation, or compensation by way of reduced rent would be void, since such provisions might be said to limit the tenant's right to compensation.

The landlord, where the right to kill and take the game is not vested in him, but in some other person, will be entitled to be indemnified by such other person against all claims for compensation under this section. These cases can only arise in those in which the tenant has exercised his rights against the landlord, no right, for instance, can exist where the tenant has disposed of the sporting rights.

In concluding my examination of this Act, I can only reiterate my belief that notwithstanding inexactitudes of expression, probably arising from its genesis as a private member's bill, and the looseness of draughtsmanship, the Act deserves to meet with success. The criticism that has been directed has been made from the point of view of those who may be called upon to explain or interpret it; this has nothing to do with the equitable or inequitable view that may be taken of its provisions. Time alone will show whether the Act allays the fears of its opponents, or disappoints the hopes of its friends.

ARTHUR P. POLEY

Temple, E.C.





## WILD BIRDS, USEFUL AND INJURIOUS.

SOME years ago the late Earl Cathcart, in the Journal of this Society,<sup>1</sup> directed the attention of agriculturists to the absence of exact information respecting the habits of the various Wild Birds useful or injurious to farmers, and urged the study of economic ornithology, as to which a serious void in English agricultural education had been found to exist. This article was followed by two communications which I prepared for the Society in 1892 and 1894.<sup>2</sup> The present paper is written to complete the series.<sup>3</sup>

A brief reference to the former papers may not be out of place. Since they were written many notes on the food of birds have been published, and it is a relief to me, as the writer of the two articles alluded to, to find that, so far as I am able to judge, this further information and my own subsequent observations do not necessitate any material alteration in the views already expressed. The Wild Birds Protection Act has been improved at intervals by amendments, enabling County Councils to protect eggs as well as the birds themselves, and to prohibit the taking and killing of particular birds throughout the year; any bird or egg taken in defiance of the Act may be forfeited, and at last, in 1904, it was enacted that "Every person who, on any pole, tree, or cairn of stones or earth, shall affix, place, or set any spring, trap, gin, or other similar instrument calculated to cause bodily injury to any wild bird coming in contact therewith, and every person who shall knowingly permit or suffer or cause any such trap to be so affixed, placed or set, shall be guilty of an offence, and shall be liable on summary conviction to a penalty not exceeding forty shillings, and for a second or subsequent offence to a penalty not exceeding five pounds." The pole-trap therefore is, happily, a thing of the past: perhaps it should rather be said that the use

<sup>1</sup> Journal, R.A.S.E., 1892, page 325.

<sup>2</sup> *Ibid.*, 1892, page 658, and 1894, page 60.

<sup>3</sup> The following is a list of the birds mentioned in the previous papers:—

**PART I.**, 1892.—Kestrel, Sparrowhawk, Peregrine, Buzzard, Merlin, Barn Owl, Tawny Owl, Long-eared Owl, Short-eared Owl, Blackbird, Thrush, Missel Thrush, Fieldfare, Redwing, Flycatcher, Robin, Hedge-sparrow, Wheatear, Whinchat, and Stonechat. **PART II.**, 1894.—Whitethroat, Lesser Whitethroat, Blackcap, Garden Warbler, Wood Wren, Willow Wren, Chiffchaff, Wren, Blue Tit, Great Tit, Coal Tit, Marsh Tit, Long-tailed Tit, Pied Wagtail, White Wagtail, Yellow Wagtail, Grey Wagtail, Tree Pipit, Meadow Pipit, Skylark, Yellowhammer, Bunting, Sparrow, Tree Sparrow, Chaffinch, Greenfinch, Hawfinch, Bullfinch, Goldfinch, and Linnet.

of it is illegal, for though the legislation in favour of birds is for the most part satisfactory, the means for enforcing it are utterly inadequate, and it is to be feared that it has little effect in the more remote parts of the country. Thus I was recently informed that three separate parties, armed with ropes, and intent on robbery, arrived simultaneously at the eyrie of a pair of birds, whose eggs were under the protection of the local County Council; and in another district, where a few pairs of goldfinches still nest, the young are always taken, the regulations in their favour being entirely disregarded.

As a further comment on the Act it may be stated that, whilst the measures taken to protect rare and diminishing species cannot possibly be too stringent, legislation in favour of many common birds, and especially those which are increasing in numbers, is entirely unnecessary and in some cases undesirable.

The following additions and corrections to the previous papers may be noted here :—

**Kestrel.**—Hawks, owls, and many other birds eject the indigestible portion of their food in the form of pellets or castings (see Part I.). Some hundreds of these castings, examined by me, were composed as usual almost exclusively of the remains of mice and beetles, but I was surprised to find in some, picked up in North Yorkshire, the fragments of several earwigs. It would, probably, be a difficult matter to convince the average gamekeeper of the truth of this statement.

**Barn Owl.**—In a casting of this bird I found the bones of a frog.

**Blackbird.**—The berries mentioned in Part I. as being those of the dogwood, were the fruit of the spineless buckthorn. From several notes recently published in *The Zoologist*, it appears that blackbirds, unlike thrushes, do not commonly feed on shell snails. I have found the remains of an earwig in a bird of this species.

**Song Thrush.**—The destruction of wire-worms may be placed to its credit.

**Blue Tit.**—In Part II. it was suggested that the blue tit destroys the buds of trees in its search for the eggs or tiny grubs of insects. This may often be the case, but I am afraid it must be admitted that the buds themselves are sometimes the attraction. On the other hand, scale insects and nut weevils may be added to the list of pests which it destroys, and it also eats the seed of such weeds as horseknop.

**Chaffinch.**—An interesting instance was brought to my notice of a large flock of chaffinches catching quantities of the destructive diamond-back moths on the wing.

PART III.

The Starling, Sheepstare, or Shepster exists in astonishing numbers in most districts, and is increasing rapidly. The glossy plumage of the adult birds is familiar to every one, though the full beauty of its colouring is only apparent on a close inspection. Less known is the dull greyish brown dress of the young, which is entirely devoid of the metallic appearance so characteristic of the old birds. A flock of starlings in a grass field, feeding with restless activity, always conveys the impression of vigour and intelligence, and it is pleasant to watch the birds, for they are extremely useful to the farmer. An examination of the food they contain reveals the presence of wire-worms, leatherjackets, surface caterpillars, chafers and their grubs, many beetles, aphides, flies and their larvæ, with earthworms, snails, and earwigs. They may often be seen gliding through the air in pursuit of insects on the wing, and at times cling to the bark of trees after the manner of woodpeckers. Their habit of perching on the backs of sheep, in search of ticks, is well known, though some shepherds think that their droppings attract the parent flies of the maggots which cause such loss to flockowners.

Such food, however, does not form the whole of their diet, for they take bread, raw and cooked meat with other refuse from houses, and occasionally the eggs and young of other birds. They also eat many wild fruits, for instance the berries of the mountain ash, white beam, and elder, whilst their increasing fondness for pears, plums, and especially cherries, has brought them into disrepute with many fruit-growers. Another charge brought against starlings is that they take corn. At present this tendency is not developed to a very serious extent, but their habits are undergoing a change for the worse, and it is within the bounds of possibility that in the future they may become a serious pest. When looking for a site for their untidy nest and pale blue eggs, they usurp the holes excavated by woodpeckers, and to such an extent that these interesting birds are seriously reduced in numbers.<sup>1</sup> There are many other points of interest about the starling, but it must suffice to add that it is a wonderful mimic, reproducing the notes of the curlew, pewit, thrush, and many other birds with remarkable accuracy.

The Rook, commonly called the Crow in the North of England and Scotland, is not looked upon with favour by the majority of farmers. The amount of harm it does is immense, but it also does a considerable amount of good, and there is, perhaps, no bird to which it is more difficult to assign a

<sup>1</sup> Mr. O. V. Aplin attributes the decrease of nuthatches to the same cause.

character for usefulness or the reverse. There cannot be much doubt, however, that in many districts rooks are too numerous, and that the greater their numbers, the greater is the harm they do in comparison with the benefits they confer. The home-bred birds are augmented by vast hordes, which come to us from the Continent in October and November.

Rooks consume very large quantities of corn, particularly at seed-time, and castings composed entirely of the husk of oats may often be found underneath the trees of a rookery. They also do considerable damage at harvest, and not unfrequently attack ricks left in the field. It is advisable, however, to open any rooks shot on newly sown land, for they often contain a quantity of wire-worms or other grubs, with only a few grains of corn. There is, too, a simple method of preventing depredation, for a dressing of tar applied to the seed corn has proved very effective. Perhaps the most annoying injury caused by rooks is the destruction of potatoes, which they unearth at seed-time as well as later in the season. They also pull up acres of turnips after they are singled, though in this case they are undoubtedly looking for grubs; and in winter peck holes in the roots, causing them to rot. Walnuts have a great attraction for them, and the same may be said of cherries and other fruit. Their taste for eggs is now well known; many nests of game-birds are plundered, and there can be little doubt that the eggs and young of skylarks and other ground-building birds share a similar fate.

As is usually the case, the harm done by the birds is obvious, and it is possible to form an approximate idea of the damage. On the other hand, the good they do often escapes observation, and it is impossible to estimate the value of their services. It may, however, be pointed out that a very large proportion of their time is spent on grass fields and on newly ploughed land, where their presence can only be beneficial, and that they consume enormous quantities of wire-worms, leatherjackets, cockchafer grubs, slugs and surface caterpillars, as well as earthworms, clickbeetles, daddy longlegs, and other insects of all sorts and descriptions. Some of the insects are no doubt useful, for instance the ground-beetles which prey upon other species, and it appears that rooks eat a considerable quantity of them. A complete list of the food of the rook would comprise almost every edible substance, for it is practically omnivorous, devouring carrion, bread, feeding-cakes, bone-meal, fish, shell-fish, small birds—even lapwings—the fleshy roots of couchgrass and other plants, maize, acorns, beechmast, and bilberries. An interesting account of an organised hunt for field mice by a flock of rooks appeared in *The Zoologist* for 1892, and I have taken the remains of

these pests from the stomachs of young birds. Like other members of their family, rooks are very intelligent, and very soon realise the harmlessness of clock-guns and other devices intended to scare them. They use their brains, too, when hunting for food, and I was once much amused to see a rook in a pasture field lift up a fairly large stone with its bill to see if there were any worms or other delicacies underneath.<sup>1</sup>

The **Carrion Crow** or **Corbie** does not nest in colonies, as the rook does, and the base of the bill is feathered, whereas in the adult rook that portion and the face are bare. The two birds differ in other particulars, notably in voice, that of the crow being particularly harsh and, one is almost inclined to add, insulting. It is a most destructive bird to game, and a basketful of sucked eggshells may be picked up in the neighbourhood of its nest. It takes a certain amount of vegetable matter, but feeds chiefly on carrion, animal matter of all sorts, including young rabbits, leverets, small birds, and insects, and at times destroys weakly ewes and lambs. The **Grey, Hooded, or Royston crows**, so conspicuous in some of our eastern counties in winter, are identical with the carrion crow in every respect, except that the plumage of the body is grey, in striking contrast with the black head, wings, and tail.

Amongst a flock of rooks there are generally a few **Jackdaws**. They may be distinguished from their relatives by their smaller size and in adult plumage by the grey feathers on the sides and back of the neck. Jackdaws eat a quantity of snails and insects, but they are very mischievous, devouring eggs, young birds, corn, and fruit. Like the starling they frequently perch on the backs of sheep, and pursue flies on the wing.

It is a great pity that the **Magpie** is so destructive to game. Many people, seeing it only at a distance, speak of it as a black and white bird; such a description is, however, very inadequate, for the blue, green and purple reflections which enrich its plumage combine with the graduated tail and the strong contrast of the snow-white markings to make the magpie one of our handsomest birds. It destroys quantities of eggs and young birds of all kinds, and, like the rest of its family, will eat almost anything. To the farmer and fruit-grower it renders considerable service by destroying insects, rats, mice, and the eggs of woodpigeons and many fruit-eating

<sup>1</sup> The Transactions of the Highland and Agricultural Society for 1896 contained an account of an investigation by Sir John Gilmour, Bart., aided by Professors M'Alpine, Campbell, and Seton, on the food of rooks, woodpigeons, and starlings, throughout the year. The contents of 336 rooks were examined, and the result was very unfavourable to the birds, grain and husk being found in 290 of them.

birds. It feeds upon the parasites of sheep, and has been credited with the destruction of warble maggots in cattle, though I am unable to find any satisfactory reference to this point. The large and conspicuous nest is surrounded by thorny sticks, and is further protected by a dome of the same material. The belief that there are two species of magpie, one building in hedges, the other in trees, is without foundation.



FIG. 1.—Magpie (*Pica rustica*).<sup>1</sup>

The most striking adornment of the **Jay** is a patch of lovely blue feathers on the wing, though the rest of the plumage is of almost equal beauty. Jays receive, not unnaturally, much attention at the hands of gamekeepers, partly because they consume large quantities of pheasant food, and partly because

Figs. 1-6 are from Yarrell's *British Birds* (Gurney & Jackson).

they take the eggs of game, though they are probably less destructive in this respect than magpies. Their fondness for acorns and beechmast is well known, whilst their visits to gardens occasion much annoyance, for they strip the pods of the peas from end to end of the rows in the most mischievous manner. Those who have suffered in this way describe the note of the jay as harsh and disagreeable, and it must be admitted that the first epithet is sufficiently correct.

The Swallow and the Martin appear in spring after passing the winter in Africa. They are often mistaken one for the other, but may be readily recognised, the swallow by its

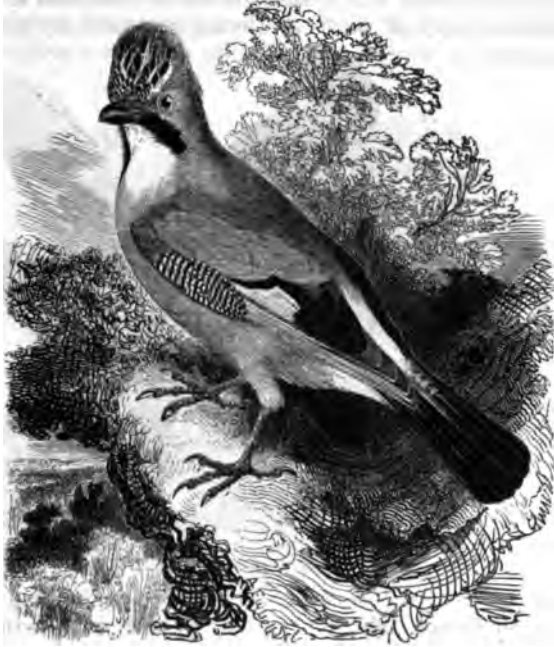

FIG. 2.—Jay (*Garrulus glandarius*).

chestnut throat, blue upper parts, and the long outer feathers of its forked tail, and the martin by the white patch on its back. The nest of the swallow is almost always supported from below, for instance by the timbers of a roof, and is open at the top; that of the martin is most commonly fastened to the wall of a house underneath the eaves, and only a small hole is left for entrance. Both species feed on winged insects of all sorts, and doubtless make no distinction between useful and injurious kinds, but on the whole they are invaluable and are amongst the few birds of which we could hardly have too

many. Swallows catch the annoying horse-flies, or "clegs," as they are called in some districts; and I had the pleasure of finding the unmistakable wing-cases of "turnip-flies" amongst a mass of insect fragments beneath the nest of a martin. The little brown Sandmartin may be readily distinguished from the martin by its brown colour and the absence of the white patch above the tail. Every one has seen the tunnels bored into sandy banks by these little soft-billed birds, and their excavation is a remarkable achievement. Though swallows and martins prey chiefly upon small insects such as gnats, they will at times take much larger game; thus there is the testimony of Gilbert White that young sandmartins are fed on dragon-flies nearly as large as themselves, and an instance is



FIG. 3.—Martin (*Chelidon urbica*).

recorded<sup>1</sup> of a martin seizing a crimson underwing moth, a much bigger insect than the familiar yellow underwing.

The Swift, Screecher, or Deviling resembles the swallow and martin in its habits and appearance, though it has no real affinity with them. It is characterised amongst other things by the fact that all the four toes of its little feet are directed forward. On the wing its sooty plumage, large size, dashing flight, and screeching note make its identity sufficiently evident. It feeds entirely on insects.

In the dusk of the evening one may see the beautiful flight of the Nightjar, Fern Owl, or Goatsucker as it hawks for moths, cockchafers, and other beetles; the white spots on the

<sup>1</sup> *The Birds of Devon*, D'Urban and Mathew, p. 59.



wings and tail of the male showing conspicuously in the waning light. It is about ten and a half inches in length, and its softly blended plumage of grey, brown, and buff harmonises perfectly with the surroundings amidst which it passes the day, for instance, with the trunk of a fallen lichen-covered Scots fir on which I saw one lying, for the nightjar rests lengthwise on a bough, and not across it, as most birds do. It is a remarkable bird in many ways; its unobtrusive bill, when opened, has a surprising capacity, and its effective width is increased by the surrounding bristles; it has a comb-like claw on the middle toe; its two beautiful creamy white eggs, blotched with brown and lilac-grey, are laid on the ground without the slightest pretence of even a hollow scratched for their reception; and its loud churring note is distinct from



FIG. 4.—Nightjar (*Caprimulgus europæus*).

that of any other British bird. It is unfortunate that some unwise person once gave the name of Night Hawk to this species; the designation has been quite enough to cause unintelligent game-preservers, by no means a limited class, to destroy these delightful birds. A glance at their soft bills and feeble feet renders the idea that they take game as ridiculous as the fable that they suck the milk of cows and goats.

Though the note of the Cuckoo is familiar to every one, there are many who do not know the bird by sight. It is

about thirteen inches in length ; the back is grey, the underparts white barred with black, and the tail nearly black with white spots. In general appearance it bears some resemblance to the sparrow-hawk, and this fact, together with the departure of cuckoos at the end of summer, and the subsequent arrival of migrating hawks, has given rise to the saying, "Cuckoos turn to hawks in winter." This absurd idea is exactly comparable with the opinion, still prevalent, that rye-grass turns into couch or "wicks."



FIG. 5.--Cuckoo (*Cuculus canorus*).

The cuckoo, of course, makes no nest, but deposits its egg in that of some other bird. The variation in the colour of the eggs is remarkable, but they all resemble those of some small bird, for instance the various wagtails, pipits and some warblers ; whilst there is even a blue variety similar to the eggs of the hedge-sparrow and redstart. The egg is

not always placed in a nest with others which match it, on the contrary, it often forms a striking contrast with them. The cuckoo, doubtless, selects a nest with eggs resembling its own if it can find one, but otherwise contents itself with that of any small bird. It lays its egg on the ground, and then carries it about till a suitable nursery is found, and more than once a cuckoo has been shot with its own egg in its bill. Such incidents may have given rise to the widespread belief that they suck the eggs of other birds; that they habitually do so is, however, improbable, though they will remove one or more eggs from a nest to make room for their own. The fact that



FIG. 6.—Ringdove (*Columba palumbus*).

the young cuckoo itself ejects the eggs or young of its foster-parents is now well known. I once replaced the eggs of a titlark, which had suffered this fate, in the hope of seeing the performance repeated. The young cuckoo was not successful whilst under observation—though the eggs were again outside the nest next day—but its method of working was sufficiently demonstrated. It endeavoured to climb backwards up the side of the nest, keeping the egg on its back by stretching out its undeveloped wings. It was not a pretty sight. The food of the cuckoo consists of beetles and other insects, including

hairy caterpillars—even the woolly bear—and it frequently visits gooseberry bushes to feed on the destructive grubs of the saw-fly.

The Ringdove, Woodpigeon, Quest, or Cushat, is both very abundant and very destructive. The home-bred birds are sufficiently numerous, but their numbers are augmented in autumn by vast flights from the Continent. They do great damage to corn, beans, peas, and vetch-seed, and in spring destroy a quantity of clover by pecking out the heart of the plant. They feed also on the leaves and roots of turnips, the leaves of ribgrass, buttercup, lesser celandine, grass, and many other plants, and on acorns, beechmast, hazel-nuts, holly berries, bilberries, and the seeds of charlock, dock, and other weeds. Even the ringdove, therefore, is not always doing harm. I was once walking through a clover field in June with a farmer, who said, "Look at those woodpigeons eating my clover"; on my suggestion he shot four of them, and their crops were crammed with the seeds of chickweed, and contained only a leaf or two of clover. A few other substances eaten by pigeons are mentioned in the table at the foot of this page.<sup>1</sup>

The Stockdove, often incorrectly called the Rockdove or Blue Rock, lacks the white patch on the neck which characterises the adult ringdove, and it is also a smaller bird, the lengths being thirteen and a half and seventeen inches respectively.

<sup>1</sup> The paper in the Transactions of the Highland and Agricultural Society for 1906, already alluded to, contains the following interesting table:—  
Pigeon Foods arranged in order of Importance (245 Ringdoves examined).

From Crops	Number of times taken	From Weeds	Number of times taken	From Trees	Number of times taken
Barley grains .	81	Charlock and runch		Elm fruit .	18
Clover leaves .	41	leaves . . . . .	22	Beech nuts .	12
Turnip and swede leaves	38	Spurrey fruits .	11	Beech flowers .	11
Oat grains .	29	Charlock and runch		Elm flowers .	2
Potato tubers .	23	flowers . . . . .	9	Wild cherries .	2
Bean seeds .	14	Cruciferous seeds .	7	Oak leaves .	1
Wheat grain .	12	Buttercup flowers .	6	Haws . . . . .	1
Turnip and swede roots .	6	Dock fruits . . . . .	6		
Grass seeds .	4	Speedwell fruits .	4		
es . . . . .	2	Chickweed fruits .	3		
rye-grass seed	1	Pilewort roots . . .	2		
Rye grain . . .	1	Buttercup leaves .	1		
Maize (artificial food) . . . . .	1	Annual meadow-grass flowers .	1		
Pea seed . . . . .	1	Goosegrass seed . . .	1		
Total . . . . .	<u>254</u>	Total . . . . .	<u>73</u>	Total . . . . .	<u>47</u>

is food is similar to that of the ringdove, but perhaps includes larger proportion of charlock and other weed seeds.

The true Rockdove is about the same size as the stockdove, but may be distinguished from it by the presence of a white patch on the back and two distinct black bars on the wing. It nests in caves and is almost entirely confined to the neighbourhood of the coast. Corn, when obtainable, is its favourite food, but weed seeds and the roots of couch are also taken.

The small and pretty Turtledove is a summer visitor to this country. Its food appears to consist chiefly of grain and seeds, and Dr. Sharpe states that both this species and the stockdove do great damage to mustard fields when the seed is ripe.

In moderate numbers Pheasants do no appreciable damage, but when very abundant the harm they do is serious. They trample down corn and feed upon it at seed time as well as in the stook, and attack potatoes and root crops. Quantities of injurious grubs are, however, destroyed by them, and many hundreds of both wire-worms and leatherjackets have been found in the crops of single birds. Though they thus eat the produce, desirable and undesirable, of arable land, the bulk of their food is obtained in the woods. It is of a most varied description, and includes acorns, beechmast, maize, hazel-nuts, the stones of wild cherries, holly berries, yew berries, rose hips, and hawthorn berries; the leaves of the buttercup, daisy, primrose, woodsorrell, stellaria, bedstraw, clover, fern, and grass; the shoots of sedge; the roots of buttercup and anemone; the seeds of chickweed, bindweed, scabious, bluebell, sedge, buttercup, plantain, hempenettle, grass and fir cones; and quantities of the spangle-galls from oak leaves, slugs, snails, worm cocoons, ants' eggs, daddy longlegs, the wingless female of the mottled umber moth, beetles, caddis-flies, and the large grubs of a two-winged fly named bibio. All the above are within my own experience, and the list might be considerably increased, for instance by the addition of buckwheat, bilberries, blackberries, and the seeds of rush. A pheasant's crop often contains a very varied mixture; thus one yielded 278 bibio grubs, 100 fir cone seeds, about 12 tiny snails, yew berries, a quantity of fern leaves, buttercup leaves, blades of grass, and other unrecognisable material, including, I believe, a sloe. Some young birds, killed by a grassmower, contained caterpillars, beetles, aphides, and several seeds, including those of the plantain and buttercup. The powerful flight and wiliness of the cock pheasant, at any rate late in the season, make it a fine sporting bird, though there is usually an air of artificiality about it which detracts from its merits; and to the ornithologist at least it is a poor substitute for the many delightful birds destroyed in its real or supposed interest.

If the **Partridge** were a mischievous bird, it would still be a general favourite. Luckily, however, the damage it does is not great, and ample reparation is made by the destruction of injurious insects. Partridges feed on corn, the seeds of grass, plantain, hemp-nettle, and many other weeds; the leaves of such plants as winter rye, grass, clover, and buttercup; grass-hoppers, flies, beetles, ants, ants' eggs, and caterpillars; whilst a chick, accidentally killed in a hayfield, contained a spider, a saw-fly grub, tiny weevils, cuckoo-spit insects, aphides, the slug-shaped chrysalis of the syrphus fly, various flies, beetles, and grubs, with many seeds of ribgrass. When reared by hand partridges become very tame, and I have seen such birds run over the body of an old retriever lying in a doorway. Mr. Ogilvie Grant has pointed out that the well-known chestnut horse-shoe on the lower breast is by no means a reliable indication of the sex of the birds, but that this point may be settled with certainty by the smaller feathers of the wing, which in the cock bird have a light stripe down the centre and no other light markings, whereas in the hen there are pale cross bars in addition.

There is no bird so universally appreciated by farmers as the **Pewit**, **Lapwing**, or **Green Plover**. It does no harm whatever, except, perhaps, the occasional destruction of some useful insect. Like the magpie, a distant view of the pewit gives the impression of a black and white bird, but the upper parts are really green, glossed with purple and bronze, and the feathers next the tail, both above and below, are a beautiful fawn colour, whilst the graceful crest gives a distinctive charm to its appearance. The large flocks of lapwings, often composed of immigrants from the continent, feed both by day and night, and devour slugs, surface caterpillars, the caterpillars of the small cabbage white butterfly, leatherjackets, wire-worms, and earwigs; as well as worms, beetles, and caddis-flies. On the sea-shore they obtain marine insects, and small shellfish. The late H. A. Macpherson saw lapwings catching flies on the wing, "pursuing the insects in graceful undulating curves."

**Seagulls** are usually regarded as welcome visitors to the farm. The larger gulls destroy quantities of eggs, principally of sea-birds, and one of them, the **Great Blackbacked Gull**, occasionally attacks weakly ewes and lambs, but they are of no great importance to the farmer. Of the smaller gulls, the **Common Gull** and the **Blackheaded Gull** are the best known. The blackheaded gull has red legs and feet, and in the summer a black, or more correctly brown, head; the common gull has greenish-yellow legs. The food of both species is probably similar and is of a very varied nature. A most interesting report on the blackheaded gull, by Mr. D. L. Thorpe and

Mr. L. E. Hope,<sup>1</sup> gives a very good idea of its usual diet, and I am very glad to avail myself of the information contained, for I am not sufficiently hardened to shoot seagulls. The investigations extended over a period of thirteen months, and a hundred birds were examined. Earthworms proved to be the food most frequently taken, with wire-worms, leatherjackets, beetles, mayflies, oats, grass, turnips, and other vegetable matter. One bird contained thirty slugs, whilst moths and their caterpillars, spiders, sandhoppers, cockles, and carrion were observed in others. Fish did not form a large proportion of their food, in fact only nine birds contained fish of any description. Complaints had been made that the gulls took seed corn, but any loss is confined to

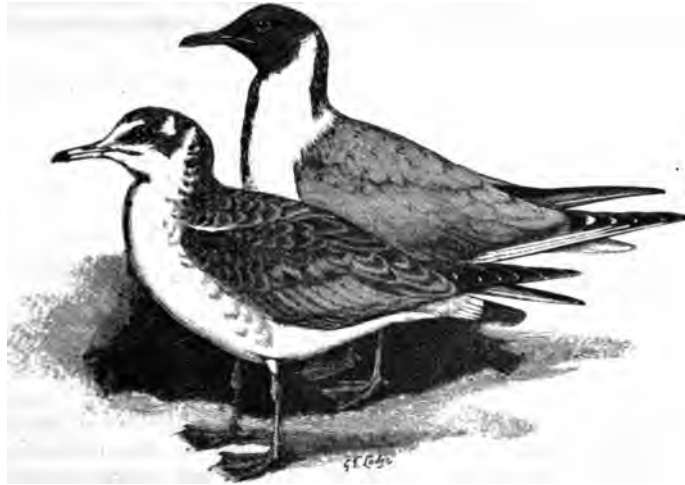

FIG. 7.—Blackheaded Gull (*Larus ridibundus*).<sup>2</sup>

“a period of two or three weeks, and occurs only while the grain is actually being sown by those farmers who sow broadcast. Those who use the drill do not complain, and it appears that, if the grain is covered immediately, little or no damage is done, as the bird does not uncover it.” It is interesting to find that, out of the hundred gulls examined, no less than thirty-six contained wire-worms or their parent beetles—one contained fifty—and fifteen contained leatherjackets. From other sources of information it appears that the blackheaded gull frequently preys upon daddy longlegs, sometimes, as observed by Mr. R. Newstead,<sup>3</sup> taking them by thousands. Mice, winged ants, and earwigs are also captured by seagulls,

<sup>1</sup> Carlisle, June, 1907.

<sup>2</sup> Fig. 7 is from Saunders' Manual (Gurney & Jackson).

<sup>3</sup> *The Gardeners' Chronicle*, January 21, 1905.

and it is evident that the general belief in their utility is abundantly justified.

This short paper must now be brought to a conclusion. The sins of omission are many, but I trust there are no incorrect statements. It would have been a pleasure to me to acknowledge the sources from which I have drawn information, but I have ransacked all the writings of competent ornithologists on which I could lay my hands, and the list would be so long that it would suggest the mountain bringing forth the mouse. I am, however, glad to take the opportunity of expressing my gratitude to my colleagues, Wm. G. Smith, Ph.D., and T. H. Taylor, M.A., who have always been most patient in identifying seeds, insects, and various animal and vegetable fragments taken from the crops or stomachs of wild birds.

CHARLES F. ARCHIBALD.

The University, Leeds.

---

## INJURIOUS FODDER AND POISONOUS PLANTS.

### INJURIOUS FODDER.

THE discriminating powers of the natural instinct of animals in selecting their food are quite reliable, but the animals cannot always make free use of these marvellous qualities, especially when there is no choice of food, or when unnatural conditions prevail and the animal finds itself in a starving condition. The first clause of this statement applies to all animals that are fed in their stables by means of dry or prepared food given at regular intervals. Though the food thus given to animals may possess properties disagreeable or unpleasant, and cause them to reject it instinctively, the hunger which soon makes itself felt, overcomes all instinct and the animal devours its food, wholesome or not. The food provided for animals should therefore be of a wholesome nourishing character and be devoid of any properties causing disturbance of the natural functions and thus becoming deleterious to the health.

An important kind of unwholesome food is hay which is damp or which has been damp, though it may be quite dry when offered to the stock. The quality of the hay is much



deteriorated when heavy rain has saturated it,<sup>1</sup> but still more when the meadows from which the hay is obtained have become flooded. Whilst the former washes out especially those valuable ingredients which are of a light digestible nature, the latter spoils the hay by the particles of soil or mud adhering to it. It has been recorded that this kind of hay causes trouble in the digestive organs, the mud particles with the hay forming hard balls in the stomach of the animals; thus producing symptoms of obstruction or other considerable damage. If hay of this description has to be used it should be thoroughly dried and the quantity necessary be put in a sack and beaten; much of the dried mud would thus be removed. It is still better to put it through a cutting machine and mix it with molasses or other artificial feeding-stuffs.

In the same way as a farmer would not think of giving his animals water to drink too cold or too hot, he should avoid giving frozen roots as food. In many cases this has proved itself a serious mistake. Low temperatures causing catarrh of the stomach, "blowing," diarrhoea, and in cows abortion.

Another important factor which renders food noxious is the presence of microscopic vegetable organisms, as for instance the parasitic fungi attacking plants or the non-parasitic fungi, commonly known as "moulds."

Amongst the parasitic group the ergot fungus on grasses takes the first place. This fungus formed the subject of an interesting memoir by Mr. Carruthers,<sup>2</sup> and its detailed description can be dispensed with here. A passage in that paper emphasises the remarkable action of ergot on the gravid uterus, which has caused it to be used for many years as a powerful aid in cases of difficult or prolonged parturition, and elsewhere he refers to ergot as the cause of abortion.<sup>3</sup> Numerous instances of the same trouble could be mentioned. Mr. Batho, writing in one of the earlier volumes of this Society's Journal,<sup>4</sup> says that he cannot give an exact reason why great losses have occurred from abortion, but it is probably due to the grasses of the meadow being affected by ergot. A drastic case of poisoning by ergot is known to me where a horse had been feeding on infested hay of ryegrass. On the

<sup>1</sup> Much too little attention is paid to this matter. Hay, especially in wet seasons like the present, is very much inferior. Since this article was written a case came to my notice where damp hay, of this year's harvest, was given to 16 horses, and all lost their appetite, their usual brightness, and the general condition was much impaired. Soon after changing the hay for better, the animals rapidly regained their old strength and soon recovered their natural brightness.—(Nov., 1907, *H. T. G.*)

<sup>2</sup> Journal R.A.S.E., 1874, page 443.

<sup>3</sup> *Ibid.*, 1886, page 327.

<sup>4</sup> *Ibid.*, 1884, page 529.

day following the hind limbs became stiff and moist with cold sweat. During the following two days the legs were badly swollen and symptoms of the dreaded gangrenous disease made

their appearance. The death of the animal took place on the fourth day. The first signs of ergot poisoning are fatigue to such extent that the animals cannot be used for work. Then cold sweats make their appearance and paralysis of the tongue and the muscles used in swallowing sets in; later the whole body is similarly affected. In some cases death resulted within ten hours and in others on the fourth or fifth day. From the varied doses of ergot given by the physician it is evident that some organisms can stand much larger doses of the poison than others. From 15 to 60 grains can be given to a man, though even the smaller dose has caused serious poisonous symptoms. The ergot "grain," which is the hibernating stage of the fungus, *Claviceps purpurea* Tul., is almost exclusively found on grasses. All pasture grasses and also those growing on roadsides are liable to an attack of the fungus. The grains are formed generally after the time of flowering is over and it is thus desirable to mow the grasses early, when they are in flower.

The presence of the ergot fungus is much more easily traced in the hay than any other. The grains protrude from the glumes of the grasses (see Fig. 1.), being of much larger size than an ordinary seed and of bluish black colour. If a quantity of hay is suspected to contain ergot, it can be detected by the simple means of shaking several lots of it well over some paper spread on the ground when some of the ergot grains will certainly drop out and be noticed.

The smut fungi (*Ustilagineæ*) of our cereals and grasses, especially the fungus known as bunt (*Tilletia Caries* Tul.) have

FIG. 1.—Rye, *Secale cereale* Linn., bearing ergot grains.



proved extremely dangerous to animals of the farm. After feeding on hay which contains the spores of these fungi (often in enormous masses, so that they form clouds

of black dust, when the grain passes through the machine) inflammation of the mucous membrane, laboured action of chewing, flow of saliva, and occasional abortion have resulted.

Fungi of the genera *Puccinia* and *Uromyces*, common enough on grasses, have caused similar symptoms though less in severity. Hay and straw containing these fungi are better not given to animals or at least with great care and precaution. Nothing but a microscopical examination can detect the presence of these injurious organisms.

*Uromyces Trifolii* Wtr. and *Erysiphe Martii* Lev., two fungi attacking clover, are frequently present in clover hay. Hay badly infested by these fungi, causes, when eaten, "blowing," flow of saliva, and sometimes symptoms of a more serious character. The mildew fungus of grasses (*Erysiphe Graminis* D.C.) occurs also often in hay, and produces when present in abundance inflammation of the urinary, genital, and digestive organs, in some cases hæmaturia and abortion.

In the case of giving potatoes, attacked by the fungus *Phytophthora infestans* De Bary, to animals, the question of the deterioration in the tuber is invariably involved. It has been found that the fungus itself causes no ill effect. The tubers, however, are known to decay rapidly from the action of putrefactive bacteria, and thus become dangerous as food, causing in this condition disturbances of digestion in the animals.<sup>1</sup> It has not yet been investigated what effect upon the animals is produced by the organisms causing "bacterial rot" of swedes and turnips, but while these organisms may be harmless the quality of the roots is thus so reduced in its feeding value that they become quite useless. Scores of other fungi are known to produce similar loss of nutritive matter, for instance *Phoma Bete* Frank, occurring on mangolds, the still little known fungus described as "potato canker fungus" (*Edomyces leproides* Trab.), the "acid" and "dry" rot of the potato,<sup>1</sup> &c. All these fungi produce through their action large quantities of butyric acid which has been stated to cause a decrease of the milk, or even inflammation of the stomach and intestines.

The farmer need not unnecessarily be alarmed at these remarks as affecting the well-known practice of using small and even bad potatoes as "pig potatoes." I am unwilling to commit myself to severe measures recommended by other

<sup>1</sup> Quite recent feeding experiments with potatoes attacked by the Potato fungus and the acid rot bacterium have shown that when given in small quantities no ill effect was noticeable, but in larger quantities diarrhoea was produced in the experimental animals (pigs and cattle). Though these symptoms were not serious, it is also stated that the control animals put on much more readily fat than the others. (*Kais. Biol. Anstalt f. Land und Forstwirtschaft*, Heft 4, February, 1907.)

observers, namely, not to use potatoes or roots which show signs of decay at all; but it will be obvious to every farmer that decayed potatoes possess little feeding value. For what is the food in roots and potatoes that is taken by the animal organism? Is it not the stored food in these itself? Now it is well known that fungi live upon the stored food, and thus the decay results. Such roots or tubers used as food load the stomach with a lot of unnecessary material which has practically been already "digested" and passes through the animal's body without any benefit, to say nothing of the possible disturbances such food has actually caused. Roots or potatoes should therefore only be given to animals when perfectly sound or after the diseased portions have been cut away.

In comparison with the enormous number of fungi causing plant diseases, the cases referred to above certainly appear very few; but while the majority of them have hitherto not been mentioned as having produced any ill effects on animals, it must be clearly understood that every fungus alike renders the plants attacked by it less nutritious, on account of their parasitic mode of life. The non-parasitic fungi, moulds, like *Aspergillus*, *Mucor*, *Penicillium*, &c., also give cause for suspicion. Food which contains even a small proportion of moisture will quickly become mouldy, especially if it is kept some time. The musty smell of mouldy food makes it disagreeable and it is rejected by stock. Wm. Housman<sup>2</sup> attributes premature calving to the results of inferior food and of mouldy hay in particular. Other writers refer diseases of the intestines, constipation, decrease of the yield of milk to the presence of mould fungi in the food.

Alarming as the foregoing notes may appear, the injuries caused by the presence of microscopic fungi in the food of animals principally depend, in the writer's opinion, upon the quantity in which they occur and upon the condition of the feeding animal itself. Old animals possess and make use of their natural instinct and thus fall less victims to injury, but younger animals through lack of intelligence suffer more often. On well-managed farms injuries due to inferior food should never happen, as with very little care they may be prevented. The following points are of practical importance: (1) clean and healthy food; (2) cleanliness of the stables, especially of the manger, where remnants of moist food are often carelessly left, and which decay and contaminate the food given later; and (3) light and fresh air, the best protectors from mould and decay.

<sup>2</sup> Journal R.A.S.E., 1880, page 395.

Before leaving the question of the "dry" and "prepared" food, it will be useful to add a few remarks on the danger of using inferior feeding cakes. Feeding cakes of any kind when stored in damp places readily absorb the moisture and become mouldy. The effect of mouldy cakes on animals is similar, though more severe than of mouldy hay. Severe inflammation of the intestines and the stomach have resulted in many cases; generally, however, the symptoms of lesion from that source are a severe cough, especially in young animals, and a decrease of the yield of milk. The feeding of deteriorated cakes has resulted also in acute poisoning of the nature of a strong narcotic. Dr. Augustus Voelcker, in his Annual Report for 1884, referred to linseed cakes as having been spoiled by mould fungi, thus producing splenic apoplexy, violent purging and finally death of the animals that ate them.

Several cases of poisoning by rape cake containing wild mustard (*Sinapis arvensis* L.), have been from time to time recorded. Professor Tuson draws the following conclusions from cases under his observation: It is a matter of fact that wild mustard seed is an irritant poison, giving rise to inflammation of the stomach and intestines.<sup>1</sup> Professor Simonds, the late principal of the Royal Veterinary College, points out that several rape cakes submitted to him for analysis contained large quantities of charlock. The eating of these cakes was followed by many deaths.<sup>2</sup>

Some cotton seed cakes have also caused disturbances of the digestive organs on account of the large quantity of indigestible seed coats present.

Many more instances of deaths resulting from inferior feeding cakes of all kinds may be quoted, but the cases referred to above should suffice to make stockbreeders more cautious. It is of great importance to examine the interior of the cakes also, for many may appear quite sound externally and be permeated by mould internally.

Cases of poisoning of cows resulting from eating bean meal made from Java beans may here be referred to. The Journal of the Board of Agriculture and Fisheries<sup>3</sup> contains a full report and warns the farmers to exercise the greatest caution before using meal made from any other but the white form of Java beans, the others having produced fatal injury to the animals.

In concluding this section it may be mentioned that injury to the mouth and palate of animals has been caused by the presence in the dry food of hard woody stems of plants like

<sup>1</sup> Journal R.A.S.E., 1875, pp. 516, 517.

<sup>2</sup> *Ibid.*, 1876, page 293.

<sup>3</sup> Vol. 12, page 742 (1906.)

clovers or weeds, especially thistles or the haulms of grasses and cereals that have been cut by machine. Certain seeds have similar properties; they either pierce the gum or lips of the animals, as for instance several species of brome grasses (*Bromus inermis* L., *B. sterilis* L.) or matgrass (*Nardus stricta* L.), or they adhere to the palate or tongue, like wood anemone (*Anemone nemorosa* L.), carrot (*Daucus Carota* L.), bur marigold (*Bidens tripartita* L.), or even the seed pods of the spotted medick (*Medicago maculata* L.), &c. Though the injury is very slight and of the nature of a mere splinter, the animals in trying to free themselves of this inconvenience have caused harm to themselves and other animals by violent nervous kicking.

#### POISONOUS PLANTS.

In dealing with the noxious food that animals meet with when grazing it must at once be said that this mainly concerns poisonous plants. The flora of Great Britain possesses a number of deadly poisonous plants and others of less violent character. Some of the plants referred to grow only locally, others are found everywhere. To deal only with those plants which occur in pastures is not for various reasons an adequate treatment of the subject, for firstly, there are very few treatises available for the farmer which deal exhaustively with the vegetable poisons; further, the number of such plants growing actually on pastures is very small; and finally, many cases of poisoning happen on roadsides and elsewhere. It is therefore important to give a more thorough account of the plants poisonous to animals which are met with in Britain, though one must admit that even in regard to the more poisonous ones there is still room for improvement in our knowledge.

Cases of poisoning by plants are by no means rare in this country or any other, as many an unfortunate farmer can confirm from his own experience. In the following list I have included mainly plants which have a decidedly poisonous action together with some which cause less serious injury to animals. The arrangement which I have followed is according to their natural orders:—

**Ranunculaceæ.** Prevailing quality: acrid, caustic.

I. A.<sup>1</sup>—*Clematis Vitalba* L. (Traveller's Joy). Stem: woody, angular, climbing. Leaves: ovate, entire; leaflets arranged on a common stalk, which acts as a tendril. Flowers: greenish white, loose bunches. June to August. Fruits: conspicuous in autumn and winter by its tufts of

<sup>1</sup> The figures and letters in front of the names refer to the plate and illustration.

PLATE I.

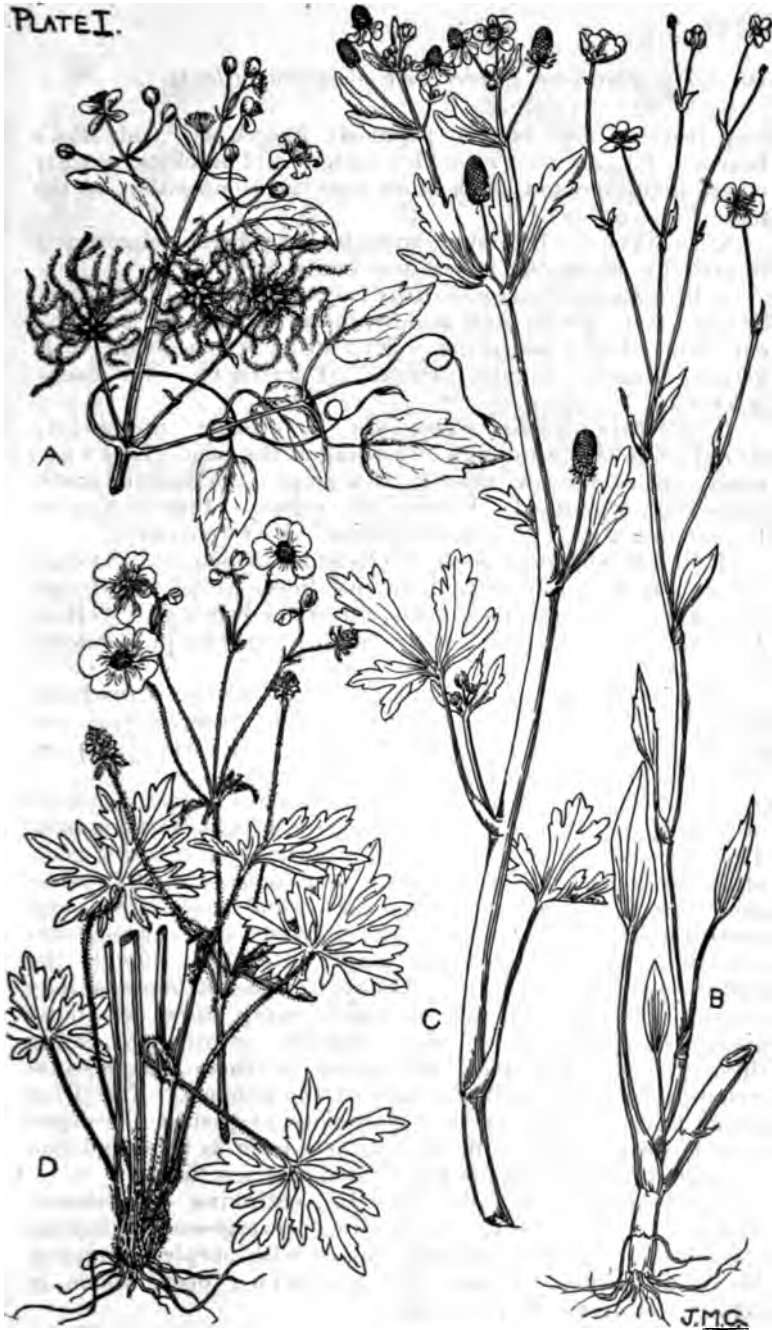

A. *Clematis Vitalba* L. (Traveller's Joy).  
B. *Ranunculus accleratus* L. (Celery leaved Crowfoot).  
C. *Ranunculus Flammula* L. (Lesser Spearwort).  
D. *Ranunculus acris* L. (Meadow Crowfoot).  
(All plants reduced to half natural size.)

long feathery seed vessels, popularly known as "Old Man's Beard." Place of growth: hedges and thickets, mainly where limestone and chalk enter into the composition of the soil. Perennial.

Qualities: Browsing animals have been dangerously injured by eating the leaves and fruits.

I. B.<sup>1</sup>—*Ranunculus sceleratus* L. (Celery Leaved Crowfoot). Stem: 1 ft. to 2 ft. high, hollow, juicy. Leaves: smooth; cut into oblong segments. Flowers: very small, pale yellow. June to August. Place of growth: wet places. Annual.

I. C.—*Ranunculus Flammula* L. (Lesser Spearwort). Stem: 6 in. to 18 in. high; creeping at the base. Leaves: nearly entire, narrow, tapering to a point; the margins sometimes slightly toothed. Flowers: yellow. June to August. Place of growth: in wet places. Perennial.

I. D.—*Ranunculus acris* L. (Meadow Crowfoot). Stem: 1 ft. to 3 ft. high; slender. Leaves: lower—tripartite, deeply cut; upper—narrower segments, linear. Flowers: yellow. June and July. Place of growth: common in meadows. Perennial.

II. A.—*Ranunculus arvensis* L. (Corn Crowfoot). Stem: 10 in. to 12 in. high. Leaves: linear, deeply cut, smooth. Flowers: yellow. June. Fruit: spinous. Place of growth: cornfields. Annual.

Qualities: The above four are the most dangerous plants of this genus, of which all the species contain acrid poison. They are frequently the cause of injuries of stock and grow often in alarming quantities in our meadows. Of lesser spearwort it is said that horses eat it, and cows, sheep, and goats refuse it, but of meadow crowfoot, it is stated, that cows and horses leave this plant untouched, though the pasture be ever so bare. Although these statements may contain a certain amount of truth, many cases are, however, known, where animals suffered greatly by eating these plants. The acrid substances in these plants cause irritation in the digestive organs of the animals. The dried plants have lost part of their poisonous properties, the above four, however, retain sufficient of them even in this condition to cause injury to animals when eaten amongst hay.

II. B.—*Helleborus fetidus* L. (Stinking Hellebore). Stem: 2 ft. high. Leaves: evergreen, somewhat palmate. Flowers: greenish, tipped with purple; drooping. March and April. Place of growth: open woods in marshy districts. Perennial.

<sup>1</sup> The figures and letters in front of the names refer to the plate and illustration.





A. *Ranunculus arvensis* L. (Corn Crowfoot).  
 B. *Helleborus foetidus* L. (Stinking Hellebore).  
 C. *Helleborus viridis* L. (Green Hellebore).  
 D. *Delphinium Consolida* L. (Larkspur).  
 (All plants reduced to half natural size.)

II. C.—*Helleborus viridis* L. (Green Hellebore). Stem: about 1 ft. high. Leaves: digitate, leaflets sessile on short common stem. Flowers: greenish yellow. March and April. Place of growth: like the former. Perennial. (Both plants are doubtful natives of Britain.)

Qualities: The plants contain a narcotic, acrid, poisonous, substance, which, in severe cases, has caused premature calving, in slighter ones collapse, following fits of violent purging.

II. D.—*Delphinium Consolida* L. (Larkspur). Stem: erect, branched. Leaves: deeply multifid. Flowers: blue, rarely pink or white. June and July. Place of growth: on sandy, chalky cornfields. Annual. (Doubtfully native.)

Qualities: The unripe seeds are very acrid, and act similarly to the poisonous principle of foxglove, but more mildly.

III. A.—*Aconitum Napellus* L. (Monk's Hood). Stem: erect, from 2 ft. to 3 ft. high. Leaves: large, deeply cut. Flowers: purple. June and July. Place of growth: banks of rivers; rare. Perennial. (Hardly indigenous.)

Qualities: The whole plant, especially the root, yields a most virulent poison. Aconitine, the poisonous substance, causes dropsy, shortness of breath, convulsions, and finally death by asphyxia.

III. B.—*Actæa spicata* L. (Bane Berry). Stem: triangular, 1 ft. to 2 ft. high. Leaves: stalked, biternate; leaflets ovate, deeply cut. Flowers: in ramose spikes, pure white. May; succeeded in autumn by black shining berries of the size of peas. Place of growth: very local (Yorkshire?). Perennial.

Qualities: A deadly poison. The berries, when eaten, have caused the death of cattle grazing in mountainous regions. It has been recorded that sheep and goats can eat the plants with impunity. Cows, horses, and swine, some observers say, refuse it: but this cannot be universally true.

**Papaveraceæ.** Prevailing qualities: narcotic.

III. C.—*Papaver Rhæas* L. (Common Red Poppy). Stem: bristly, many-flowered. Leaves: pinnatifid, cut. Flowers: large, deep scarlet, often blue black at the base. June and July. Poppy heads nearly globular, without bristles. Place of growth: in cornfields. Annual.

III. D.—*Papaver Argemone* L. (Long-headed Poppy). Stem: short, leafy, many-flowered. Leaves: twice

‡ The figures and letters in front of the names refer to the plate and illustration.

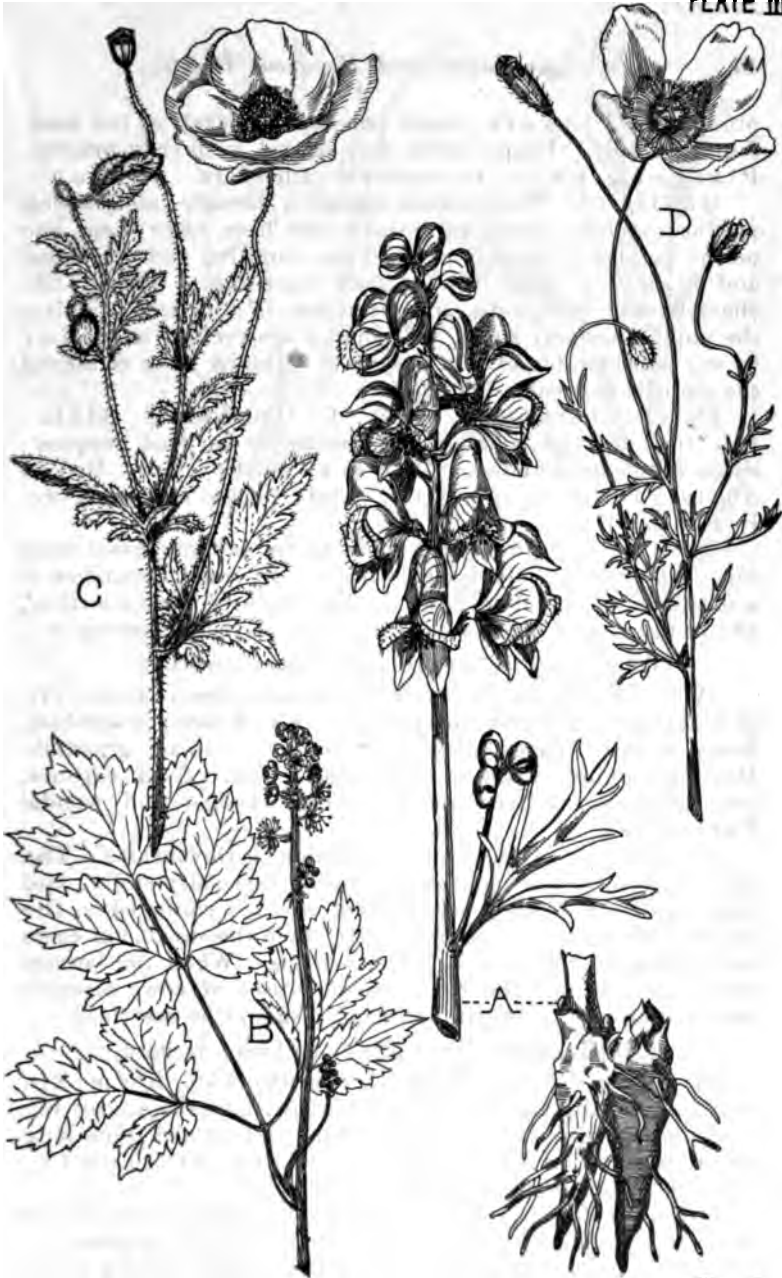

T.M.C.

A. *Aconitum Napellus* L. (Monk's Hood).  
 B. *Actaea spicata* L. (Bane Berry).  
 C. *Papaver Rhoeas* L. (Common Red Poppy).  
 D. *Papaver Argemone* L. (Long-headed Poppy).  
 (All plants reduced to half natural size.)

pinnatifid. Flowers: small, pale scarlet, black at the base. June and July. Poppy heads, club shaped, with erect bristles. Place of growth: in cornfields, rather rare. Annual.

Qualities: The poppies contain a narcotic juice, which produces serious effects on animals that have eaten them, the poison paralyses the animal, produces vomiting and diarrhoea, and in a few days the animals succumb. One of the characteristic symptoms is contraction of the iris, making the pupil extremely small. If poppies are present in the hay to any considerable extent, they have in many cases rendered the animals insensible that ate it.

IV. A.<sup>1</sup>—*Chelidonium majus* L. (Celandine). Stem: 1 ft. to 2 ft. high, smaller, but similar to the true poppies: single segments rounded. Flowers: small, yellow. May to August. Place of growth: waste places, old walls, &c. Perennial.

Qualities: The plant abounds in an orange-coloured juice, which is a violent acrid poison. In small quantities it acts as a purgative, it is, however, known to produce abortion, and in the case of lambs some died a few days after eating it.

**Celastraceæ.** Prevailing qualities: uncertain.

IV. B.—*Euonymus europæus* L. (Spindle Tree), a shrub, 5 ft. to 8 ft. high, with green bark. Leaves: broadly lanceolate, finely serrated edges, glossy. Flowers: small greenish. May and June. Fruit conspicuous, a four-valved capsule, rose coloured. Place of growth: hedges and woods. Perennial.

Qualities: This shrub is common in Devonshire. The berries cause violent vomiting. Sheep especially suffer, and cases have come under observation which terminated in the death of the animals. Horses rarely touch the shrub, but cows seem strangely fond of its young shoots. When the berries ripen cows do not touch the shrub; cases of cows actually poisoned are not recorded, but caution should be exercised.

**Garyophyllaceæ.** Prevailing qualities: irritant.

IV. C.—*Agrostemma Githago* L. (Corn Cockle). Stem: 2 ft. to 3 ft. high, forked. Leaves: narrow, lanceolate, growing together at their base, greyish green. Flowers: on long stalks, purple. June to August. Place of growth: common in corn fields. Annual.

Qualities: The seeds are the most poisonous part of this plant, they contain a poison called saponin, which is prevalent in more or less quantity in nearly all the plants of this order. I have, however, been unable to discover indisputable cases of

<sup>1</sup> The figures and letters in front of the names refer to the plate and position.



A. *Chelidonium majus* L. (Celandine).  
 B. *Euonymus europaeus* L. (Spindle Tree).  
 C. *Agrostemma Githago* L. (Corn Cockle).  
 D. *Bryonia dioica* Jacqu. (Common Bryony) male and female plant.  
 (All plants reduced to half natural size.)

J.M.G.

poisoning resulting from eating any of the other plants. The seeds of corn cockle are frequently present amongst oats, and cases have occurred where horses have been fatally injured through eating them with the oats. It is difficult to separate the seeds from our cereals and they are thus frequently ground together with the grain, contaminating the flour, and making it unwholesome as a food. The plants of this group require further careful study as to their properties; many have been suspected of being poisonous, but as yet experiments with the various plants have given negative results.

**Cucurbitacæ.** Prevailing qualities: purgative.

IV. D.<sup>1</sup>—*Bryonia dioica* Jacqu. (Common Bryony). **Stem:** climbing. **Leaves:** large, light green, rough, having undivided tendrils at the base. **Flowers:** in large white bunches. **May to August.** **Place of growth:** hedges and thickets, rare in the extreme western counties. **Perennial.**

**Qualities:** The plant contains a glucoside, which is an acrid poison. Linnæus reports that goats eat it, horses, cows, sheep, and swine refuse it. If animals have eaten portions of this plant they are seized by fits of purging, their stomach becomes swollen, and a great flow of saliva is observed. It is interesting to note that boiling destroys the poisonous action, and the young shoots of the bryony prepared like asparagus provide a good vegetable.

**Umbelliferæ.** Prevailing qualities: depressant.

V. A.—*Cicuta virosa* L. (Water Hemlock). **Stem:** 3 ft. to 4 ft. high, stout, round and hollow at the base. **Leaves:** on long stalks, tripartite: leaflets linear. **Flowers:** in stalked white umbels. **July and August.** **Place of growth:** ponds and ditches. **Perennial.**

**Qualities:** This plant possesses poisonous principles of the same energy as the true hemlock (*Conium maculatum* L.). The symptoms noticed were swelling of the stomach, succeeded by insensibility, followed by convulsions and death, which in some cases occurred within one hour after eating the plant. Linnæus reports that this plant caused considerable yearly loss of horned cattle, growing on a moist meadow in Sweden. He states that when fully grown this plant has a very disagreeable odour, and is avoided by cattle, but when it is young and grows luxuriantly amongst other herbage, it only has a faint smell, thus it is not detected by the stock, though almost as dangerous in action as the older plants. Linnæus therefore advised the farmers to turn their cattle into this meadow, only after the

<sup>1</sup> The figures and letters in front of the names refer to the plate and illustration.

PLATE V

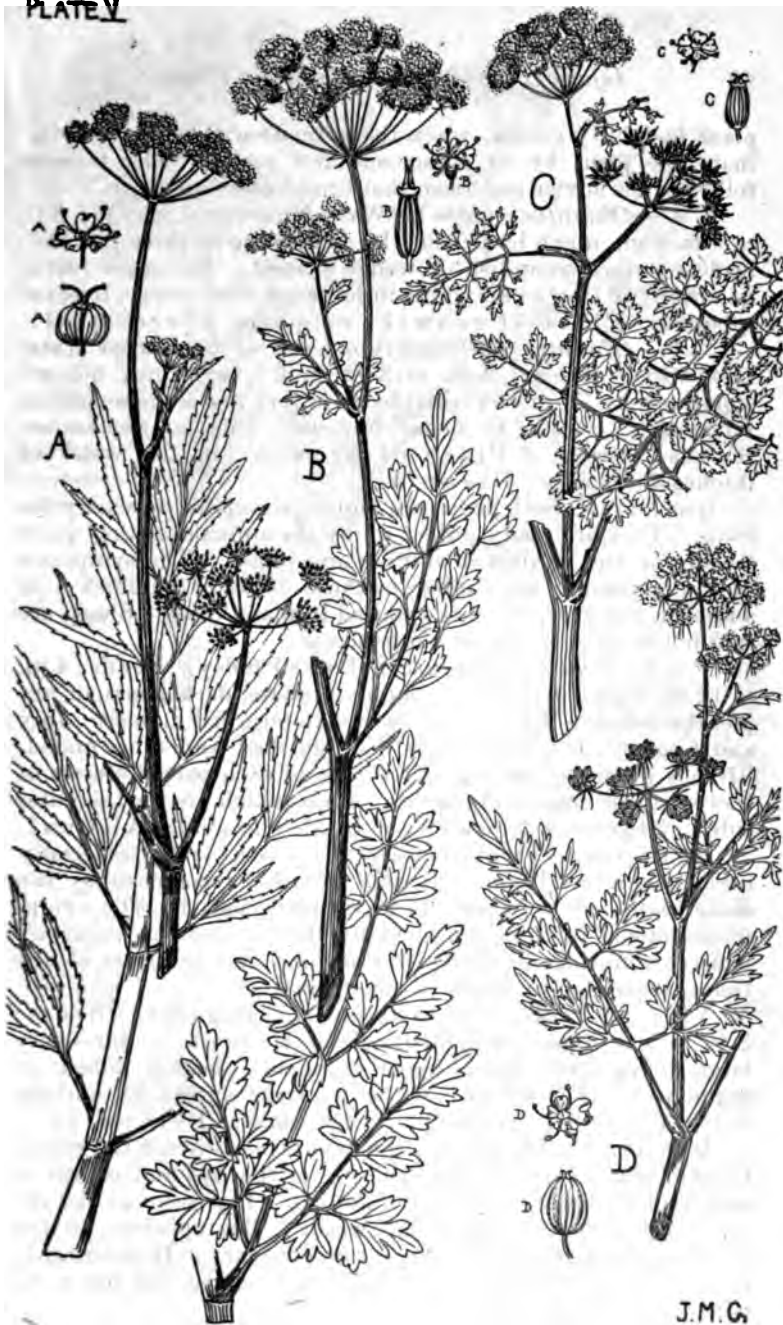

A. *Ciuta virosa* L. (Water Hemlock). A. Flower and fruit  $\times 2$ .  
 B. *Eranthe crocata* L. (Water Dropwort). B. Flower and fruit  $\times 2$ .  
 C. *Eranthe Phellandrium* Lam. (Fine leaved Water Dropwort). C. Flower and fruit  $\times 2$ .  
 D. *Eriusa Cynaptum* L. (Fool's Parsley). D. Flower and fruit  $\times 2$ .  
 (All plants reduced to half natural size.)

J.M.G.

plant had fully grown, when the animals will easily discriminate the plant by its odour and not eat it. The farmers followed his advice and from that time losses ceased.

V. B.—*Enanthe crocata* L. (Water Dropwort). Stem: 3 ft. to 5 ft. high, much branched. Leaves: two to three pinnate; leaflets stalked, roundish or wedge shaped. The upper leaves narrower. Flowers: white, in large umbels. July. Roots: tuberous. Place of growth: wet places. Perennial.

V. C.—*Enanthe Phellandrium* Lam. (Fine Leaved Water Dropwort). Stem: 2 ft. to 3 ft. high; very thick below; stoloniferous. Leaves: divided into very fine acute segments. Flowers: white, in dense umbels. July to September. Roots: fibrous. Place of growth: in the water of ditches and ponds. Biennial.

Qualities: Both plants are highly poisonous, especially the roots. They are easily pulled up by the animals, as they grow loosely on the borders of ditches and ponds. The symptoms of the poisoning are similar to those of water hemlock; in addition, however, blood is vomited in many cases. Sheep are said not to be poisoned by these plants.

V. D.—*Aethusa Cynapium* L. (Fool's Parsley). Stem: 4 in. to 12 in. high. Leaves: doubly pinnate, dark green, of unpleasant odour. Flowers: white, in terminal umbels. July and August. It may be easily distinguished from other umbelliferous plants by having at the base of each partial cluster of flowers three long and narrow leaves, which are on the outer side. Place of growth: cultivated ground. Annual.

Qualities: This plant closely resembles parsley, especially in its young condition. It may be easily recognised by the disagreeable odour when the leaves are crushed. The symptoms noticed in cases poisoned by this deleterious plant are nausea, vomiting, difficulty in chewing, and paralysis of the limbs, succeeded by death in many cases.

VI. A.—*Heracleum Sphondylium* L. (Hogweed). Stem: 2 ft. to 5 ft. high, channelled, hairy. Leaves: lower—very large, irregularly cut; upper—pinnate; leaflets lobed or segmented. Flowers: white in large spreading umbels. July. Place of growth: hedge banks. Perennial.

Qualities: The juice of this plant is very acrid, the symptoms of slight injuries are blistering of the lips and mouth of animals and discharge from the nostrils. Pigs seem to like the plant; hence its name, hogweed. The opinions on the poisonous properties of this plant greatly vary. It is certainly a plant which is injurious to cattle in a degree, but not to be considered a dangerous plant.

<sup>1</sup> The figures and letters in front of the names refer to the plate and illustration.



PLATE VI



A. *Heracleum Sphondylium* L. (Hogweed). A. Flower and fruit  $\times 2$ .  
 B. *Anthriscus vulgaris* Pers. (Beaked Parsley). B. Flower and fruit  $\times 2$ .  
 C. *Conium maculatum* L. (Hemlock). C. Flower and fruit  $\times 2$ .  
 D. *Solanum nigrum* L. (Black Nightshade).  
 (All plants reduced to half natural size.)

E

VI. B.<sup>1</sup>—*Anthriscus vulgaris* Pers. (Beaked Parsley). Stem : erect, 1 ft. to 2 ft. high, smooth. Leaves : thrice pinnate, with blunt segments. Flowers : white, in short stalked umbels. May. Place of growth : waste ground. Annual.

Qualities : The juice of this plant contains a poisonous principle, somewhat milder than hemlock and less narcotic.

VI. C.—*Conium maculatum* L. (Hemlock). Stem : hairless, covered with brownish or blackish purple spots, 3 ft. to 5 ft. high, erect, round hollow. Leaves : finally divided, smooth. Flowers : white, in partial umbels. June and July. Place of growth : hedges, orchards, waste and cultivated ground. Biennial.

Qualities : A plant well known for its highly poisonous properties. One of the first symptoms noticeable is dilatation of the pupil, followed by weakness of the limbs, passing into paralysis, the hind limbs being affected prior to the fore. Later the muscles of the chest and the midriff are affected, and the breathing becomes laboured ; the action of the heart is very irregular, though it continues beating long after the breathing has stopped. Death is preceded by slight convulsions or twitchings of the muscles. Some writers report that though this plant is dangerous, it is by no means so poisonous as water hemlock.

**Solanaceæ.** Prevailing qualities : intoxicant and depressing to the heart.

VI. D.—*Solanum nigrum* L. (Black Nightshade). Stem : herbaceous, 1 ft. to 2 ft. high. Leaves : egg shaped, wavy at the margin, bluntly toothed. Flowers : white, in small drooping bunches springing from the intermediate spaces between the leaves. July to September. Berries : black, globular. Place of growth : waste ground. Annual.

VII. A.—*Solanum Dulcamara* L. (Bitter Sweet). Stem : shrubby, straggling. Leaves : heart shaped, the upper ones eared at the base. Flowers : in loose drooping tufts, purple, two green spots at the base of each segment, with large yellow anthers. June and July. Berries : egg shaped, scarlet. Place of growth : woods and hedges. Perennial.

VII. B.—*Atropa Belladonna* L. (Deadly Nightshade). Stem : herbaceous, 1 ft. to 3 ft. high. Leaves : broadly egg shaped, entire. Flowers : purple, solitary, axillary, on short stalks, drooping. June and July. Berries : violet and black. Place of growth : waste places, rather uncommon. Perennial.

<sup>1</sup> The figures and letters in front of the names refer to the plate and illustration.



A. *Solanum Dulcamara* L. (Bitter Sweet).  
 B. *Atropa Belladonna* L. (Deadly Nightshade).  
 C. *Hyoscyamus niger* L. (Henbane).  
 D. *Datura Stramonium* L. (Thornapple).  
 (All plants reduced to half natural size.)

J.M.C.

**Qualities:** The poisonous properties of these three plants are well known. Deadly Nightshade is one of the most dangerous plants growing in this country; it happily is rare. Numerous instances are known where the berries of this plant have been eaten by children in mistake for cherries. The berries may easily be distinguished by the green leafy calyx adhering to the fruits. Of the other two plants the black nightshade is the less powerful. The poisonous principle in these plants is the alkaloid Atropine. The symptoms of cases poisoned by either of these plants manifest themselves in convulsive spasms, wide dilatations of the iris, so as to produce an enormous sized pupil (note the opposite result is produced in poisoning by poppies). Men and animals having eaten from these plants appear at first as if intoxicated, and rarely are known to recover. The diagnosis of these cases may be confirmed by dropping a single drop of the urine of the animals into the eyes of a young kitten, when it causes dilatation of the pupil.

VII. C.<sup>1</sup>—*Hyoscyamus niger* L. (Henbane). **Stem:** 2 ft. to 3 ft. high, herbaceous, erect, much branched. **Leaves:** large downy, glandular, with an unpleasant fetid odour. **Flowers:** funnel shaped, lurid border; creamy brown, with dark purple veins; centre deep purple. The flowers are arranged in rows along one side of the stem. June and July. **Place of growth:** road sides, not uncommon. **Annual or Biennial.**

**Qualities:** The plant contains a dangerously strong fetid poison, especially when the seeds are ripening. The leaves, however, are less poisonous, than the root or seeds. Stupor and apoplectic symptoms terminating in death are the usual consequences when portions of the plant are eaten.

VII. D.—*Datura Stramonium* L. (Thornapple). **Stem:** erect, 1 ft. to 2 ft. high. **Leaves:** egg shaped, smooth. **Flowers:** white, large, sometimes with a tinge of purple. June and July. **Fruits:** thorny. **Place of growth:** waste places, rare. (The plant is a native of America, but now naturalised in this country.) **Annual.**

**Qualities:** If eaten in small quantities this plant causes vomiting. In larger doses no vomiting takes place; the limbs and muscles become paralysed, and violent convulsions precede death, which almost always occurred in cases, where animals did not soon vomit. The stock shows a great dislike for this plant; it is generally eaten when in the young growth.

**Scrophulariaceæ.** Prevailing qualities: cardiac poison.

VIII. A.—*Verbascum Thapsus* L. (Great Mullein). **Stem:** lower-bearing spikes, 4 ft. to 5 ft. high. **Leaves:** woolly on

<sup>1</sup> The figures and letters in front of the names refer to the plate and illustration.

PLATE VIII.

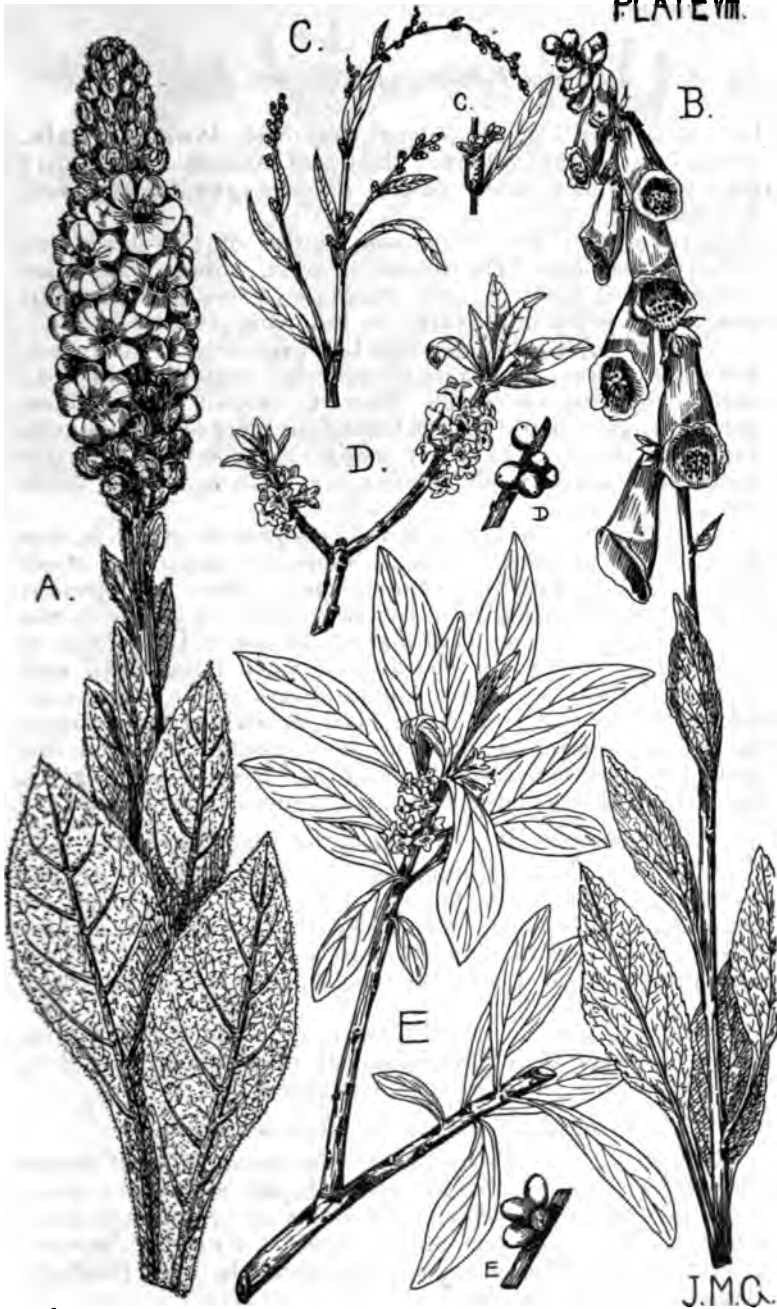

A. *Verbascum Thapsus* L. (Great Mullein).  
 B. *Digitalis purpurea* L. (Foxglove).  
 C. *Polygonum Hydrophyllum* (Water Pepper). C. Flowering portion (nat. size).  
 D. *Daphne Mezereum* L. (Mezereon). D. Round berries.  
 E. *Daphne Laureola* L. (Spurge Laurel). E. Oval berries.  
 (All plants reduced to half natural size.)

both sides, egg shaped, oblong, continued down the stalk. Flowers: bright yellow. July and August. Place of growth: dry ditch banks, gravelly and chalky soil. Biennial.

Qualities: The seeds and flowers of this plant are actively poisonous. The foliage is acrid. Sheep and other animals reject it; it is rarely the cause of serious injury, but acts, though much milder, like the following plant.

VIII. B.<sup>1</sup>—*Digitalis purpurea* L. (Foxglove). Stem: erect, flowering spikes. Leaves: large, egg shaped, wrinkled; stalks embracing the stem. Flowers: thrown up in spikes, purple, thimble shaped, rather beautifully mottled in the centre. June and July. Place of growth: common in hilly districts, on gravelly soil. Rarely met with in the flat land. Biennial.

Qualities: The action of the poisonous substance in this plant is well known. Animals, especially sheep and stock grazing in hilly pastures, seem strangely to have no objection to partaking of this plant. In cases known to be due to the poison of this plant, the nausea and weakness of the animals is pronounced. They are very restless when lying down and frequently vomit. Death is almost always due to strong contraction of the heart. If it has been ascertained that animals have been poisoned by this plant, they should be laid on the ground and prevented from altering their position, as this gives rise to fainting fits and in some cases to instantaneous death.

**Polygonaceæ.** Prevailing qualities: acrid, irritant.

VIII. C.—*Polygonum Hydropiper* L. (Water Pepper). Stem: erect, 1 ft. to 3 ft. high, knotty. Leaves: thin, smooth on both sides, spear shaped. Flowers: in loose drooping spikes, green, red towards the end. August and September. Place of growth: wet places, on the banks of rivers, lakes, and ditches. Annual.

Qualities: The whole plant is acrid and has a burning taste. It produces in animals, though they generally avoid it, urinary troubles, in severe cases hæmaturia.

**Thymelacææ.** Prevailing qualities: irritant.

VIII. D.—*Daphne Mezereum* L. (Mezereon), a small shrub, about 2 feet high. Leaves: spear shaped, narrow, not evergreen as in the next species; preceded by red or purple flowers, often in winter but generally in April. Fruits: berries, globular, red. Place of growth: woods, local (Suffolk, Hampshire). Perennial.

<sup>1</sup> The figures and letters in front of the names refer to the plate and illustration.



A. *Euphorbia Cyparissias* L. (Cypress Spurge).  
 B. *Euphorbia Peplus* L. (Petty Spurge).  
 C. *Euphorbia Lathyris* L. (Caper Spurge), below, portion of barren shoot.  
 D. *Mercurialis perennis* L. (Dog's Mercury).  
 E. *Mercurialis annua* L. (Annual Dog's or French Mercury).  
 (All plants reduced to half natural size.)

VIII. E.<sup>1</sup>—*Daphne Laureola* L. (Spurge Laurel), shrub, 1 ft. to 3 ft. high. Leaves: evergreen, similar to the true laurel. Flowers: yellowish green, in bunches of about five axillary. February to April. Berries: egg shaped, black. Place of growth: woods and hedges; common in Yorkshire. Perennial.

Qualities: Both shrubs are very corrosive. The berries, which can be eaten by birds without any harm are highly poisonous to other animals. The symptoms noticed in animals are purging and vomiting of blood. Linnæus states that six berries produced fatal injury.

**Euphorbiacæ.** Prevailing qualities: powerfully irritant and vesicant.

IX. A.—*Euphorbia Cyparissias* L. (Cypress Spurge). Stem: 6 in. to 12 in. high. Leaves: on the flowering stem, spear shaped, smooth; on the barren stem, slender, fir like. (This kind of leaves distinguishes the plant at once from the other British species of this genus.) Flowers: about seven in a very compact umbel, greenish yellow. May and June. Place of growth: road-sides, local (Westmorland). Perennial.

IX. B.—*Euphorbia Peplus* L. (Petty Spurge). Stem: 6 in. to 10 in. high, erect. Leaves: light green, entire, alternate, bluntly linear. Flowers: yellowish green. May and June. Place of growth: common on cultivated and waste land. Annual.

IX. C.—*Euphorbia Lathyris* L. (Caper Spurge). Stem: solitary, purplish, 1 ft. to 3 ft. high. Leaves: in four rows, opposite, glaucous, linear, oblong. Flowers: yellow in small umbels. June and July. Place of growth: rocky woods, but also on cultivated ground. Biennial.

Qualities: The species of this group possess a milky, acrid fluid, which is an irritant poison. The above three are most severe in their action. In small quantities purging is effected; in larger it causes diarrhoea and colic symptoms, accompanied by swelling of the abdomen. These symptoms generally precede death from spasms.

IX. D.—*Mercurialis perennis* L. (Dog's Mercury). Stem: simple, 1 ft. high, bare at the base. Leaves: stalked, rough, long lanceolate. Flowers: male and female on different plants. Male, in spikes; female, on stalks, generally solitary. Yellow green, small. April and May. Place of growth: woods, hedge banks. The male and female plants rarely intermixed, each kind growing in patches. Little seed is ripened,

The figures and letters in front of the names refer to the plate and illustration.





A. *Urtica dioica* L. (Great Nettle).  
 B. *Taxus baccata* L. (Common Yew).  
 C. *Narcissus Pseudo-narcissus* L. (Daffodil).  
 D. *Colchicum autumnale* L. (Meadow Saffron).  
 (All plants reduced to half natural size.)

the plant perpetuating itself by shoots sent from the roots. Perennial.

IX. E.<sup>1</sup>—*Mercurialis annua* L. (Annual Dog or French Mercury). Stem: branched, 1 ft. to 2 ft. high. Leaves: smooth without stalk, growing close to the stem, spear shaped. Male and female flowers generally on different plants, though some male plants bear a few females. Yellow green. August and September. Place of growth: waste places; rare, local (Norfolk, Suffolk). Annual.

Qualities: Both varieties are dangerous poisons. The latter is less violent in action and rather rarely met with. Dog mercury belongs to our most poisonous herbs, producing rapid, pernicious effects. Nausea, vomiting, flow of saliva are the earliest symptoms noticeable. This plant is noxious to sheep, though as careful an observer as Linnæus reports that goats and sheep eat it. From my own experience I can state that horses, cattle, ewes and lambs have been poisoned by these plants, dying after fits of violent vomiting.

**Urticacææ.** Prevailing qualities: vesicant.

X. A.—*Urtica dioica* L. (Great Nettle). Stem: 2 to 3 ft. high. Leaves: opposite, heart shaped. Flowers: male and female apart on distinct plants. In axillary knotty spikes. June to September. Place of growth: very common weed. Perennial.

Qualities: The whole plant contains an acrid poison, especially the young leaves. I know of no cases where this plant has produced fatal injury after eating. Asses are fond of it. Cows eat the leaves when a little withered and in hay. Other animals refuse it. If animals have eaten of the plant urinary troubles have resulted in many instances.

**Coniferæ.** Prevailing qualities: aromatic; irritant and narcotic.

X. B.—*Taxus baccata* L. (the Common Yew) and *Taxus fastigiata* Ldl. (the Irish Yew) are both highly poisonous, and are so well known that no description is necessary. It may be said that the fleshy part of the berries has no poisonous properties, as I often have proved myself. The seeds, the seed coat especially, however, contain the poison in large quantity. Sheep and other animals are known to have been killed by browsing upon the bark. It is often stated that the "loppings" in a half dry state are most detrimental to cattle. This is easily explained. A yew hedge is generally trimmed in spring, when quantities of the new and tender shoots are cut away and fall to the ground. These young shoots contain a large quantity of the poisonous vice, and animals picking them up from the ground are

<sup>1</sup> The figures and letters in front of the names refer to the plate and illustration.

seriously injured. The principal symptoms are acute inflammation of the stomach and digestive system, but nervous symptoms—such as convulsions and foaming at the mouth—also occur. Cases of yew poisoning are dealt with at some length in the Journal of this Society.<sup>1</sup>

**Amaryllidaceæ.** Prevailing qualities: narcotic, depressant.

X. c.<sup>2</sup>—*Narcissus Pseudo-narcissus* L. (Daffodil). A bulbiferous plant, with long linear obtuse leaves. Flowerstalk hollow, two edged, bearing near its summit a membranous sheath and a single yellow flower with a tube-like nectary, notched and curled at the margin. March and April. Place of growth: woods and thickets. Perennial.

Qualities: The whole plant possesses poisonous properties, somewhat like the following, but cases of poisoning are not so frequent, the plant being less common.

**Colchicaceæ.** Prevailing qualities: narcotic, depressant.

X. d.—*Colchicum autumnale* L. (Meadow Saffron). A plant when in flower in appearance like the garden crocus. The flowers appear from August to October, after the broad dark green leaves have disappeared; they are of a violet purplish colour and have a very long narrow tube. At the time of flowering the seed vessels remain underground, but appear above surface in spring, together with the leaves. Root: a bulb, from 6 in. to 12 in. deeply buried. Place of growth: meadows, rather local, but then in masses. Perennial.

Qualities: The plant is poisonous in all its parts, and a frequent cause of injury to stock. It is said to cause premature calving. The common symptoms are violent purging, difficulty in passing water, which often contains blood. Collapse speedily sets in followed by death.

#### DELETERIOUS PLANTS.

Under certain conditions nearly all the plants described in this report have caused fatal injury and death to stock; some of them, especially those illustrated, are very dangerous, and the farmer should become well acquainted with these plants and eradicate them with the greatest diligence wherever a single plant is found to grow.

The conditions under which stock is injured by poisonous plants are varied. Indeed it has often surprised me that cattle ever touch plants which possess a fetid and disagreeable odour. We have examples where the disagreeable odour occurs only in the mature plant, though the poison is as severe in the young

<sup>1</sup> Journal R.A.S.E., 1892, page 698.

<sup>2</sup> The figures and letters in front of the names refer to the plate and illustration.

ones and it is not unlikely that this is the cause of many of the poisoning cases. Other poisonous plants are eaten by cattle, seemingly without any objection. It is difficult to explain this, but in many cases the hunger of the animals must account for it. When the grasses of the meadows is eaten down and when too many animals graze upon a field, it is only natural that they devour greedily every green leaf they find and in this way many cases of poisoning explain themselves.

Intelligent and observing farmers have made the statement that, though animals have had plenty to eat they will playfully nibble any plant, tree, or shrub, which in some way or other takes their fancy. It has often been observed that cattle seek protection from the sun's rays on hot days under trees, in open woods, or near hedges, which are all places favoured by many of these poisonous plants. On the other hand, when drinking in small streams or ditches, the animals come into close contact with the poisonous plants which frequent wet places. Farmers often complain that the cases of plant poisoning happen to their best or to young animals. The former animals evidently enjoy the best appetite and therefore greedily consume large quantities of herbage; the latter fall victims to their ignorance of the poisonous herbs and their youthful want of moderation. Thus it is well known that plants which are really not poisonous have caused fatal injury and death to young stock. One of the commonest examples of this is chickweed (*Stellaria media* L.). This plant grows abundantly everywhere; it keeps in green leaf till late in the year, and lambs that eat it to excess so as to fill their stomachs have succumbed under symptoms of stoppage in the digestive organs. On examination of the stomach of animals killed by eating this weed it was found in large masses in the stomach and had not been digested. Whether death is due to overloading the stomach, or to the gaseous fermentation of the green vegetable matter, or whether the plants possess poisonous principles when eaten in large quantities is difficult to say. Chickweed belongs to a natural order of plants, some genera of which yield an undoubtedly poisonous substance known as saponin. This poison is present in many plants of this order, but in quantities too small to give rise to suspicion. Similar in action are *Linum usitatissimum* L. (Common Flax), and *Linum catharticum* L. (Purging Flax). They are known to form large fibrous balls in the œsophagus and stomach of the animals. The latter species in addition possesses a substance of the nature of a narcotic poison, and produces purging also. Another plant with purely mechanical properties is crimson clover (*Trifolium incarnatum* L.); it has been found that there is a danger in the use of the

erripe plant. The small hairs in the heads of this clover are so constructed that they collect together and form large and felted balls in the digestive system of animals. Horses and sheep have thus often been killed after eating this clover. Quite recently a case occurred where in the stomach of a lamb were many as forty-nine of these hairballs were found.<sup>1</sup>

A number of plants which cause minor troubles to animals are known and may be quoted by name. *Raphanus raphanistrum* L. (Jointed Charlock), a weed in cornfields, and *Sinapis irvensis* L. (Charlock), are known to cause "blowing," inflammation of the stomach, and flow of saliva, when eaten at the time the seeds begin to ripen, the "oil of mustard" contained in the seeds producing these injurious effects.

The plants of the following list possess objectionable properties; they have been recorded to cause either a decrease in the yield of milk, or give a bitter or unpleasant odour to it and the butter made thereof. Some of them have been blamed for causing diarrhoea and hæmaturia, and some cases are recorded where premature calving resulted from eating "horse tail." These plants must be included in a list of "certainly suspicious" plants, though their records are insufficiently accurate: *Caltha palustris* L. (Marsh Marigold). *Drosera rotundifolia* L. (Sundew). *Hedera Helix* L. (Ivy). *Anthemis Cotula* L. (Stinking Chamomile). *Lactuca virosa* L. (Wild Lettuce). *Ligustrum vulgare* L. (Privet). *Rumex acetosa* L. (Sorrel). *Rumex Acetosella* L. (Sheep Sorrel). *Oxalis Acetosella* L. (Wood Sorrel). *Paris quadrifolia* L. (Herb Paris). *Iris Pseud-acorus* L. and *Iris fetidissima* L. (Flags). *Galanthus nivalis* L. (Snowdrop). *Convallaria majalis* L. (Lily of the Valley). *Allium vineale* L. (Crow Garlic). *Allium ursinum* L. (Broad-leaved Garlic). *Narthecium ossifragum* Huds. (Bog Asphodel). *Arum maculatum* L. (Cuckoo pint). *Equisetum arvense* L., *Equisetum palustre* L. (Horse Tail), and *Pteris aquilina* L. (Bracken).

In concluding the list of British species it is necessary to refer to a grass, probably the only British species of the *Gramineæ* which is suspected to possess poisonous properties. Darnelgrass (*Lolium temulentum* L.) contains almost always in the seeds, immediately under the seed coat, masses of a fungus mycelium, which is said to have narcotic effects upon animals. *Lolium perenne* L. (Perennial Ryegrass), and *Lolium italicum* L. (Italian Ryegrass) on very rare occasions contain the same fungus. It is known that the darnelgrass seeds are

<sup>1</sup> A similar case has been brought quite recently to the writer's notice, where a valuable colt had died after eating the berries of our common Hedge Hawthorn. The seeds and stems had formed a large ball in the stomach of the animal, hard as concrete, which no medicine would remove.

poisonous to chickens and even cause death to the larger animals, when eaten in quantity. This may occur when the grass grows amongst cereal crops and the seeds are harvested with the grain. Thus, sometimes, horses are injured with signs of narcotic poisoning. The danger is very small from eating dandelion seeds, and, in my opinion, absolutely non-existent in the case of the other species of *Lolium*.

Farmers and stockbreeders have often referred to acorns as being poisonous to stock, but opinion on this point differs largely. Pigs and sheep eat acorns apparently without risk of injury, though a few cases of disease have been reported in these animals. Some observers record serious losses among young cattle. In small quantities mere accidental disorders may be produced, but when eaten in excess the true acorn poisoning symptoms are said to appear. The animals reject food of any kind; diarrhoea, free discharge of urine, discharge from the mouth, nostrils, and eyes have been observed, as if some irritant poison had been swallowed.

Other non-British plants, generally cultivated as ornamental shrubs or plants in gardens, have from time to time been responsible for the death of animals. So for instance *Nicotiana Tabacum* L. (the wild Tobacco Plant) and the varieties cultivated in gardens are poisonous to horses and cattle alike. Azalea, rhododendron, bay tree (*Laurus nobilis* L.), cherry laurel (*Prunus Laurocerasus* L.), poison oak (*Rhus Toxicodendron* L.) laburnum (*Cytisus Laburnum* L.), are highly poisonous plants, and stock should be prevented from getting at these plants. Hemp (*Cannabis sativa* L.) is a strong narcotic poison, but a few cases are known where in addition it showed the same properties as common flax, the fibres forming hard balls in the stomach and thus causing great pain and injury to the animals.

It is almost impossible to deal in a general way with the treatment of animals that have been poisoned with some vegetable substance. In the first place the nature of the poison is extremely varied, so that ignorance of the kind of poison taken makes it almost impossible to employ an antidote; moreover the action is in many cases so rapid, that if remedial measures are not taken immediately (which is most improbable) death results in almost every case of serious poisoning.

This regrettable helplessness only emphasises more strongly the necessity for a knowledge of poisonous plants and their properties, and of the symptoms in cases of poisoning. But, most clearly of all, it points to the prime importance of energetic and complete eradication of such plants from all places where cattle can obtain access to them.

If the poisonous plant be an annual, *i.e.*, reproducing itself by seeds only, it may be eradicated by preventing the formation of the seeds by cutting the plants just above earth, between flowering and seeding. Biennial, and perennial plants are much more difficult to combat. These plants should be dug up with their roots, where practicable, but when the plants grow in boggy places, in small streams or ditches, it is best to fence these portions off by a wire fence, so as to prevent the access of the cattle to these places. If the water of streams is to be used as drinking water for the animals, a new bed should be dug in form of a semi-circle and the other portions may then be fenced off. The new portions should be watched to prevent the poisonous plants getting a foothold in it.

To sum up the whole matter, owing to the well-known dangerous nature and rapid action of these vegetable poisons, and the great difficulty in applying appropriate remedies, the farmer should grudge no labour or expense in eradicating from his farm every plant that is injurious, feeling that it will repay him to have the knowledge that his stock runs no risk whatever of deadly and costly poisoning accidents.

H. T. GÜSSOW.

The Laboratory,  
44 Central Hill, Norwood.

---

## THE BREEDING AND FEEDING OF PIGS.

SUGGESTIONS have been made in certain quarters, arising probably from the higher prices ruling until the last two or three months, and also from the greater demand for home-grown products, that the breeding and feeding of pigs in Great Britain is becoming a declining industry. A study of the Returns of the Board of Agriculture, if carried over a sufficient period to allow of a judgment to be formed, by no means supports this conclusion. It is a matter of common knowledge that the stock of pigs often varies from year to year, but, if we look back over the last ten years, the figures do not show any very great variation from the average stock of a little under two-and-a-half millions in Great Britain. What change there is in the latest figures for 1907 is indeed in the right direction, for the 2,637,000 pigs shown in the returns made last June are above the average of the five preceding years, 1902-6, which gives only 2,519,000, and still more above average of 2,396,000, which was shown for 1897-1901.

If, therefore, this part of the farmer's business has not progressed in quantity to the extent that would appear to be the case in some other countries, such as Germany, it has at least held its own and a little more, in the face of the huge imports of pig meat received from Denmark and America. Moreover, since one of the largest bacon curing firms were able last year to discontinue the system of "docking" for overfat pigs, owing, as they stated in their circular, to the much improved class of pigs now bred in this country, I think we may take it that the above remarks would also hold good so far as the quality of the produce of the British pig is concerned.

The question that naturally arises is, could more pigs be kept in a general way, at a profit? Before answering this, a glance at the distribution of this two-and-a-half millions of pigs amongst the counties of England, Wales, and Scotland as set out in the tabulated Agricultural Returns for 1907,<sup>1</sup> will show a very extraordinary difference in the number kept in each county. Only two English counties returned as many as 100,000 pigs in 1906, but as many as seven passed that limit in 1907; and it may be convenient to show what has been the recent movement of pig stock of these seven counties in the last two years, compared with the average annual stock

<sup>1</sup> See County Tables, page 276 of this Journal.



kept in these areas in a five years period. Set out in this way the figures would stand somewhat as under :—

County	Single year, 1907	Single year, 1906	Average of five years, 1902-6
Suffolk . . . . .	158,101	140,918	155,448
Somerset . . . . .	128,266	115,933	124,382
Lincoln . . . . .	116,323	99,752	111,419
W. Riding, Yorks. . . . .	114,923	96,937	102,572
Norfolk . . . . .	104,664	92,593	105,000
Cornwall . . . . .	103,704	94,657	97,207
Devon . . . . .	101,054	90,989	101,329

This clearly shows that Suffolk heads the list with, for this year, as many as 158,101 swine. Indeed, there are more pigs in this county alone than in the whole of Scotland, where the total was 147,000 in 1907, and only 130,000 in 1906.

Suffolk not being a dairy county and not having a single bacon curing factory of any importance this seems somewhat strange. It will be interesting then to find out what facilities this county has that so many pigs are kept in it, as should the same conditions exist elsewhere, one is led to the conclusion that there is no reason why a much greater number of pigs should not be kept in the future than in the past.

Ipswich, the principal market town, receives considerable imports of maize and foreign grain, and as it is, unlike some ports, about twelve miles inland, a larger number of farmers are near enough to be able to take their feeding-stuffs direct from the vessels without warehouse or rail charges, which would not be the case if it were on the coast; thus curtailing the cost of these commodities. Being a wheat growing district a bountiful supply of wheat straw, an essential bedding for little pigs, is likewise always available in Suffolk, whilst in an arable county like this, the dung can always be profitably used to enrich the soil. Another probable reason is that it seems to be the fashion to keep pigs in this county, at any rate they appear to be held here in much higher esteem than in the neighbouring county of Norfolk.

To those farmers then who are in the possession of advantages in the way of food fodder and refuse removal, and who have also an inclination that way, pig keeping should, as a rule, prove a profitable undertaking, and the writer's own success in this direction allows him, perhaps, to offer the following notes and suggestions.

#### BREEDING OF PIGS.

Before giving any suggestions as to the most suitable pigs to breed, it is as well perhaps to remember that the subject has

F

to be approached mainly from two points, viz., that of the producers and that of the consumers, in other words from the farmers' and from the butchers' standpoint. It should be the object of the breeder to produce a saleable pig which will always command the top price in the market, and will also help the butcher or bacon curer to produce a commodity which will compare favourably both in price and quality with the vast amount of imported foreign goods which so readily find their way into the British market. At the same time the pig selected must also have the most important qualities of thriftiness and early maturity, which alone can make the business a profitable one to the feeder. In order, then, to be able to combine these qualities we must first consider what is the butcher or bacon curer's idea of what a pig should be. Anyone conversant with the pig market is aware that nearly all the pigs offered for sale are bought mainly by two classes of customers, either for the bacon curing trade, or by the wholesale pork butchers and provision merchants of the populous centres of the Midlands and North of England. The bacon curers require a pig of between 9 to 13 stone (14 lbs.) dead weight with a small proportion of back fat, deep in the flank, large hams, but small in the bone and fore quarters, and one which to all appearances looks like what is commonly called a half-finished pig.

The wholesale houses of the North and Midlands prefer for the most part a much fatter pig with a good back and flank, and weighing anything from 12 to 16 stone dead weight. A heavy head and shoulders as in the case of the bacon curers' pig is not desirable, but the animal should have a well-finished appearance.

So much, then, from the consumer's point of view, let us now turn to the producers. There are only about three weeks in a pig's life when it can be considered an ideal bacon pig, and as the curing trade is rather fickle, depending very much on the Irish supply of pigs, and also on the bacon trade, it is as well not to pay too much attention to this part of the market, but to try and produce such a pig as would be suitable for the curing trade, should this be good when the pig arrives at the proper size, and yet it should also have sufficient length, frame, and growth, to be profitable to feed on, for the heavier weights required for the North. The other main points to aim at are thriftiness and early maturity. Formerly, when corn was much dearer than it is now, pigs were allowed to run to grass for some months, and, in fact, they do now in Ireland, and some parts of this country. This certainly helped to produce lean bacon, but it also made them coarse and heavy of bone, and the practice has mostly died out in favour of early

maturity. In order to get this as well as thriftiness there is no doubt that a good first cross-bred pig will take a lot of beating, and there are few better crosses than that of a large white boar and a large black sow. The pigs come with plenty of length from the sire's side, and the requisite quality from the dam's, and they will mostly be all nearly white in colour, a feature which has been mentioned before as desirable.

Much has been written by previous and more able authors as to the care and management of breeding sows to which I must refer my readers; but from observations made by the writer himself he has come to the conclusion that nothing is so capable of success with sows as personal attention, and that nowhere are the results better than on the small holdings or with cottagers where the owner sees after the sow and her progeny himself.

#### FATTENING OF PIGS.

This question, like that of breeding, has two sides, the feeder's aim being to produce a given weight of pork at the lowest possible cost, whilst the consumer requires that pork to be firm, not oily, with a good proportion of lean meat. In deciding, therefore, what advice to give to feeders as to the selection of a suitable feeding meal, reference must be made to the state of the trade of feeding stuffs and offals. Maize, although much spoken against by butchers, seems likely to remain for its cheapness and fat-producing qualities the main food of the porcine race. This, however, should never be in a greater proportion than one-half, and then not in hot weather, one-third being much better, the other two-thirds being barley or wheat (when the price of that commodity allows it), and peas, lentils, or gram, according to state of the market. Some part of the ingredients should be home-grown corn, as this adds sweetness and digestibility to the meal. Millers' offals should be used for small pigs only, as they tend to make soft pork. Skim milk is supposed to improve the quality of pork, and is considered a very valuable article of food, but it is by no means a necessity, and in the author's opinion should never be given to little pigs whilst on the sow, and it is an open question whether its value for larger ones has not been overrated.

Fine meal is recommended as against whole corn feeding, as the animals can consume a larger quantity at a time, and therefore do quicker, although the ultimate cost per pound of pork has been proved to be about the same. Either meal or corn should be well soaked in good water before use, and pigs should also always have a good supply of clean water by

them, they should be kept well ringed and have dry beds to lie in, and occasionally a little vegetable in the shape of mangold or potatoes will help to keep them in health.

#### MARKETING OF PIGS.

When pigs are ready for the butcher they are disposed of in several ways, some are sent to the open market or auction sale of the nearest market town, or they are consigned direct from the farms to a Birmingham salesman or a bacon factory. There are several objections to both these courses. When sent to the local auction sale or open market the graziers are often the prey of dealers who form rings and knockouts when an opportunity offers, the consignor has no means of knowing beforehand whether there is likely to be a glut or a good demand for his goods, and he is often precluded from buying them in, or protecting himself in any way owing to the existence of local swine fever restrictions. Besides this there is the inevitable wear and tear caused by travelling about and delay between the time they leave the farm to the time they arrive at the slaughter-house. This wear and tear is more than most people would credit, and is much more in proportion after about two days fasting. Pigs are also much injured by being knocked about by the drovers, and by slipping on the greasy concrete of the floor of the pens. Beyond all this, when the pigs are sent to an auction sale they are sold with all latent defects, such as tuberculosis and oily fat; the vendors, therefore, of carefully fattened and healthy pigs have no advantage over the others, and cannot expect to get the real top price for their produce, as the butcher must make allowances for the losses he is likely to incur, and for which afterwards he can obtain little or no redress, as he would be able to do in the case of private consignments. This very fact must tend to send a larger proportion of questionable goods to the public sales than would otherwise be the case. The auction sales are not, however, without their advantages, and are no doubt of much assistance to the small grazier who is unable to sell more than three or four pigs at a time.

The alternative system whereby pigs are sent by the farmer to the bacon curers, Birmingham salesmen or Midland butchers, is, of course, a great improvement to the other method, and, at first sight, seems about as perfect a method as could be devised. When one, however, takes a wider idea of what true marketing is, *i.e.*, to supply the right article to meet the best demand at the time when the demand is greatest, it will be readily admitted that any agency that can make a study of the market and its requirements, keeping itself in touch with the various

branches of the trade all over England, regulating the supply when too heavy, hunting up and informing sellers when it proves too small for the consumptive demand, and selecting the right pigs for the right place, must be a great factor in promoting the profitable interchange of produce. The private seller must, of necessity, be without a great deal of this valuable knowledge, and he cannot hope by always sending to one or two customers to obtain the highest possible value for his produce.

#### CO-OPERATIVE PIG DEALING.

To establish an agency of this sort the Pigs Sub-Committee of the Eastern Counties' Farmers Co-operative Association was formed about three years ago, and the amount of its annual turnover and the confidence the members of the Association have placed in it, have quite justified its operations, and must be the excuse, if one is needed, for the short account of its methods included in this article.

The scheme was started in May 1905, and has shown steady progress ever since. The average weekly sales for that year numbered 106 pigs; in 1906, the weekly sales were 233 pigs, and for this last month I am informed the average would work out nearly 500 pigs per week. Pigs are sold for the members at either live or dead weight, the former being the most popular with the vendors, as they can see their own pigs weighed and then know exactly how large a cheque to expect; it is also gaining favour with the purchasers, as they need not kill the pigs at once on arrival, but can keep them over for a few days should it suit their convenience to do so.

The Committee referred to above consists of six members, all of whom are interested in and connected with either the breeding or feeding part of the business. They have at their disposal the services of a competent manager and his assistant. The manager who is quite a pig expert is known to and in touch with all the large bacon firms as well as the wholesale houses of the Midlands, he has the use of a motor car, and is on the telephone. The Committee meets weekly when the manager renders an account of last week's business, and states the number of the pigs he has on offer which constitutes the visible supply, he having been previously advised of these on printed post cards supplied by the Association or otherwise, while he also informs the Committee what orders he has from the Association's customers. Journeys are then arranged, it being a rule that no pigs shall be sent away in the name of the Eastern Counties' Farmers Co-operative Association without having first been seen and selected for each customer, as it has been found most desirable that a yard of pigs should be

carefully graded, and only those suitable for a particular customer's trade should be sent to that customer, and the farmer advised to retain only those pigs which are likely to put on further weight at a profit.

The Committee inquires into railway delays and other grievances of its members, and the weight it can bring to bear on the authorities concerned, in its corporate capacity, is naturally greater than that of a private individual. It is also able to further the course of business between the members themselves, the commission in these cases being shared between sender and purchaser.

The expenses are kept as low as is possible in a business of this sort, and when it is stated that the commission on the majority of the pigs passing through the hands of the Society amounts to 6d. per head, it will be readily admitted that the Committee's efforts in this direction have been very successful.

#### FUTURE PROSPECTS.

In forming an opinion as to whether pig breeding and feeding is likely to prove a profitable part of the business of the English farmer in the near future one must bear in mind that it takes roughly  $5\frac{1}{2}$  to 6 stone of corn to produce one stone of pork, it therefore follows that at the present prices of both foreign and English corn it is impossible to breed and feed pigs at a little under 6s. per stone, the price now current, and show any adequate return for the trouble and outlay. Should the corn trade continue firm, a better trade for pork must not be expected until farmers have reduced their stock by placing their pigs on an already overladen market, and have fatted and killed a part of their breeding sows. The trade which will have been going from bad to worse, will, I would venture to suggest, then take a sharp turn for the better, prices will rise as the supply of bacon runs out, and once again we shall look on the pig as the gentleman who pays the rent.

In conclusion, I beg to tender my best thanks to the members of the Pigs Committee of the Eastern Counties' Farmers Co-operative Association and their manager, Mr. Maurice Wright, for the help they have kindly given me in the preparation of these notes.

W. WILSON.

Baylham Hall, Ipswich.

---

## PIGS AND BACON.

I COULD not better commence this article than by stating, and I do so with very much pleasure, that the general quality of the English pig has never been better than it is to-day, and that from the bacon curer's point of view the character and breed now predominating show a marked improvement when compared with those of twenty years ago. It is not an easy matter to forecast the future prospects of the feeder and the curer; indeed, it is not possible for me to do so very closely, but I trust the information I am able to give on the various phases of the subject will assist others to form rather more accurate opinions for themselves than they otherwise would do. That the interests of the feeder and curer are indissolubly bound up together needs no emphasis from me, but I think I may fairly state that a greater mutual understanding exists between the two than was the case years ago, which is, of course, a desirable state of things, and one which characterises the position of our foreign rivals. I will first refer to the

### BREED.

Exceptionally good results have attended the strenuous efforts made during the past twenty years to improve the breed of the British hog, or rather, to so change the breed as to produce the class of meat that will yield the best return; which of course means yielding the meat demanded by the bacon curers, who are in turn governed by the requirements of the consuming public. Amongst the efforts referred to it may be stated that some years ago my own firm expended large sums of money in the gratuitous circulation of hundreds of pedigree boars throughout the West and South of England, whilst concurrently the Irish bacon curers were exerting themselves in similar fashion in their territory; and it is only a year or so ago that a similar scheme was carried through in Cornwall, one of the largest pig-producing counties—by a combination on the part of all the leading bacon curers of the West of England. The class of boar mainly supplied was the Large White Yorkshire which, crossed with Berkshire sows, is considered best adapted for production of the present-day bacon hog. Needless to add, we confined our purchases to the noted breeders. And now as regards the results: Fifty years ago it was the rule rather than the exception to kill pigs for bacon at ten to fourteen score, or even heavier, but the public taste gradually veered round to the other extreme during the eighties and early nineties until, in 1893, the bacon curers

became so embarrassed by a demand for lean bacon, out of all proportion to the supplies of lean pigs obtainable from the farmers, that it became inevitable that some drastic change should be made in the methods of purchase. It was felt that *thickness of fat* as well as *weight* would have to govern the value, and after much anxious thought a "scale" or "dock" was introduced whereby, to secure the best prices, carcasses had not only to come between certain desirable weights, but in addition might not exceed two-and-a-quarter inches of thickness of fat in any part of the back. Well, such a revolution, introduced as it was with a convincing determination that it had come to stay, undoubtedly caused feeders to study more closely what foods were fat-producing, what were not, and how they could best secure the highest market prices. Many experiments were made both privately and by public bodies such as the County Councils, and probably one of the most useful series took place in my own county of Wiltshire, where upwards of forty diets were tried under uniform conditions by a representative committee, over which I had the privilege to preside. But it was also during this time that the pedigree boars were being distributed, together with a profusion of literature urging breeders to confine themselves to those pigs alone whose progeny might be depended upon to find a ready market. Satisfactory results were not long in asserting themselves. Only a year or two passed before the percentage of lean pigs began to increase, and roughly speaking it may be hazarded that by the year 1900 a point had been reached where, at all events in the case of the West of England pigs, the proportion of lean to fat pigs emanating from feeders generally was all that could be desired and all that was required by curers to meet the demands of their customers. Since the date just mentioned this satisfactory state of things has continued, and now I come to the point which demonstrates not only the wisdom of the 1893 action but shows how important a factor the breed is—as distinct from the feed—in the hog-raising industry. The "scale" (or "dock" as it was more generally termed) was always recognised alike by farmer and curer to be a necessary evil and expedient, and undoubtedly in many cases apparent hardships arose which mitigated against the supply; so it may be imagined that universal satisfaction was felt in February last when the curers came to the conclusion that so marked an improvement had taken place in the whole character and breed of the present day pig, as compared with its ancestors, that they were justified in removing the whole of the restrictions which for fifteen years had been imposed upon the thickness of fat. In other words, the pig of the future was to be paid for entirely by



weight, reverting broadly speaking to the conditions obtaining prior to 1893, curers relying that having revolutionised the strain of breed as well as the feeders' ideas as to what was good and what was bad feeding-stuff, they would continue to find pigs yield a sufficient proportion of lean to fat to meet their needs. Thus it will be seen that the question of breed has played an important part in deciding the methods upon which business is to be carried on between feeder and curer.

Whilst on the subject of breed I ought to emphasise that one of the parents should always be pedigree and that pigs from Berkshire sows by large Yorkshire boars are pre-eminently suited to the requirements of the bacon curer. Pigs bred in this way can easily be made eight score in weight by the time they are six to seven months old. The



accompanying photo, taken a little while ago, shows two such pigs on my own farm, bred by myself. These pigs were killed when six months and ten days old, and averaged 8 score 2 lbs. dressed weight. I should also mention the significant fact that the best breeds of pigs predominant in England are universally recognised as the best breeds in the world, as is proved by the fact that all foreign countries come to England for their pedigree boars and hilt, of which very large numbers are exported by breeders every year.

I will now turn to the equally important question of

#### FEEDING MATERIALS,

and whatever secondary articles are used I trust that by this time every one is convinced that barley meal is the one and only food to form the basis of the pig's diet. The best

subsidiary foods are undoubtedly potatoes and milk, though bran with barley meal has in many cases been found to yield exceedingly good results. It is perhaps unnecessary to say that the dairy farmer possesses a great advantage in the *profitable* production of bacon hogs, but to the very many feeders who are without this advantage I would say that, with care, they may safely supplement their barley meal with pea or bean meal as well as bran. West of England bacon owes a great deal of its supremacy to the fact that dairy bi-products have been so largely utilised for feeding purposes together with the best meal obtainable, and to the very limited use of maize meal by all feeders anxious to produce the highest class pigs. Those fed on maize may be depended upon to yield soft and bad quality meat; they are more susceptible to disease, whilst—though a minor point—their bones are much more brittle, with the result that in transit they sustain greater damage in the way of broken legs, &c.

This brings me to the question of

#### RAILWAY SERVICE.

This is a subject of vital importance to the pig and bacon industry. Not only is the cost of removing live and dead stock from one point to another very oppressive, but on the contrary we find our foreign competitor enjoying railway and shipping rates such as materially assist him in his efforts to oust us from our own market. It is scarcely credible that it costs West of England curers more to deliver bacon in Edinburgh or Glasgow than it does the Chicago packer to deliver in London, entailing though it does a thousand miles of rail in the States, three thousand miles on the water, and then the distance from Liverpool or Southampton to London. Or take the case of Denmark. The Danish State Railway delivers bacon from 200 miles inland to the port of shipment at the rate of 10s. per ton, as against its costing my company the same amount to deliver to Bath (18 miles). Again the rate from New York to Cape Town is 15s. per ton, whilst from Southampton (700 miles less) it is 31s. 3d., and so on. Needless to add, equally wide differences exist in the case of the carriage of live stock; and it is too obvious to need much emphasising that this is proving a serious handicap to the home producer, for not only is the curer's trade restricted, which reflects on the farmer because less pigs are required, but having to pay these heavy transit charges on the business he is doing, the curer has to pay correspondingly less for his raw material.

#### THE STATE OF THINGS ABROAD.

If, as has been argued, foreign supplies of hog products affect the home market so considerably, is it not desirable that

we should more closely investigate the foreigner's methods to see whether they are superior to ours, and if so to consider the expediency of adopting them? I fear there is often a tendency in England to despise rather than to take seriously our foreign rivals, but I must admit that so far as my own investigations have proved we have a great deal to learn. In the United States, Canada, Denmark, and various other countries, State-aided Agricultural Colleges exist purely with the object of assisting the agricultural industry, in the first place by scientific research, and secondly by inculcation of knowledge. Contrary to this, we in England have had in the past to rely on private enterprise to a large extent. I have before me now an exhaustive report on "The Production of Bacon for the British Market," recently compiled by a special Live Stock Commissioner of the Canadian Government, who in a forty-six-page book includes the very greatest detail both of fact and figure, and also a score of photographs of hogs, sides of bacon, &c., invaluable to the Canadian. In Australia and New Zealand, too, we have only recently heard of increased activity in the development of hog-raising as an adjunct to the dairy business, whilst in European countries generally the pig continues to receive a very large share of attention. Nowhere is this so marked as in Denmark, a country that thirty years ago had no apparent aspirations to the prominent position in the bacon world which she occupies to-day. At that time she was mainly concerned with raising supplies of pork for Germany, where she eventually established such a business that, in the interests of the Teutonic home producers, a heavy tax was imposed on all Danish supplies.

The Danes therefore received a temporary check, but with a characteristic tenacity this only spurred them on to greater accomplishments, and serious attention was then turned to the British market. They were a poor nation; they had to a large extent a notoriously bad soil, but they conceived—and events have justified their conception—that, by judiciously developing the dairy and hog-raising industries side by side in such manner as to secure help, and not hindrance, one from the other, they had the opportunity to establish a trade which would be remunerative to the individual and at the same time advantageous to their country. That they have succeeded beyond their expectations cannot be doubted, mainly of course on account of their free access to the English market. And if we turn to Canada we find the same inter-dependent state of affairs existing between the dairy and the pig-sty, to the unquestionable advantage of both.

Unfortunately, I have to complain of the methods adopted in selling this foreign bacon here in England. To so butcher

and manufacture their meat as to resemble our own is one thing, and even to use such terms as "Wiltshire," "Stafford," and "Cumberland" in their factories for the purpose of distinguishing the various cuts, but these appellations should certainly not be continued when the meat reaches this country if, as is the case, by so doing the British public is deceived into believing that such goods are of home manufacture. Our "Merchandise Marks Act," if more rigorously applied would, of course, absolutely prohibit the importation of goods so labelled, but so far as the bacon trade is concerned this Act might almost as well not exist.

One other important point in connection with foreign supplies must also be mentioned, viz., the use made of borax. The presence of this and kindred chemicals are not considered desirable in foods of any kind; indeed, there is a consensus of opinion that borax is distinctly injurious to human health, and this finds support amongst the medical profession to a very large extent. On the other hand, the bacon manufactured in England is, I believe, invariably cured without the use of this objectionable article, salt and saltpetre alone being employed to preserve the meat.

The importation of foreign bacon under present conditions is therefore doubly unfair since, in the first place, this meat is not distinguished by any mark whatever from the home article; and in the second place it contains borax without bearing any mark to show that such is the case. And this disadvantage to the home producer is accentuated when it is pointed out that this boraxed bacon is inclined to appeal to the palate for the reason that correspondingly less salt is necessary to preserve it. My argument is, that without in the slightest degree restricting the importation of foreign bacon, the source of origin should be plainly marked on every piece; and in view of the present state of public opinion there should be added some indication as to whether or not it is "guaranteed free from borax."

Here, again, we can learn from the foreigner's methods. Practically every foreign government not only insists on a sworn declaration as to the country of origin and the conditions under which the pigs have been bred, fed, and killed, but they absolutely prohibit the importation of an ounce either of bacon or other produce that has come into the slightest contact with borax in any shape or form. And their Custom Regulations are by no means confined to these limits. At the present time we have, in addition to complying with the aforementioned requirements, to supply a veterinary certificate, signed by a duly authorised Meat Inspector, declaring that he has personally subjected the hogs to ante-mortem as well as post-mortem

examination in the case of all bacon sent into the United States of America; and other governments are getting equally particular. To advert for a moment to the question of *unfair* foreign competition, I would like to quote from Mr. Birch-enough's Report on his "Commercial Mission to South Africa," which epitomises a pressing grievance that is even more acutely felt to-day than when written in 1903:—

"By far the greater part of the bacon and hams imported into South Africa come from Great Britain. A certain proportion is of British and Irish origin, especially in the better qualities. The general practice, however, is for British firms to bring over what may be called their raw material in brine from the United States, Canada, and elsewhere. It is then cured or '*finished off*' in England, packed in salt, slipped in canvas, and despatched to its destination" (as *British Produce*).

I trust I have said sufficient to sustain my point that there is room in England for improvement in controlling the foreign supplies, and that a study of our competitors' methods gives us food for serious thought.

And now to come to the

#### POSITION AND PROSPECTS.

Taken on the whole, the prospects appear to me to be anything but unfavourable if viewed from a broad standpoint, though in the immediate future the industry will undoubtedly be curtailed as the result of the abnormal prices which have lately ruled, and continue to rule, for feeding materials. So far as pigs are concerned the farmers always have a ready market right at their door. I cannot answer for all, but so far as my own firms<sup>1</sup> are concerned, we are open to give best market prices for all the prime quality pigs we can get every day in the year. Under present conditions our markets are certainly at the mercy of the foreigner, whose fluctuation of supplies largely affects the home prices.

Much depends, upon the methods pursued by the farmers. If, as in so many cases hitherto, they are content to follow the course of their ancestors, oblivious of the evolution that has been going on around them, no legislative efforts will achieve the desired end, and from a close knowledge of the farming fraternity, particularly those who handle pigs, I am constrained to say that there has always been a tendency to magnify disadvantages and to correspondingly minimise advantages accruing from the various branches of their business.

<sup>1</sup> Messrs. Chas. & Thos. Harris & Co., Ltd., Calne, Wilts, and the West of England Bacon Co., Ltd., Redruth, Cornwall.

There is not that thorough system of book-keeping begin with, which in all other trades is a *sine qua non*, and are the various processes kept such close track of as is the very life-blood of our manufacturing industries; hence the same degree of economy cannot be secured. Again, there is not that readiness which characterises other trades avail themselves of the latest forms of machinery and labour-saving appliances.

There are notable exceptions. Here and there is to be found a farmer pursuing a very enlightened course, and such a farmer is invariably reaping the benefit of his enterprise. So far as the pig-producing industry is concerned the Eastern Counties stand out conspicuously. Their methods differ materially from those adopted in other parts of the county alike in their buildings, means of breeding, and feeding. Very active co-operation exists both for the purchase of small piglets and food stuffs and in the sale of the fat stock, notably in the case of the Eastern Counties Farmers' Association.

Personally, I cannot help thinking that sooner or later the co-operation will spread; I am equally convinced that in the not distant future the agricultural position will not be quite so acutely exposed to the attacks of the foreigner. Indirectly the growing sentiment in favour of "supporting home industries" should help us. The improvement in breed and general quality which I trust I have proved beyond doubt, is a distinct advantage, and altogether I feel justified in forecasting very favourable prospects for the future trade of the pig, whose contribution to the world's food supply occupy so important a place.

JOHN M. HARRIS.

Messrs. C. & T. Harris & Co., Ltd.,  
Calne, Wilts.

---

## MANGOLDS RUNNING TO SEED.

ONE of the most curious features about the crops of the past season was the large proportion of mangold plants which "bolted" or ran to seed prematurely. This was reported from all parts of the country, but appears to have been worst in the north, where in many cases the majority of the plants ran away, until the fields seemed to be carrying a quite unfamiliar crop. Nor was the bolting confined to mangolds; to a less degree it was seen in all biennial crops—in carrots, swedes, cabbages, even in Brussels sprouts and broccoli in the gardens. There was little in the character of the season which would have led one to expect such a result; there was no sudden heat or drought, nor any check to growth such as would bring about a premature ripening followed by a renewal of activity. On the contrary, the whole early summer weather was remarkably uniform, being of a persistent westerly type; though temperatures were generally low this was more due to lack of sun and warmth during the day than to cold nights; the actual rainfall was never heavy, but the number of rainy days was above the average. September was the only dry and warm month in the year, but the mischief had been done long before September; the mangolds at Rothamsted began to run up in July, the bolted heads were all cut off in early August, and though they shot up again not many fresh plants had bolted when the crop was lifted in November.

On the Barn Field at Rothamsted, which has now been growing mangolds for the last thirty-two years, counts have been made from time to time of the proportion of mangolds running to seed on the different plots, whenever any large number was to be seen. Curiously enough in 1907 there was very little difference in this respect between plot and plot; whatever the manuring, whether light or heavy, good or bad for the yield, much the same proportion of roots had run to seed; perhaps rather more on the plots receiving rape cake as a source of nitrogen than on the others. But in more ordinary seasons the greatest proportion of bolters are always to be found on the plots manured with ordinary farmyard dung, irrespective of whether any artificial manures are also supplied. On the plots manured with artificials only no difference can be found between the effects of sulphate of ammonia and

nitrate of soda, but, as noted above, rape cake sometimes results in a greater proportion of bolters.

It seems, however, to make little difference whether the plant has much or little nitrogen, or whether potash or phosphoric acid is added or omitted; in fact, it is not the nature or amount of plant food that makes the difference but the action of the manures upon the tilth and texture of the soil. On the Barn Field in question the soil is a stiff stony loam which has fallen into a poor mechanical condition where it has been farmed with artificials only for the last fifty years; it is difficult to get a nice seed bed, and in some seasons a very imperfect plant is obtained in consequence. But where farmyard manure is applied every year, and to a less degree where rape cake is used, the constant addition of organic matter has kept the land in good tilth, so that in most years the mangolds start more quickly and grow away more evenly and rapidly on the dunged plots than on those dressed only with artificials. There being more humus in the soil, the young plants suffer less from drought and are not checked so much if a dry time comes while they are still small.

Thus we see that the largest proportion of bolters occurs on the plots on which growth is most free and uninterrupted; we may also add that early sowing seems to conduce to bolting.<sup>1</sup> Now these results on the whole agree with what has been seen everywhere this season; excessive bolting has accompanied an early start of the mangold seed and unchecked growth during the early stages. It was the general experience this year that even when mangold seeding was thrown late by the weather germination was not long delayed, and the repeated small rains kept the plant moving from the very first. Why this should conduce to bolting cannot be explained; it is interesting, however, to find from the Rothamsted results that the season is only responsible and that the character of the manuring will make no difference, for of course under ordinary conditions of farming the exaggerated differences in tilth between the plots receiving farmyard manure and those dressed with artificials only will never occur.

The question is sometimes asked as to the food value of mangolds that have run up to seed; of course their chief drawback is the hard woody character they assume, but the following analyses made this season by Dr. N. H. J. Miller, at Rothamsted, may be of interest:—

<sup>1</sup> On this point Sir John Thorold has supplied me with some interesting evidence. He writes: "I sowed Vilmorin's half sugar beet on the 27th April. One plot was destroyed. . . . I re-sowed it on the 24th June, hardly any of it ran to seed whilst the remainder ran very badly both in the garden and on the farm."



	Average weight	Percentages in root as pulled				
		Dry matter	Reducing sugar	Cane sugar	Nitrogen	Ash
Ordinary roots . . .	Lb. 3.78	12.24	0.214	8.06	0.104	0.853
Seed roots . . .	3.87	12.23	0.353	7.05	0.090	0.935

The roots were of about the same average weight and contained the same proportion of water and dry matter, but in the roots run to seed less of the dry matter consisted of the really valuable constituent—the sugar, the difference amounting to one-eighth of the whole. The seed roots contained rather more reducing sugar and less nitrogen, and this marks the fact that the formation of top is accompanied by the conversion of cane into reducing sugar, which together with soluble nitrogen compounds is moved out of the root to form the seed head. Putting aside their indigestible fibrous nature, the seed roots thus contain less food than those which have not bolted.

A. D. HALL.

Rothamsted Experimental Station,  
Harpenden.

## AMERICAN MEAT EXPORTS. •

THE growing volume of the imports of meat into the United Kingdom, and the predominance which the United States still holds in our markets as a purveyor of live animals, dead meat, and meat products, justifies attention being directed in this Journal to the very elaborate inquiry recently concluded by Mr. Holmes, the chief of the Division of "Foreign Markets" in the United States Department of Agriculture. In this report he publishes his conclusions as to the meat production, meat consumption, and export surplus of his own country. Great changes have been effected in the dimensions and the origin of our oversea meat imports since this question was the subject of detailed dissection in these columns twenty years ago. The Board of Agriculture assure us there is no evidence of any diminution in our home supplies of meat. Nevertheless they do not expand, as do the numbers of our consumers, and a larger meat ration is only secured to us by the growth of imports. The Agricultural Returns of 1906 indeed makes it plain that we receive fully twice as much dead meat per head

of the population, 47 lb., as against 23 lb., as we did in 1886-90. Now although the American quota is somewhat diminishing in the last few years, it is still much the greatest source of the aggregate foreign and colonial supply, which considerably exceeds 900,000 tons per annum, while the States are also sending us five-sevenths of the cattle and more than four-fifths of the sheep which reach us alive. It cannot therefore be otherwise than a matter of the keenest interest to watch what are the prospects of American meat exports.

It would require an examination far more detailed than could be entered on in the scope of a passing note, to analyse and explain the methods of Mr. Holmes' new investigation. That it would repay such attention is obvious by a glance at the sixty-one tables of this little volume of elaborate statistics, but two things stand out clearly of which it is well to take serious note. First of all the vast growth of the American population—as was forecasted twenty years ago in these columns—is pressing more closely on its stock of meat animals; and the growing volume of these exports has not got behind it an equivalent expansion of the herds from which it is drawn. If Mr. Holmes is right we are to understand that out of an annual slaughter of 93,500,000 animals (cattle, sheep and swine) yielding upwards of 19,000,000,000 pounds of meat (dressed weight and extra edible parts), seven-eighths of the whole is now required at home for the sustenance of the 84,000,000 inhabitants of the States, and only one-eighth is available for export to the rest of the world. That eighth, however, is of goodly dimensions, for it exceeds considerably 2,000,000,000 lb. or in round numbers over one million tons, while besides this there is spared a net export reckoned in this report at 276,000 live animals.

By another method of computation Mr. Holmes translates the weight of dead meat exported, after satisfying the wants of his own people, into the equivalent it would represent were an actual exodus to occur in live animals of each class. Adding this hypothetical figure to the total of the live trade he tells us the States send abroad a net export equal to 1,321,000 cattle, 11,000 sheep and 8,659,000 swine or very nearly ten million animals "live or computed" in the space of a single twelve months. The proportion these great totals represent to the whole stock of potential meat producers in the States was greater in 1900 than it was in 1890—or some 12·68 per cent. as against 8 per cent. only—but we are led to conclude that this increasing export is not likely to be maintained in any further accelerating volume, since the estimates here offered of the domestic consumption suggest that the augmented outflow has been effected by a reduction of the rate of consumption at home. Whether

this is a correct deduction from the figures could only be decided by a critical examination into the alternative that may be hazarded as to a larger and quicker outturn from a like stock of animals at the later date as farming methods improve. This cannot be attempted here, but accepting Mr. Holmes' estimates it would seem that, per head of their own people, the United States have less and not more animal wealth to dispose of. By a series of very ingenious calculations this official report succeeds in constructing a theoretical "composite animal" into which is merged for convenient statistical comparison the varying numbers of cattle, sheep, and swine; and on this basis it is alleged that whereas in 1840 every 1,000 persons would have had 1,043 such "animals" to depend on, the ratio had dropped to 860 in 1860, and to 838 in 1880. After an apparently abnormal recovery to 900 animals in 1890, there remained, at the close of the century, only 700 of such composite units of meat supply available to every thousand of the American people.

---

## WOOL PRODUCTION.

AMONG the official publications of the year a special interest attaches to the report embodying the conclusions of the Board of Agriculture on the results of their investigation of wool production in 1905 and 1906. Numerous estimates of the total clip of wool in this country have of course been made. The suggestions made in the earlier individual inquiries in 1800, in 1845, and in 1858 differed very widely, and they had no such basis of fact as has been available since the numbers of our flocks began to be recorded forty years ago. Mr. Archibald Hamilton's figures in the *Royal Statistical Journal* of 1870, were the first relying on the new returns, and the older readers of this Journal will remember the article which appeared in 1875, in which Earl Cathcart offered another calculation, founded also on Messrs. Hubbards' tables, and resting on the basis of the official enumerations of sheep in 1867-69. This gave an estimate of the varying local weights of wool clipped in different counties. The total then suggested left out of account, apparently, the quantities of fleeces from slaughtered sheep and from lambs, and was no more than 124,000,000 lb., against Mr. Hamilton's earlier estimate of practically 160,000,000 lb., while Mr. John Algernon Clarke, writing also in this Journal only three years later, and employing as his starting point the flocks of 1875, followed the same method with the still lower result of 119,473,000 lb. Sir James Caird in the same year as Mr. Clarke

raised his total to 136,000,000 lb., while in the decade from 1873 to 1882 inclusive, the often quoted figures of the journal which then bore the name of the *Bradford Observer* gave a fluctuating total ranging from 167,000,000 lb. to 129,000,000 lb. In the face of these divergent estimates of authorities it was high time we had some closer official inquiry, and the methods and results of this are explained in Mr. Rew's report, dated August last, and above referred to. The reason for including the fleeces of slaughtered sheep and of lambs, not only slaughtered but in some counties shorn, are here explained, and an aggregate of over 133,000,000 lb. is ultimately arrived at, made of the following separate items:—

	Lb.
Sheep shorn in Great Britain (average of 1905-6) ...	87,838,000
Sheep slaughtered in Great Britain (average of 1905-6)...	30,250,000
Lambs shorn in Great Britain (average of 1905-6) ...	2,000,000
Lambs slaughtered in Great Britain (average of 1905-6)	1,000,000
<hr/>	
Total for Great Britain ... ..	121,088,000
Add separate estimate supplied for Ireland	12,000,000
<hr/>	
Total for United Kingdom ... ..	133,088,000

This total is of course admitted to be approximate only, but it is interesting to note that it but little exceeds the figure hitherto quoted on the journalistic authority of the great Yorkshire centre of the wool trade. The latest report will, however, repay the closest study, for it is based upon a very searching local inquiry, carried out not only by the agricultural correspondents of the Board and its market reporters throughout the country, but by direct circulars and requests for information supplied in 1905 from over a thousand flockmasters and wool growers and representative agriculturists, and from nearly as many in the subsequent year—in both instances supplemented by information contributed by wool buyers in the typical centres of Great Britain. In the space here at command it is not feasible to reproduce the county and breed tables of average weights of fleeces, widely varying as they might be expected to do. The reader who wishes to learn what the clip of the great leading breeds is put at locally by the very practical observers here employed, should not fail to examine for himself the local notes on these points which are so fully reproduced, largely in the words of the writers who favoured the Board with their views. Although disclaiming to supply an exhaustive catalogue of the breeds of sheep and of their local distribution, the report goes far to furnish materials of the first interest to the flockmasters of Great Britain respecting twenty-nine separate breeds for which estimates of production have been supplied. It is significant in this connection to find the

Blackfaced and Cheviot sheep the most widely distributed of all in Great Britain. The Border Leicesters appear to prevail next most widely, while Hampshire, Shropshire, Oxford Downs, Southdowns, and Lincolns may be noted as prominently widespread in the English counties. Mr. Rew's report presents many interesting comments on the opinions held respecting the wool trade of the country and reflects the variety of views held by practical men on the practice of washing wool. Considerable attention will undoubtedly be given to this report, and its lessons at a time when, after long discouragement, the hearts of flockmasters have been revived by the recovery of wool prices in these recent years, which broadly speaking has carried the average values of this once prominent item of British agricultural produce upwards since 1902 by little if at all short of 100 per cent.

---

## PLEASURE FARMING.

THE question of "What is a farmer?" has often been put and variously answered in agricultural discussions. A year ago, in this Journal,<sup>1</sup> it was pointed out that the term is by no means identical with "occupier of land." Dealing with England alone, it was then noticed that less than 189,000 persons returned themselves to the Census of 1901 as falling under the category of "farmers and graziers"—while the Agricultural Returns showed that just about twice as many persons were in some capacity occupying land in that area. If the census figures for the larger unit of England and Wales were, as is more usually the case, referred to, we should still find only 224,000 persons calling themselves "farmers" while 443,000 agricultural holdings find a place in the yearly statistics. Even bringing Scotland also into purview would only carry the self-classified "farmers" to 270,000 all told in Great Britain, while the "occupiers" were well over half-a-million. Many explanations of this phenomenon—which is obvious also, in many other countries than our own—have been forthcoming, and they need not be repeated here. It is sufficient to remember that the "occupation" inserted in the Census Schedules is only that which comes first, either by accident or design in the householder's own return, and he may be, and often is, engaged in many other capacities. Smaller holders, in particular in England, like the crofters in Scotland, will be often occupiers but not primarily farmers; and it is a well

<sup>1</sup> Volume 67, 1906, page 9.

recognised fact, although one not to be exaggerated in importance, that a good many persons who fill up their agricultural returns every June are holding land only as an incident of their residence. Until we can get some reasonable amendment of our census classification—such as Germany, for example, possesses—we shall not know with any precision what are the various businesses other than agricultural which our land occupiers pursue. But till that day arrives, a minor degree of interest attaches to the somewhat unusual investigation the Board of Agriculture has embarked on last year in asking the occupiers of Great Britain, by way of postscript to their statement of crops and stock, to indicate the cases where their farming operations were carried on for other than business purposes. It may be confessed that the occupier confronted with this query may often have had some difficulty in logically deciding where farming for profit, and the receipt of income however small, ceased, and where amateur farming or the use of land for pleasure or residential amenity began. But partial as this inquiry is, it is not without interest to learn from the Agricultural Returns for 1907, that 5½ per cent. of the holdings over an acre recorded in Great Britain were not, in the opinion of their occupiers, “farmed for business.” Of the 28,403 persons out of 510,954 so classifying themselves as amateurs in agriculture, 24,224 are met with in England alone. Only about 2 per cent. of the holdings in Scotland are shown here as pleasure farms. Were the acreage rather than the number shown, the small area thus occupied would be more evident. Holdings of over fifty acres are accounted for as pleasure farms only in comparatively rare instances—although there are apparently 2,635 such farms shown in the returns. Non-business holdings are much more numerous in the smaller grades, and, as would be expected, the Home Counties generally are most prominent in “pleasure farming.” One-fourth of the Surrey occupiers and one-fifth of those of Middlesex are of this type, while half of the very small number of agricultural holdings lying actually within the County of London are so classed.

---

## CO-OPERATION AND AGRICULTURAL CREDIT.

AMONG the distinctive movements of a practical and non-political character which have distinguished the past agricultural year must be placed the further development of the practice of co-operation in England. Not only are new local societies gradually coming into being, but the lesson of organisation

among farmers—and those not of the smallest grade only—is certainly, if slowly, spreading; and the example of our neighbours on the Continent of Europe, especially in Denmark, in France, in Germany, and even in Italy is proving a stimulus to this particular form of self-help. What isolated agriculturists cannot possibly do, in the way of securing the best terms for purchase and the best market openings for sale, a group of associated persons may. How in a comparatively short time producers can succeed in finding markets is well illustrated in connection with the local pig trade of East Anglia, quoted elsewhere in the columns of this journal. Moreover it seems clear whatever else may come of the renewed endeavour to multiply small holdings in England, that experience is tending to confirm Lord Onslow's committee in their view of the important part co-operation and co-operative credit systems may be called upon to play in the effort. Without such aid the planting about of small isolated farmers to take their chance in the struggle which bigger men have found so hard—to buy cheaply on the one hand and to sell their produce satisfactorily on the other—is not a very hopeful prospect. The convenience also and economy of employing Co-operative Allotment and Small Holdings Societies as tenants for areas to be converted into small holdings is now made evident. The problem of cheaper transport, too, cannot be effectively tackled without the combination and loyal co-operation of producers, either large or small. The many sided nature of the newly started societies, however, strikes one forcibly on reading the analysis of local institutions started under the auspices of the Agricultural Organization Society in quite recent years. Co-operation seems applied not only, as in two-thirds of the affiliated societies, to the supply of agricultural requirements and the sale of produce, but to exceptional bodies dealing with dairy produce, fruit grading, special rural industries, conveyance of produce, and motor service. More especially attention may be called to the development of Agricultural Co-operative Credit Societies, such as those described in the evidence and report of the recent Departmental Committee on Small Holdings, where the typical success of the Scawby Credit Society in a Lincolnshire village was so clearly shown by Mr. Sutton-Nelthorpe. To the suggestion made in that evidence as to the useful part which might be played by a central co-operative bank in financing a network of small local societies, formed on the lines of these schemes, effect has been given by the registration of the Central Co-operative Agricultural Bank, with Mr. R. A. Yerburgh as chairman of the directors. That this movement is capable, if wisely directed, to meet a very well recognised local want is probable; but those who wish to

study further the distinctive features of sound local credit institutions may need to be reminded that co-operation is a plant of somewhat tender growth. It behoves all our reformers to weigh well the principles on which alone by successful appeals to local self-interest, the striking development of agricultural credit associations has been secured on the Continent in the past half century. In this connection a large mass of digested experience, already acquired in foreign practice, is available in Mr. Wolff's new work on "Co-operative Banking,"<sup>1</sup> and those chapters on the local work of the societies to which the name of Raiffesin has been applied, and on co-operative mortgage credit, deserve close attention. Promoters of the newer movements here will of course have to decide for themselves how far the methods which have secured unqualified success in many other States may be adaptable to our native conditions at home, as this does not always follow. But this book offers a timely review of certain aspects of the question, and notes not only the encouragement to be gained but emphatically exhibits the dangers which may attend those efforts where too much reliance is placed on nursing new societies from outside sources, governmental, municipal or otherwise, and where too little reliance is placed on the healthy sentiment of direct local interest and local self-help, without which the motive power wanted for ultimate success of a genuine credit system, resting on the close association of borrowers and depositors, is too often lacking.

---

### SIR MASSEY LOPES.

By the death, in his ninetieth year, of the Right Honourable Sir Massey Lopes, the agriculturists of Great Britain have lost a warm friend and an able champion; and the Royal Agricultural Society will not soon forget the services which in his long and active life he rendered to its work. His membership of the Society, which began sixty years ago, has covered the whole period of the changes, developments, and depression which have successively characterised the history of British agriculture from 1848 to the present time. Sir Massey Lopes first served on the Council in 1865, and reached the chair some twenty years thereafter, being President of the Society in 1884-5 at the Preston meeting. Succeeding in early life to large estates in Devon, he effected many notable agricultural improvements, depending, as he told a recent Royal Commission, very largely in the course of forty years on the development of his land and the improvement of the position of his tenantry.

<sup>1</sup> *Co-operative Banking, its Principles and Practice.* By Henry W. Wolff. London: P. S. King & Son.



It has been more particularly, however, in public life that his most notable services to the agricultural interest of his country have been rendered. Entering Parliament as member for Westbury more than fifty years ago, he held his seat for that borough from 1857 to 1868, and sat thereafter for South Devon from 1868 to 1885, when he quitted Parliamentary life. A memorable speech on the incidence of local taxation which he delivered in 1868 recalled to the attention of the House of Commons the peculiar grievances suffered by ratepayers in the undue and disproportionate share real property was called upon to bear in the burden of the local rates. From that date up to 1874, when a measure of relief was secured by grants of imperial subventions for purposes of national concern charged on real property, Sir Massey Lopes was the acknowledged leader and spokesman of the agriculturists in Parliament, forming the organisation known as the Local Taxation Committee in 1869, of which he was the earliest chairman, playing a large part in the Parliamentary inquiries and debates on rating questions in 1870 and 1871, and presiding over the Central Chamber of Agriculture in the latter year. In 1872 an occasion arose for exhibiting his peculiar power of combining men of various political opinions in a common sympathy for the grievances of the rural ratepayer in carrying by a majority of 100, against one of the strongest governments of modern times, a resolution insisting on the necessity of local taxation reform. Joining the Government of 1874, Sir Massey Lopes found opportunities for less well known but very important services to the State in another direction in the part he played in improving the management of the Greenwich Hospital estates of the Admiralty, and in the reorganisation of several of the Admiralty departments at home and abroad. In the eighties his services to agriculture were again in request; and the subsequent success of the movement for a separate Department of Agriculture, although not completed till after he had retired from Parliamentary life, in 1885, owed much to the earlier efforts he made in its support. His public services were recognised on his retirement by his being sworn of the Privy Council.

As a landlord he enjoyed the confidence of his tenantry, while his unrivalled clearness of judgment in the discharge of public business, and his capacity for enlisting and maintaining the most cordial relations with those who had the good fortune to serve him were conspicuous features of a long and honorable career, the close of which must be a matter of deep regret to all his former colleagues who have enjoyed at one time or another the great benefit of his sage advice.

## THE LINCOLN SHOW, 1907.

FOR the second time in the history of the Society, the Annual Show has been held in the city of Lincoln; the previous occasion on which the Society visited Lincolnshire being the holding of the Sixteenth Exhibition in the year 1854, during the second Presidency of the late Mr. Philip Pusey, M.P., who had previously filled the office in 1841.

Subjoined are some particulars respecting the numbers of entries, admissions, and financial results at the two Lincoln Shows of 1854 and 1907, and the Derby Show of 1906 :—

Year	Place of Meeting	President of the year	Implements entered	Entries of live stock	Number of persons paying for admission	(+ = Profit — = Loss)
1854	Lincoln.	Mr. Philip Pusey	1,897	736	37,635	— £1,002
1906	Derby .	Mr. F. S. W. Cornwallis	4,772	2,319	119,143	+ 2,088
1907	Lincoln.	Earl of Yarborough .	4,728	2,576	133,006	+ 6,066

The County of Lincoln now possesses three distinct breeds of live stock to which it gives its name, viz., Lincolnshire Red Short-horn Cattle, Lincoln Long-wool Sheep, and Lincolnshire Curly-Coated Pigs. Of these breeds the Lincoln Long-wool Sheep only had Classes in 1854, but on the present occasion Classes were provided for each of the breeds, which were fully represented.

As at Derby in 1906, the County Agricultural Society decided to forego their own show for the year, and held a "one day" Exhibition of live stock and produce in the Showyard on Friday, June 28. Members of the Lincolnshire Agricultural Society were accorded the privileges of free admission to the Show and reduced fees for entries as in the case of Members of the Royal Agricultural Society.

The Horticultural Exhibition was arranged and carried out by the Lincoln Local Committee under the Chairmanship of Mr. Charles E. Scorer, and the splendid collections displayed in the two large tents have rarely, if ever, been excelled at any previous Exhibition in this country.

The Agricultural Education and Forestry Exhibitions have been separately reported on (see pp. 152 and 161).

### THE SHOWYARD.

The previous Show of 1854 was held on eleven acres of land (known as the Cowpaddle) on the South Common, the site of which is now covered partly by the workshops of an Engineering firm and partly by dwelling houses.<sup>1</sup>

<sup>1</sup> An illustration of the Showyard of 1854, showing the Cathedral in the background, appeared as the frontispiece to Volume 67 of the Journal, 1906.

The 1907 Showyard was situated on the West Common inside the Carholme Racecourse, and covered an area of 125 acres, being larger by about forty-five acres than the site on which the Derby Show was held last year. The main entrance buildings were erected at the southern end of the ground facing Alderman's Walk, with approaches from Carholme Road and West Parade.

The site provided was exceptionally well adapted to the purposes of a showyard and for the setting out of the various sections in the most convenient and satisfactory manner. As might possibly be expected at Lincoln, there was a splendid exhibition of agricultural implements and machinery of all kinds, both at rest and in motion. The Implements and Machinery were located in one almost square block of shedding, intersected by nine avenues—an arrangement which was of considerable assistance to those visitors who were interested in this particular portion of the Show.

Readers of this report may be interested to know that the 125 acres comprising the Showyard were enclosed by nearly two miles of fencing, whilst the rows upon rows of shedding erected for the accommodation of exhibits would—if they could have been placed end to end—have reached a distance of more than  $6\frac{1}{2}$  miles. In addition, exhibits shown in the open without shedding covered an area amounting to two acres.

The decoration and furnishing of the Royal Pavilion was carried out very successfully by Messrs. Curtis and Mawer, of Silver Street, Lincoln, and during the week, after the King's visit, the public were allowed to inspect the rooms on payment of a small charge. This arrangement was very popular and a great number of visitors passed through the rooms, the proceeds being handed to the authorities of the Lincoln County Hospital. A novel feature in connection with the Royal Pavilion was that the Pollard oak furniture was manufactured in the city of Lincoln from timber grown in the county within four miles of the site of the Show.

The floral decorations and the excellent arrangement of the flower-beds and lawn in front of the pavilion were carried out by Messrs. Pennell & Sons, High Street, Lincoln.

The miniature lakes, with pools and weirs, which provided such agreeable features in the Showyard, were really ponds which had been converted by Messrs. Pulham & Son, of 71 Newman Street, London, W.

#### THE SHOW.

The Show extended over five days, opening on Tuesday, June 25, and closing on the following Saturday, June 29. On the Monday rain fell heavily, in consequence of which the

state of the ground caused the officials not a little anxiety. Fortunately there was an improvement on the following day, and although the Show commenced under unseasonable conditions, the Society was favoured with fair weather during the remainder of the Show until late in the afternoon of Saturday, when it rained very heavily. The judging of the breeding classes in the Live Stock section was commenced on Tuesday morning, and occupied nearly the whole of the day.

On the second day (Wednesday, June 26) the weather, during the visit of His Majesty The King, was all that could be desired. His Majesty, who was accompanied by The Grand Duke of Hesse, travelled by special train from King's Cross, and after receiving an Address from the Corporation at the Lincoln Railway Station proceeded direct to the Showyard. On his arrival, the King was conducted by the Honorary Director to the Royal Pavilion, where His Majesty was received by the President (the Earl of Yarborough), Members of the Council, and representatives of the Local Committee. His Majesty then visited various sections of the Showyard, and subsequently honoured the President with his presence at luncheon in the Royal Pavilion, at which there were also present Members of the Council and representatives of the City and County of Lincoln. After luncheon, His Majesty drove to the Horticultural Exhibition, and having inspected the flowers and plants, drove to the Horse Ring, stopping on the way to examine a splendid selection of cattle which had been arranged in a special ring. His Majesty remained in the Royal Box of the Grand Stand for about an hour watching the parades, and left the Showyard at 3.30 p.m. on his return to London. In honour of His Majesty's visit, the Mayor of Lincoln gave a banquet on Wednesday evening to the Council of the Society at the County Assembly Rooms.

The Earl of Yarborough presided over the General Meeting of Members held on Thursday, June 27. The meeting was largely attended and great interest was taken in the announcement of the awards of the Judges in the Farm Prize Competitions. (A full report of these Competitions will be found on page 166). The thanks of the Members were unanimously accorded to the Mayor and Corporation and the Local Committee for their efforts in connection with the Show.

The Show was visited on Thursday by H.M. The King's Indian Orderly Officers, Risaldar-Major Purusottam Singh, Risaldar Thakur Mul Singh, Subadar Rohtan Singh, and Subadar Gopala, accompanied by Major A. W. Pennington. These officers were received by the President and the Honorary Director, and were subsequently conducted by the Stewards

rough the different parts of the Show, and were much arrested in the various exhibits.

On Friday the "Local" Classes of the Lincolnshire Agricultural Society were judged in the Showyard, the animals entered in this section being required to remain in the Yard for one day only. On Saturday the Local Committee arranged most successful and interesting Military Tournament which is given by the Lincolnshire Imperial Yeomanry. It was perhaps unfortunate for the Society that the Channel Fleet was being off Grimsby on Saturday, as undoubtedly a great many visitors who would otherwise have attended the Show were attracted to Cleethorpes and Grimsby, to both of which places excursion trains were run by the Railway Companies.

The Band of the Second Battalion of the Lincolnshire Regiment, conducted by Mr. A. R. Hurst, performed selections of music in the Showyard during the week.

**ENTRIES.**

At the first Lincoln Meeting the total value of the prizes offered was 1,510*l.*, as compared with the very liberal prize list offered this year, amounting to 8,589*l.*, a sum which has only been exceeded on two occasions—at the International Shows held at Kilburn in 1879, and at Windsor in 1889. Of the total amount, 2,607*l.* was contributed by the various and, Herd and Flock Book Societies, 1,000*l.* by the Lincoln Local Committee, and 139*l.* by the Lincolnshire Agricultural Society.

The following Table shows the entries of Live Stock and amount of shedding allotted in the Implement Yard compared with the seven previous Shows and the Lincoln Meeting of 1854:—

*Live Stock, Poultry, and Produce.*

	Lincoln, 1907	Derby, 1908	Park Royal, 1908	Park Royal, 1904	Park Royal, 1908	Carlisle, 1902	Cardiff, 1901	York, 1900	Lincoln, 1854
<b>Animals</b> . . .	1,506	1,563	1,372	1,365	422	521	355	696	108
<b>Shedding</b> . . .	11,030	1926	898	867	944	667	553	687	189
<b>Produce</b> . . .	1,672	1,564	591	525	520	545	519	614	303
<b>Other</b> . . .	368	266	252	227	222	178	148	—	139
<b>Total</b> . . .	2,576	2,319	2,113	1,984	2,108	1,911	1,575	1,997	739
<b>Poultry</b> . . .	826	811	871	603	763	653	701	629	295
<b>Produce</b> . . .	572	525	493	544	609	461	521	528	25

<sup>1</sup> Exclusive of Double Entries.  
<sup>2</sup> Exclusive of Draught Horses and Harness Classes.

## Shedding in Implement Yard (in feet).

Description of Shedding	Lincoln, 1907	Derby, 1906	Park Royal, 1905	Park Royal, 1904	Park Royal, 1903	Carlisle, 1902	Cardiff, 1901	York, 1900	Lincoln, 1884
	Feet	Feet	Feet	Feet	Feet	Feet	Feet	Feet	Feet
Ordinary	7,650	7,818	8,590	7,630	9,360	6,693	7,245	9,454	—
Machinery-in-Motion	2,185	2,520	1,750	2,069	2,670	2,079	2,305	2,547	—
Special (Seeds, Models, &c.)	3,251	2,692	1,629	2,032	2,555	2,321	2,101	2,771	—
Total [Exclusive of open ground space]	13,086	13,030	9,969	11,722	14,585	11,093	11,651	14,772	—
No. of Stands.	417	424	289	350	456	340	358	412	131

The statement on page 95 shows how the prizes were distributed over the different sections of the Exhibition, and gives the number of classes and entries in each.

## AUCTION SALES IN THE SHOWYARD.

The popularity of these auctions in the Showyard does not show any tendency to decrease, as evidenced by the fact that the number of animals entered *for sale* at Lincoln was larger than on any previous occasion. As will be observed, however, from the table printed below, the total amount realised was about 700*l.* less than at Derby in 1906, the cattle and sheep figures showing a falling off.

	1903			1904			1905			1906			1907		
	£	s.	d.	£	s.	d.	£	s.	d.	£	s.	d.	£	s.	d.
Horses	564	18	0	724	10	0	327	12	0	123	18	0	347	11	0
Cattle	2,377	14	6	3,517	10	0	6,117	6	0	10,034	6	6	8,707	13	0
Sheep	48	6	0	421	1	0	1,316	13	6	2,045	18	6	2,027	19	6
Pigs	281	13	6	412	18	3	424	9	3	572	5	0	951	19	3
Total	3,272	12	0	5,075	19	3	8,186	0	9	12,776	8	0	12,035	2	9

## THE ATTENDANCE.

Although the weather had been for some time of the most unfavourable character, and did not show much improvement until after the opening day, the Society were most fortunate in having a comparatively fine week. The attendance (133,006) exceeded the expectations of the most sanguine persons interested in the success of the Show, including the Railway Companies, whose arrangements for the carriage and accommodation of visitors was evidently made in anticipation of much smaller numbers. As will be seen from the figures given in the Tables on page 96, the number of visitors to the Lincoln Show was the largest since the Cardiff Meeting of 1901, when the total reached was 167,423.

STATEMENT OF PRIZES, CLASSES, AND ENTRIES  
AT THE SOCIETY'S SIXTY-EIGHTH ANNUAL EXHIBITION,  
LINCOLN, 1907.

HORSES, ASSES, AND CATTLE				SHEEP, PIGS, POULTRY, PRODUCE			
	Prizes	Classes	Entries		Prizes	Classes	Entries
<b>HORSES:—</b>	£ s.	No.	No.	<b>SHEEP:—</b>	£ s.	No.	No.
Hunter	316 0	10	89	Oxford Down	80 0	4	33
Polo and Riding Ponies	139 10	5	33	Shropshire	170 0	7	78
Cleveland Bay	80 0	3	10	Southdown	119 10	6	69
Coach Horses	80 0	3	13	Hampshire Down	100 0	5	55
Hackney	310 0	10	63	Suffolk	108 0	6	39
Hackney Ponies	108 0	4	15	Dorset Horn	72 0	4	21
Shetland Ponies	33 0	2	9	Ryeland	54 0	3	11
Riding Classes (Hunters, and Polo and Riding Ponies) <sup>1</sup>	275 0	8	60	Kerry Hill	72 0	4	22
Harness Horses and Ponies <sup>1</sup>	265 0	13	54	Lincoln	447 10	10	145
Jumping	329 0	7	63	Leicester	72 0	4	29
Pace and Action	70 0	2	8	Cotswold	80 0	4	16
Shire	310 0	9	101	Border Leicester	50 0	3	15
Clydesdale	220 0	7	26	Kent or Romney Marsh	98 0	5	59
Suffolk	172 10	6	26	Wensleydale	51 0	3	13
Draught Horses	80 0	2	4	Devon Long Wool	45 0	3	6
Asses	14 0	2	3	South Devon	30 0	2	9
				Dartmoor	30 0	2	5
				Exmoor	30 0	2	5
				Cheviot	30 0	2	7
				Lonk	30 0	2	6
				Herdwick	30 0	2	4
				Welsh Mountain	30 0	2	16
				Black-faced Mountain	20 0	2	9
<b>Total for HORSES and ASSES.</b>	<b>2,800 0</b>	<b>92</b>	<b>577</b>	<b>Total for SHEEP</b>	<b>1,829 0</b>	<b>87</b>	<b>672</b>
				<b>PIGS:—</b>			
<b>CATTLE:—</b>				Large White	105 5	5	84
Shorthorn	435 0	14	348	Middle White	95 5	5	36
Lincolnshire Red	316 0	12	102	Tamworth	95 5	5	44
Short-horn	150 0	6	70	Berkshire	100 10	5	90
Hereford	101 0	4	35	Large Black	121 0	5	68
Devon	89 0	3	12	Lincolnshire			
South Devon	178 0	6	41	Curly-coated	82 0	4	46
Sussex	85 5	3	10				
Welsh	150 10	7	50	<b>Total for PIGS</b>	<b>599 5</b>	<b>29</b>	<b>368</b>
Red Polled	140 0	6	62				
Aberdeen Angus	140 0	6	25	<b>TOTAL for STOCK</b>	<b>7,819 10</b>	<b>310</b>	<b>2,647</b>
Galloway	80 10	4	19				
Highland	101 0	4	11	<b>POULTRY</b>	<b>180 5</b>	<b>87</b>	<b>826</b>
Ayrshire	60 0	3	91				
Jersey	160 0	8	46	<b>PRODUCE</b>	<b>229 15</b>	<b>48</b>	<b>572</b>
Guernsey	120 0	6	18				
Longhorn	92 0	5	25	Competitions—			
Kerry	108 5	4	52	Horse-Shoeing	27 0	2	130
Dexter	128 5	5	10	Farm Prizes	300 0	4	163
Special Milk <sup>1</sup>	35 0	1	5				
Butter Test <sup>1</sup>	108 10	1	5	Swath Turners and Side Delivery Rakes	52 10	2	15
<b>Total for CATTLE</b>	<b>2,561 5</b>	<b>102</b>	<b>1,030</b>				

<sup>1</sup> Exclusive of Double Entries.

## (1) Admissions by Payment at Lincoln, 1907.

Day of Show	11 a.m.	1 p.m.	3 p.m.	5 p.m.	Day's total
Tuesday (5s.) . . . . .	664	1,317	1,631	1,680	1,680
Wednesday (2s. 6d.) . . . . .	9,398	18,564	21,541	22,779	22,836
Thursday (2s. 6d.) . . . . .	7,651	18,091	21,907	22,675	22,725
Friday (1s.) . . . . .	22,537	44,014	50,693	51,819	51,888
Saturday (1s.) . . . . .	16,871	26,982	32,355	33,821	33,878
Total Admissions . . . . .					133,006

## (2) Total daily admissions at Lincoln, 1907, compared with previous six Shows.

Prices of Admission	Lincoln, 1907	Derby, 1906	Park Royal, 1905	Park Royal, 1904	Park Royal, 1903	Carlisle, 1902	Cardiff, 1901
Implement Yard only (2s. 6d.) . . . . .	—	—	—	—	—	2,372	—
Five Shillings . . . . .	1,680	2,752	—	2,011	2,685	2,321	3,155
Half-crown . . . . .	22,835	25,666	2,770	9,375	12,057	7,550	23,745
Half-crown . . . . .	22,725	—	7,684	10,912	11,403	15,398	25,063
One Shilling . . . . .	51,888	46,055	7,754	14,175	20,569	46,242	69,133
One Shilling . . . . .	33,878	44,670	5,770	16,457	18,299	19,304	46,327
Totals . . . . .	133,006	119,143 <sup>1</sup>	23,978 <sup>2</sup>	52,930 <sup>3</sup>	65,013	93,187	167,423

<sup>1</sup> Derby, 1906—Only one Half-crown day.

<sup>2</sup> Park Royal, 1905—No Five Shilling day; third day, price of admission (2s. 6d.) reduced to 1s. after 3 p.m.

<sup>3</sup> Park Royal, 1904—Second and third days, price of admission (2s. 6d.) reduced to 1s. after 4 p.m.

## IMPLEMENT DEPARTMENT.

The Report on the Trials of Swath Turners and Side Delivery Rakes will be found on page 121, and the Report on the Miscellaneous Implements on page 130.

## DESCRIPTION OF EXHIBITS.

The following particulars are based mainly upon the reports furnished by the Judges of the various classes. Illustrations are this year given of the champion horses, cattle, sheep, and pigs, numbering 48 in all; and a complete list of the awards is given in the Appendix, preceded by the names of the Stewards and Judges in the different departments.

## HORSES.

The entries in this section were 506 (exclusive of double entries and entries in the competitions), as compared with 563 at the Derby Show of 1906.





**FIG. 1.—HUNTER FILLY.**

*Winner of Champion Prize for best Hunter Filly registered or entered in the Hunter Stud Book, Lincoln, 1907. Exhibited by MR. FREDERICK G. COLMAN.*



**FIG. 2.—HUNTER MARE, "EVERLASTING."**

*Winner of Champion Prize for best Hunter Mare, 4 years and upwards, Lincoln, 1907. Exhibited by MR. JOHN A. MULLENS.*



**FIG. 3.—POLO AND RIDING PONY STALLION, "SPANISH HERO."**  
*Winner of Champion Prize for best Polo and Riding Pony Stallion or Colt, Lincoln, 1907.*  
*Exhibited by MR. STEPHEN MUMFORD.*



*Journal R.A.S.E., Vol. 68, 1907.*

**FIG. 4.—POLO AND RIDING PONY FILLY, "DEBORAH."**  
*Winner of Champion Prize for best Polo and Riding Pony Mare or Filly, Lincoln, 1907.*  
*Exhibited by MR. JOHN BARKER M.P.*

On this occasion the Veterinary Examination of Horses was made before the animals entered the Judging Ring. The several Veterinary Inspectors commenced their duties at 6 a.m. on the Tuesday, under the direction of the Steward of Veterinary Arrangements, Mr. Cyril E. Greenall, and, so successfully was the work carried out, that by the time appointed for the judging to begin, the examination had been completed.

In addition to the competitive classes there was a special exhibit of draught horses in harness, *not for competition*. This exhibit, which included Mr. J. Ogden Armour's grey Percheron geldings, Mr. A. C. Sparkes' and Mr. R. C. Cooper's Shires, and Sir Cuthbert Quilter's Suffolks, proved a very attractive feature, and the several teams in the course of their daily parades excited considerable interest amongst the onlookers.

As an acknowledgment of the general excellence of these exhibits the Council awarded the Society's silver medal to each of the four owners of the teams.

**Hunters.**—These numbered eighty-nine in the ten classes provided for breeding animals. The Judges reported that "these classes, as a whole, were composed of rather moderate animals. The fillies were better than the colts." The yearling fillies (Class 4) made a good show, some of them being very promising, with good substance. Classes 7 and 8 included a number of very nice types of brood mares. The animals which gained the Hunters' Improvement Society's Gold Medals are the subjects of illustration (see Figs. 1 and 2). The hunters shown under saddle included some of the best horses in England, and the competition was very keen.

**Polo and Riding Ponies.**—The breeding classes contained a large percentage of very high-class stock. In Class 15 several lovely brood mares were shown, some being excellent. The riding classes contained several valuable animals.

**Cleveland Bays and Coach Horses.**—There were only ten animals entered in the three classes for Cleveland Bays. The entries of Coach Horses numbered thirteen, four of which were absent. The Judge reports that the first prize winner, No. 124, in Class 16 (Cleveland Bay stallions, foaled in 1904 or 1905) was a well-grown horse with capital legs which he can use. No. 129, which gained the first place in Class 17 (Cleveland Bay fillies, foaled in 1904 or 1905), was a mare with capital action and the best of legs. No. 132, first prize winner in Class 18 (Cleveland Bay mares, with foals at foot), was a very good mare with strength, quality, and action, calculated to breed a good hunter to a thoroughbred sire. The second prize mare, No. 131, had less shoulder action and had not the style of the first prize winner. No. 137, first in Class 19 (Coaching stallions, foaled in 1904 or 1905), had the best of legs with very

straight good action and will make a good horse in time, though shown in poor condition. The second (No. 138) was a fine horse, but rocked a little in his action. No. 140 in Class 20 (Coaching fillies, foaled in 1904 or 1905) was a very fine filly with extravagant action. The winner in Class 21 (Coaching mares, with foals at foot), No. 144, was a typical mare with the best of action.

**Hackneys.**—These numbered sixty-three as against seventy-six at Derby last year. The Judges report that Class 22 (Hackney stallions, foaled in 1906) was fair though a small entry, the winner being a promising colt. Class 23 (Hackney stallion, foaled in 1905) was a better class all through. Class 24 (Hackney stallion, foaled in 1904) was a very good class, the first and second being Champion and Reserve for Champion. The former, *Copmanthorpe Performer* (see Fig. 5), has plenty of bone and substance and made a great show. Classes 25 and 26 (fillies foaled in 1906 and 1905 respectively) were both good, the winner in the latter class, Sir Walter Gilbey's *Lively Beeswing*, placed Reserve for Champion Medal, being a very good filly. In Class 27 (fillies foaled in 1904) the winner stood out by herself. Class 28 (mares with foals at foot, over 14 h., and not exceeding 15 h. 2 in.) were a moderate class, the winner being quite an old-fashioned type. Class 29 (mares, with foals at foot, over 15 h. 2 in.) were good all round, the first prize animal, Mr. R. P. Evans' *District Maid*, taking the Gold Medal. Of the foals (Classes 30 and 31) the fillies were much better than the colts.

**Hackney Ponies.**—These classes (32 to 35) were badly filled and, taken as a whole, were a moderate lot.

**Shetland Ponies.**—These ponies were represented by eight exhibits, of which two only were stallions. The winning stallion pony, *Thoreau*, was of the thick blocky type, of medium size, with plenty of bone, symmetry, and action not easily surpassed, and was of quite exceptional merit. This animal also won the Shetland Pony Society's Silver Medal (see Fig. 6). The other pony (No. 225), was also good and would have made a creditable winner had the first prize animal been absent. In Class 37 (mares) the winner was easily found in No. 230, Mr. R. W. R. Mackenzie's *Strawberry*, an extra good mare nine years of age, showing lots of quality with true Shetland character and first class action. This animal was placed Reserve for Champion. There were several other good ponies in the class, though the best of them fell far short of the winner.

**Harness Horses and Ponies.**—The number and quality of the animals competing in the thirteen classes were very satisfactory. The Special Prize for the best Hackney mare or gelding, the produce of a Registered Hackney Stallion, was



**FIG. 5.—HACKNEY STALLION, "COPMANTHORPE PERFORMER."**  
*Winner of Champion Prize for best Hackney Stallion, Lincoln, 1907.*  
*Exhibited by MR. ARTHUR HALL.*



**FIG. 6.—SHETLAND PONY STALLION, "THOREAU."**  
*Winner of Champion Prize for best Shetland Pony, Lincoln, 1907.*  
*Exhibited by THE LADIES E. AND D. HOPE.*



**FIG. 7.—SHIRE STALLION, "RATCLIFFE FOREST KING."**  
*Winner of Champion Prize for best Shire Stallion, Lincoln, 1907.*  
*Exhibited by MR. FRANK FARNSWORTH.*



*Journal R.A.S.E., Vol. 68, 1907.*  
**FIG. 8.—SHIRE FILLY, "BARDON MARION."**  
*Winner of Champion Prize for best Shire Mare or Filly, Lincoln, 1907.*  
*Exhibited by MR. W. T. EVERARD.*

awarded to Mr. S. R. Tennant for *Authority*, the first prize winner in the class for mares or geldings over 15 h. and not exceeding 15 h. 2 in. The Reserve No. for the Special Prize was Miss Dora Schintz's dark chestnut gelding, *Morocco*, the first prize winner in the over 15 h. 2 in. novice class, No. 49, and also first prize winner in the open over 15 h. 2 in. class.

**Pace and Action.**—In these two classes seven animals only competed, three in Class F (not exceeding 15 h.) and four in Class G (over 15 h.). The first prizes winner in both classes were the property of Mr. Walter Winans, and were American bred.

**Jumping.**—The competitions this year included two classes for high jumping, for which twenty-five entries were received. The first prize of 50*l.* offered in Class H on Friday was won by Mr. Thomas Glencross, with *Blink Bonny*, and the first prize of 30*l.* in Class I on Saturday by Mr. C. Appleyard, with *Playmate*.

**Shires.**—The Judges in their report observe that “the mares were superior to the stallions, of more uniform character, and the Champion and Reserve for Champion were excellent animals. The leading fillies in their respective classes were good, and a general improvement could be noticed throughout.” The yearling colts were a strong class; No. 352, a big good colt, looked like growing into a good sire. The two-year-old stallion class was headed by a very correct animal, with good legs and feet. The three-year-old class was a good one and produced the Champion, *Ratcliffe Forest King* (No. 372), a good weighty stallion (see Fig. 7). No. 373 in the same class, a good upstanding colt, was Reserve for Champion.

**Clydesdales.**—The Judge reports that the first prize winner in Class 68 (No. 450), was a very good colt and looked like making a valuable sire. In Class 69, the first prize winner was an extra good colt, and a good mover, having size, quality of bone, the best of feet and pasterns. This animal was also Champion (see Fig. 9). The second prize colt was a little plainer in the body than the first, but had big, good bone. The third and reserve number were also very useful animals. The first prize winner in Class 70 was a good, thick, well-made horse, very gay in its movements. The second was also a good horse, in many points perhaps as good as the first, but not so good in action. The first in Class 71 had the best of feet and legs and will make a good mare. The second was also good but plainer made. The others were useful and looked like making valuable brood mares. The first prize winner in Class 72 showed great Clydesdale character. The second animal was good but did not show the character of the first. The first prize animal

in Class 73, *Pyrene* (see Fig. 10), was also awarded the Female Championship. She is an extra good mare, very strong in every point, and cannot be beaten.

**Suffolks.**—The two-year-old stallions (Class 75) turned up in fair numbers and made a good show. The three-year-olds (Class 76) contained some excellent horses, amongst which was found the Champion in Mr. Kenneth M. Clark's *Sudbourne Arabi*, a typical Suffolk (see Fig. 11). The two-year-old fillies (Class 77) were rather disappointing. Perhaps, however, the Show was too far off; if not, it makes one wonder where the dams of the future stallions are coming from. Only four three-year-old fillies were shown (Class 78), but these were a good lot and all worthy of commendation. Only two mares with foals at foot came into the ring (Class 79), but these were very good mares indeed. Taken as a whole, the entries were good but short in number.

**Draught Horses.**—Only four exhibits were shown in this section, but they were all useful horses.

**Asses.**—The Spanish stallion entered in Class 82 was a good jack with size, bone, and good general conformation, and would be useful for getting mules and improving English donkeys. The first in Class 83 was a well-bred Spanish mare with jack foal at foot—good conformation with good bone. The second was a well shaped mare, with size and bone, and promises to turn out well.

#### CATTLE.

The entries in this department numbered no less than 1,030 animals, a total which has only been exceeded on one occasion, namely, at the Windsor Meeting of 1889, when there were 1,144 entries. The Shorthorns were again the most numerous, and a fresh record was created by the entry of 348 animals of this breed, being twenty-nine in excess of the number received last year.

**Shorthorns.**—The Judges report that the three bulls placed in Class 84 were outstanding animals, the first, *Linkfield Champion*, being also Champion (see Fig. 12). In Class 85 there was no outstanding winner, with the exception of the first prize bull. In Class 86 there was little to choose between the three prize-winners. The first in Class 87 was a good-coloured, evenly balanced bull, and a fairly easy winner. A number of the animals in this class were only of moderate merit. Class 88 was composed of only moderate animals, no exhibit being of special account. The Champion Female, *Sweetheart* (see Fig. 13), was found in Class 90, and was an easy winner. Class 91 contained only seven exhibits, but the three winners were very good and promising animals. Class 92 was very strong, the first prize heifer being an outstanding





**FIG. 9.—CLYDESDALE STALLION, "DIPLOMA."**  
*Winner of Champion Prize for best Clydesdale Stallion, Lincoln, 1907.*  
*Exhibited by MESSRS. A. AND W. MONTGOMERY.*



**FIG. 10.—CLYDESDALE MARE, "PYRENE."**  
*Winner of Champion Prize for best Clydesdale Mare or Filly, Lincoln, 1907.*  
*Exhibited by MR. J. ERNEST KERR.*



**FIG. 11. SUFFOLK STALLION, "SUDBOURNE ARABI."**  
*Winner of Champion Prize for best Suffolk Stallion, Lincoln, 1907.*  
*Exhibited by MR. KENNETH M. CLARK.*



*Journal R.A.S.E., Vol. 68, 1907.*  
**FIG. 12.—SHORTHORN BULL, "LINKSFIELD CHAMPION."**  
*Winner of Champion Prize for best Shorthorn Bull, Lincoln, 1907.*  
*Exhibited by MR. F. MILLER.*



**FIG. 13.—SHORTHORN COW, "SWEETHEART."**  
*Winner of Champion Prize for best Shorthorn Cow or Heifer, Lincoln, 1907.*  
*Exhibited by LORD CALTHORPE.*



**FIG. 14.—SHORTHORN DAIRY COW, "PRICELESS PRINCESS."**  
*Winner of Champion Prize for best Shorthorn Dairy Cow or Heifer, Lincoln, 1907.*  
*Exhibited by MR. C. R. W. ADEANE.*



**FIG. 15.—LINCOLNSHIRE RED SHORT-HORN BULL, "SCAMPTON EXILE."**  
*Winner of Champion Prize for best Lincolnshire Red Shorthorn Bull, Lincoln, 1907.*  
*Exhibited by MR. BENJAMIN ROWLAND.*



*Journal R.A.S.E., Vol. 68, 1907.*  
**"SCAMPTON SKIPWORTH 5TH."**  
*Winner of Champion Prize for best Lincolnshire Red Cow or Heifer, Lincoln, 1907.*  
*Exhibited by MR. BENJAMIN ROWLAND.*

winner. Class 93 was another large and very good one, there being little to choose between the prize winners.

**Shorthorn Dairy Cows.**—The winner in Class 94 (eleven exhibits) was an exceptionally grand type, showing what the pure-bred Shorthorn is capable of doing as a dairy cow. This animal, *Priceless Princess*, was also awarded the Dairy Shorthorn Championship (see Fig. 14). The second prize cow was a grand animal, and well deserved her position, being also Reserve Number for the Dairy Shorthorn Championship. The third prize cow was of a different type, a large-framed animal not showing the breed characteristics of the two former, but carrying a well developed udder, and giving a large yield of milk. The five exhibits in Class 95 showed the care which has been taken by breeders to develop the dairying properties of the breed. In Class 96 (five exhibits) the care shown in breeding was even more apparent, the milk of these two-year-old heifers reaching 26 lb., and another entry which had been nearly four months in-milk, very closely approached this weight, and although yielding the large quantities of milk carried good form and flesh.

**Lincolnshire Red Short-horns.**—There has never, in the opinion of the Judges, been such a fine collection of this breed exhibited either in point of numbers (102) or excellence of quality. Both in the cow class, with calves at foot, and in the dairy classes, they were excellent, as also the young cow class, viz., three-year-olds. The Champion Cow (see Fig. 16) stood out clearly, a winner not only in her class, but as Female Champion. The heifers calved in 1906 made a very large class, but here again the winner stood far ahead of all her competitors, and eventually won a special prize. The male section was not anything so strong as the female, but the bull awarded the Championship was a very easy winner (see Fig. 15).

**Herefords.**—The first prize winner in Class 110, *Pearl King* (see Fig. 17), was a big bull, with good flesh, but rather off his hind legs. This animal also secured the Male Championship. The second was a nice quality bull, lacking in his hind quarters. The third, a big masculine stock bull, was rather coarse in his points. Class 111 was very good, the first being a very neat bull with a wonderfully good top. The second was a nice bull with a lot of scale and likely to make a good stock bull. The third dropped a little in his back leg standing. The first prize bull in Class 112 was of good quality, also likely to make a good stock bull, and the second was a very good level animal, but had not the substance of the other. The third was a thick heavy bull, rather light in his hind quarters. In Class 113 the first prize cow was of good quality. The second was rather

over-fed, but had a good calf. There was not much to choose between the first two in Class 114, and the third, though young, was a beautiful heifer. The first in Class 115, a fine heifer full of quality, was Female Champion (see Fig. 18). The second was a very nice animal, but not quite so level as the first.

**Devons.**—The Judge reports that in the old bull class nine entries came into the ring, and a right good lot they were. The winner is a grand massive specimen of the breed, walks well, and afterwards won the Champion Prize for the best male (see Fig. 19). The second is of quite a different type, very straight and even, not so massive, and might walk a little better. The third and reserve were both good bulls, and would win in most cases. These four animals, the best seen together for some time, are of outstanding merit and did not give their younger competitors a chance. The younger bulls were not so good either in quality or numbers, not one of them being of extra merit. Six came out in the cow class. The winner was a nice typical three-year-old, with a good calf, and easily first. She also won the Champion for the best female (see Fig. 20). The second cow was rather weak in front, but had a good bag and calf. The younger female class produced ten exhibits, the first being an easy winner. The second was the youngest in the class, and was very even and should make a good cow. The third was rather weak at the tail-end.

**South Devons.**—The Judge reports that the bull class was an excellent one, though small in number. In the female class some specially good cows and heifers were shown, several of which were also entered in the milking competition.

**Sussex.**—Class 123 contained only two exhibits, but these were fine specimens. *Lord of Drungewick 5th*, first prize and Champion (see Fig. 21) was a little weak over the shoulder, but otherwise a perfect animal. In Class 124 there was very little to choose between the first and second, the latter being a little weak behind the shoulders. The third prize bull was of very choice quality, with exceptionally good skin, but a little weak on thighs. Considering the distance from the home of the breed, which is unfortunately principally confined to Kent and Sussex, the classes were well filled with excellent animals; in fact it was one of the best shows of the breed that has been before the public for a long time. The first prize animal in Class 126, *Sunlight 7th*, was of very nice quality, and representative of the breed. This cow afterwards succeeded in gaining the Championship (see Fig. 22). The second and third prize winners were good specimens of the breed. In Class 127 *Tilsden Jessie*, a splendid fleshy animal, but inclined to be cock horned, was placed first, and was later Reserve for Champion.



**FIG. 17.—HEREFORD BULL, "PEARL KING."**  
*Winner of Champion Prize for best Hereford Bull, Lincoln, 1907.*  
*Exhibited by MR. ALLEN E. HUGERS.*



**FIG. 18.—HEREFORD HEIFER, "LEMSTER PLUM."**  
*Winner of Champion Prize for best Hereford Cow or Heifer, Lincoln, 1907.*  
*Exhibited by MR. ALLEN E. HUGHES.*



**FIG. 19.—DEVON BULL, "POUND PINK 'UN."**  
*Winner of Champion Prize for best Devon Bull, Lincoln, 1907.*  
*Exhibited by THE HON. E. W. B. PORTMAN.*



*Journal, R. A. S. E., Vol. 68, 1907.*  
**FIG. 20.—DEVON HEIFER, "CAPTON ROYAL SALLY."**  
*Winner of Champion Prize for best Devon Cow or Heifer, Lincoln, 1907.*  
*Exhibited by MR. E. C. NORRISH.*





**FIG. 21.—SUSSEX BULL, "LORD OF DRUNGEWICK 5TH."**  
*Winner of Champion Prize for best Sussex Bull, Lincoln, 1907.*  
*Exhibited by MR. ERNEST E. BRAHY.*



**FIG. 22.—SUSSEX HEIFER, "SUNLIGHT 7TH."**  
*Winner of Champion Prize for best Sussex Cow or Heifer, Lincoln, 1907.*  
*Exhibited by EARL WINTERTON.*



**FIG. 23.—RED-POLLED BULL, "ALAKE."**  
*Winner of Champion Prize for best Red-Polled Bull, Lincoln, 1907.*  
*Exhibited by THE RIGHT HON. A. E. FELLOWES.*



*Journal R.A.S.E., Vol. 68, 1907.*  
**FIG. 24.—RED POLLED HEIFER, "ASHLYNS MAID."**  
*Winner of Champion Prize for best Red-Folled Cow or Heifer, Lincoln, 1907.*  
*Exhibited by SIR RICHARD P. COOPER, BART.*

Class 128 was a good one, the first and second being very typical animals, the third was rather too much of Devon type for the breed.

**Welsh.**—The entries in Class 129 (bulls), were a very fine lot, the winner, *Duke of Connaught*, a lengthy, level bull, with mellow touch, fine coat, well-sprung ribs, and a fine countenance, was easily first. This animal also obtained the Special Prize for best bull. The second prize bull was a fine upstanding animal with a capital coat, good touch and very deep. The remaining animals were all good, but do not call for special notice. Only two animals were exhibited in Class 130, and both possessed superior merit. The first prize cow was a deep milker, with fine coat and touch, and was brought out in the "pink" of condition, and won easily. The other cow was a really fine animal, lengthy, level, with nice touch, and was well worthy of the second prize. The winner in Class 131 was a beautiful heifer, full of style and true Welsh character. The second and third prize heifers were level, thick, broad beasts, and did credit to their owners.

**Red Polled.**—A very creditable display was made in this section, the numbers being fair and the quality good. The old bull class contained five noted animals, all having taken prominent positions at previous shows. *Alake*, a most beautiful even-fleshed animal of the right type led the way, being followed by another good-fleshed bull, showing much quality, but his hocks standing too close together rather spoiled the appearance of an otherwise very fine animal. The third prize in this class went to a very massive bull. *Alake* (see Fig. 23) also won the Championship, and is a great credit to the breed. Bulls calved in 1905 and 1906 made up two fairly good classes. The winner in the latter class showed much quality, and should come to a good animal. The largest class was that for cows. The winner here was very level, and showed great milking properties. The second cow was also very nice in quality and colour of good type, and had a large and well-shaped udder. There were several cows in this class entered for Milk Yield Prizes, and they were not in the usual show form. Heifers calved in 1905 were perhaps not quite such a good class, but in the next, for heifers calved in 1906, the Female Champion, *Ashlyns Maid*, was found (see Fig. 24). This was a grand animal, and perhaps one of the best yearlings seen for a long time.

**Aberdeen Angus.**—Class 139 contained two or three good bulls, especially the first and second. The former, *Idelamere* (see Fig. 25), was awarded the English Aberdeen Angus Cattle Association's Gold Medal. In Class 140 eight of the ten were noticed, but beyond the first two or three, the others were not

more than fair. Class 141 was perhaps the weakest of the breed, for with the exception of the prize winners, the entries were of rather poor quality. Class 142 was composed of some very good animals, particularly the prize winners, and on the whole was perhaps the best class of the breed in the Showyard. The first prize cow, *Juana Erica* (see Fig. 26), gained the Polled Cattle Society's Champion Gold Medal as the best animal of the breed exhibited. Class 143 was a fair average one, all the animals receiving notice, except one. Class 144 was the largest of the breed, though in point of merit, there was nothing particularly outstanding. The prize winners were promising animals of good type. The Judges report that on the whole the entries were satisfactory, and that the animals shown were a good representation of the breed, little over-feeding being perceptible.

**Galloways.**—This breed made a very good show indeed. The entries totalled 25, and many of the best representatives of the breed were on exhibition. The first prize aged bull, *Chancellor of Ballyboley* (see Fig. 27), to which was afterwards awarded the Male Championship, has been a great winner at the National and other Shows, and he never looked better. The second prize bull in this class was also an animal of fine Galloway character. The first prize young bull was a nice straight animal, which looked like developing into a grand old bull. The second, third, and reserve bulls were also very good. The first prize cow, *Flora Macdonald* (see Fig. 28), which took the Female Championship, has been a frequent winner at the leading Shows, and the second prize cow was also a good one. In the heifer class the winners were very superior animals.

**Highland.**—The four classes provided for this picturesque breed attracted nineteen entries. The bulls made a first-class show, with the exception of two of the yearlings. The first prize winner in Class 149 for old bulls, Mr. Ian Bullough's *Albannach* (see Fig. 29), was also awarded the Male Championship. The cows were also a very good lot, and so were the heifers, some of them being the best Scotland could show. The Female Championship was won by Mr. D. A. Stewart's *Laochag Bhuidhe Ath of Ensay* (see Fig. 30), first prize winner in Class 151 (Cows or Heifers, in-milk, calved before or in 1904).

**Ayrshires.**—The bulls (Class 153) made an extra good show, the first prize winner being, in the opinion of the Judge, the best animal he has seen in the last ten years. The second was a really good bull, being a two-year-old out classed. The third was an outstanding yearling. The cows and heifers (Class 154) were a good lot, the first prize going to a grand,



FIG. 25.—**ABERDEEN-ANGUS BULL, "IDFLAMERE."**  
*Winner of Champion Prize for best Aberdeen-Angus Bull, Lincoln, 1907.*  
*Exhibited by MR. T. H. BAINBRIDGE.*



FIG. 26. **ABERDEEN-ANGUS COW, "JUANA ERICA."**  
*Winner of Champion Prize for best Aberdeen-Angus Animal Lincoln, 1907.*  
*Exhibited by MR. J. ERNEST KERR.*

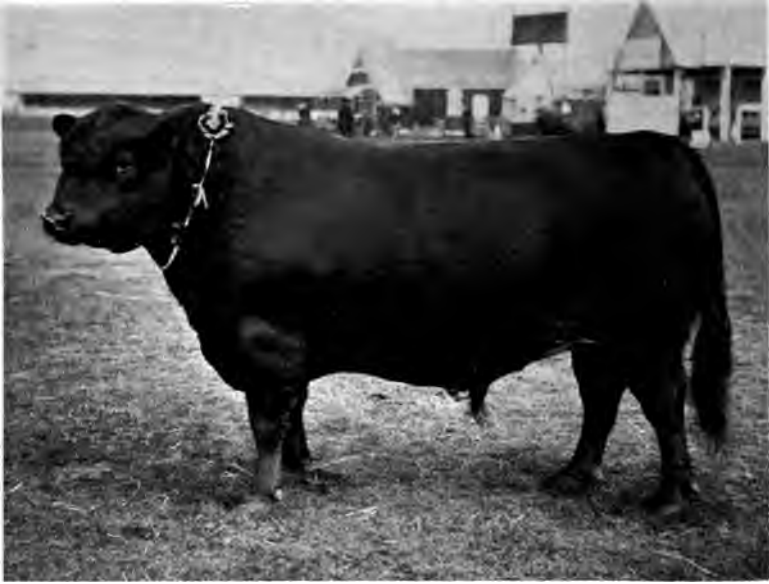

**FIG. 27.—GALLOWAY BULL, "CHANCELLOR OF BALLYBOLEY."**  
*Winner of Champion Prize for best Galloway Bull, Lincoln, 1907.*  
*Exhibited by MR. JOHN CUNNINGHAM.*



*Journal R.A.S.E., Vol. 68, 1907.*  
**FIG. 28.—GALLOWAY COW, "FLORA MACDONALD."**  
*Winner of Champion Prize for the best Galloway Cow or Heifer, Lincoln, 1907.*  
*Exhibited by MESSRS. THOMAS BIGGAR & SONS.*

level cow with long well-attached milk vessel and well-set teats.

**Jerseys.**—The Judges, in their report, “congratulate the Society on bringing together such a typical and generally first-rate lot of cattle,” and they were “pleased to find after judging that so many of the best animals were home-bred as distinguished from imported specimens.” In Class 156 (bulls calved in 1902, 1903, 1904, or 1905), the Judges found considerable difficulty in placing the winners, and the exhibits in Class 157 (yearling bulls) were so even that the awards caused great trouble to adjust. Classes 158 and 159 (cows and heifers) were exceptionally fine throughout, and the exhibits were equal to, if not better than, any the Judges remember seeing at a “Royal” Show. Class 160 (heifers in-milk, calved in 1905) was truly representative. Class 161 (yearling heifers) was very even throughout, and several of the animals were distinctly meritorious.

**Guernseys.**—The Judges report that the exhibits were very good, particularly as regards quality. Numerically they are not quite as strong as they have been on some former occasions, Lincoln being a little out of the Guernsey district, added to which a number of cattle have been exported of late, and one or two exhibitors have disposed of their herds. But, as others are coming forward, larger classes may be looked for in the future. Under these circumstances an average of nine per class must be considered satisfactory. Class 164 contained some grand old bulls, the winner, four years old, retains the good form he showed as a calf. He was followed by a bull of much the same style a year younger; the third prize going to a bull yet a year younger, a good dairy looking bull, with the best head of the three, but his chine and tail end will not compare with the others. Class 165 (bulls born in 1906) were a very good class, the winner a very smart and taking animal but hard pressed by a youngster of great promise only born in August. Class 166 (cows and heifers calved previously to or in 1904) contained several animals of various type. The first two were small but very level with good bags. The third was a cow of quite another type but very good, save for a coloured nose. Class 167 (heifers calved in 1905) was by far the worst class; the winner has a bad head and coloured nose and is small, but she is level and has a good shaped bag. The two following were bad at the tail end and the reserve was too coarse. Class 168 (heifers calved in 1906) was capital. The winner has the best bag, but was pressed hard by the three which follow her.

**Longhorns.**—The entry of the breed was not as large as might have been desired, still, it was sufficiently large to

compare as quite an average one, and to maintain the standard of this famous old breed of cattle. Sixteen animals were entered. The first class (bulls calved in 1902, 1903, 1904, or 1905) contained four entries, and these were a remarkably good lot. The first prize was awarded to an outstanding specimen, *Fradley Conqueror*, very typical in breed character, exhibited by Mr. W. L. Riley, sired by the famous bull "Wychnor Secundus." The exhibits of Mr. T. Basil P. Levett and Mr. W. H. Sale, placed second and third respectively, were also quite remarkable animals, both in size, symmetry and quality. Lord Gerard's bull, which could not get higher than reserve, was also a very massive, weighty specimen. The class for bulls calved in 1906 contained only a single entry, but this animal was considered of sufficient merit to be awarded the first prize. Cows or heifers in-milk, calved previously to or in 1904, made, perhaps, the best class of the section, containing six animals of great merit. In making the awards in this class, the Judge fully recognised the dual purpose character of this breed, and gave priority to *Lady Panza*, a cow of great scale, fine outline, and correct breed character, with a capacious and well-shaped udder. This cow was afterwards first in the milk yield Class, 174. Very fine cows were also exhibited by Lord Gerard, who obtained second prize with one and highly commended with another. Mr. C. Tollemache Scott also contributed two very good entries, placed third and reserve. Heifers calved in 1905 or 1906, with four entries, were rather variable on account of age. The two prizes were awarded to grandly developed heifers of Lord Gerard's, *Grace 11th* and *Empress of Eastwell*. Mr. W. H. Sale obtaining reserve and highly commended for two younger heifers of considerable promise.

**Kerries.**—There was a very good entry in the female classes, but the bulls were not so numerous. Of the five entries of the latter sex, *La Mancha Diver*, exhibited by Mr. R. Tait Robertson, gained the first prize, Lady Greenall's *Walton Rajah*, a very straight bull, being placed second, and Sir Clifford Cory's *Walton Margrave* third. *La Mancha Diver* (see Fig. 31) also won the Challenge Cup offered by the English Kerry and Dexter Cattle Society for the best Kerry animal. In the cow class some of the entries showed very milky type and good breed character. Lady Greenall's *Aicme Cold* was placed first, Mr. G. L. Palmer's *Mollig Dhubb* second, and Sir Clifford Cory's *Patricia an Ceathramhadh* third. Heifers calved in 1905 or 1906 had an entry of ten, amongst them several showing good quality and breed character. Sir Clifford Cory's *Lluntarnam Lucy* was accorded premier honours in this class.





**FIG. 29.—HIGHLAND BULL, "ALBANNACH."**  
*Winner of Champion Prize for best Highland Bull, Lincoln, 1907.*  
*Exhibited by MR. IAN BULLOUGH.*



**FIG. 30.—HIGHLAND COW, "LAOCHAG BHUIDHE 4TH OF ENSAY."**  
*Winner of Champion Prize for best Highland Cow or Heifer, Lincoln, 1907.*  
*Exhibited by MR. D. A. STEWART.*



**FIG. 31. -KERRY BULL, "LA MANCHA DIVER."**  
*Winner of Champion Prize for best Kerry Animal, Lincoln, 1907.*  
*Exhibited by MR. R. TAIT ROBERTSON.*



Copyright 1907 by R. Tait Robertson

**Dexters.**—There was an exceptionally good muster in all the Classes for this breed, and the general quality was very satisfactory. In the Class for bulls calved in 1902, 1903, 1904, or 1905, the Sandringham herd obtained the first prize with *King John*, a very good and typical specimen, bred by His Majesty. Cows and heifers in milk made a great show, the Duchesses of Devonshire's *Compton Daphne* (see Fig. 32), a typical animal, being awarded the first prize in her Class. The English Kerry and Dexter Cattle Society's Challenge Cup for the best Dexter animal exhibited was also won by this cow. The three-year-old heifers made a good class, the Hon. Mrs. Claud Portman securing first prize with *La Mancha Hard-to-Find*. The class for heifers calved in 1905 or 1906 attracted fourteen entries, the Duchess of Devonshire obtaining first prize with *Compton Diana*.

**Butter and Milk Tests.**—A full report by the Steward of Dairying upon these Tests is printed on pp. 138 to 152.

#### SHEEP.

On this occasion the number of sheep entered was 672, as compared with 564 at Derby. As might be expected, the largest entry was made in the Classes for Lincoln Long Wools, of which there were 145. Shropshires came next with 78 entries.

**Oxford Downs.**—These Classes were well filled and deserving of great merit. The first prize shearling ram was a very good sheep and typical of the breed. The second, third, and fourth prize sheep were a great credit to their owners. The ram lamb class included some very good pens, the first prize pen being very early lambs, the second and third—of beautiful quality—were much younger. The shearling ewe class was a strong one, and the first and second prize pens were of great merit, in fact all the entries were extremely good. The ewe lambs were as good as any of the Oxford down section, the first and second prize pens were remarkable for their similarity and quality.

**Shropshires.**—Upon the whole the exhibits were quite up to the average of previous years. In Class 190 (two-shear rams), the entry was small. The first prize ram was an outstanding winner with good lean flesh, a capital fleece and legs well placed. The second prize ram was a useful sheep that came well to hand. Class 191 (shearling rams) consisted of twenty-four entries. Here the winning sheep was easily found, with good back and ribs well sprung, legs well placed, and fleece and skin fairly good. The second prize animal was a typical Shropshire, with good fleece and skin, and walked well. The third prize sheep was "sirey," but rather backward in condition.

The leading pen in Class 192 (pens of five shearling rams) were well brought out and had great substance with good lean flesh and nice wool. The second prize pen contained some typical "sires" good in their wool with perfect skins and nice style. The third prize went to a pen of good-fleshed sheep with wool of the correct class. Class 193 ("*Special Selling*" shearling rams) was not a satisfactory class, although the four leading sheep showed character and good breeding. In Class 194 (pens of three ram lambs) the prize pens were generally meritorious, containing several promising "sires." Class 195 (pens of three shearling ewes) contained a small entry, but excellent in quality and the two leading pens were outstanding winners. The ewe lambs (Class 196) were of average merit.

**Southdowns.**—The six classes provided for this breed attracted a really good entry of sixty-nine. In Class 197 (two shear rams) the first prize winner, *Fairlawn*, was an excellent and typical ram, choice in his flesh with good character. This animal also won the Southdown Sheep Society's Gold Medal for best Southdown ram (see Fig. 34). In the shearling ram class (198) the competition was particularly keen, the first prize going to Sir Jeremiah Colman for a well-fleshed ram with a good head. This sheep was Reserve for Gold Medal. The pens of three shearling rams (Class 199) formed an interesting competition, three deep-fleshed rams exhibited by the Exors. of the late Col. H. McCalmont being placed first. The ram lambs (Class 200) were of superior merit and excellent in character, three lambs of nice type shown by the Duke of Devonshire gaining first place, an excellent pen shown by H.M. The King being second. Competition in the shearling ewe class was very keen. Sir Jeremiah Colman secured the first prize, and with the same animals won the Silver Medal for the best pen of females (see Fig. 35). In a strong class of ewe lambs H.M. The King won first honours with a very uniform and good-fleshed pen of animals.

**Hampshire Downs.**—The Judges report that this section was a very excellent one; the two-shear ram class and the lamb classes were of exceptional merit. Better old sheep than the winner in the former are seldom seen, and perhaps never a better pen of ewe lambs than the first in their class.

**Suffolks.**—There was an excellent show of the breed. In every class there were some good typical specimens. In the two-shear ram class the first, second, and third prize sheep were very good. In the shearling rams there were some very good sheep, with quality and good wools. The ram lamb class contained some well-grown lambs, the first, second, and third prize pens being of very good, nice quality, good in colour and wool. The first and second prize pens in the class for three ram lambs

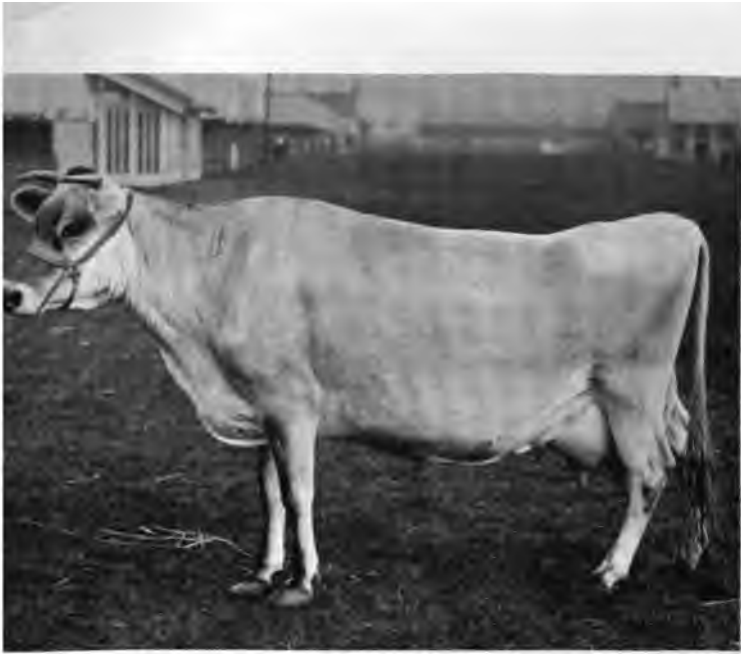

FIG. 33.—JERSEY COW, "WENCH."  
*Winner of Gold Medal for best Jersey Cow in the Butter Tests, Lincoln, 1907.*  
*Exhibited by THE MARQUIS OF WINCHESTER.*



FIG. 34.—SOUTHDOWN TWO-SHEAR RAM, "FAIRLAWN."  
*Winner of Champion Prize for best Southdown Ram, Lincoln 1907.*  
*Exhibited by MR. W. M. CAZALEY.*



**FIG. 35.—SOUTHDOWN SHEARLING EWES.**  
*Winners of Champion Prize for best pen of Ewes or Ewe Lambs, Lincoln, 1907.*  
*Exhibited by SIR JEREMIAH COLMAN, BART.*



*Journal R.A.S.E., Vol. 68, 1907.*  
**FIG. 36.—HAMPSHIRE DOWN EWE LAMBS.**  
*Winner of Champion Prize for best pen of Hampshire Down Ram Lambs or Ewe Lambs, Lincoln, 1907.*  
*Exhibited by MR. JAMES FLOWER.*

were very matchy and well grown. Shearling ewes were short in numbers, only three pens being exhibited. The first prize pen were not as big as the second, but were of rather better quality. The ewe lamb class was the best. All the pens were good, and more difficulty was found in awarding the prizes in this class than in any of the others, as there were several pens very even in merit, being very matchy and good in colour and wools.

**Dorset Horn.**—This breed was fairly well represented, the sheep shown being very good in all classes. The yearling ram of Mr. E. A. Hambro showed much quality and was a good specimen of the breed. The ewes made a good class, showing the points of the breed well. The ram lambs also showed good size, quality, and wool. The especial feature were the ewe lambs, which were extremely good, showing all their points well.

**Ryeland.**—Taken altogether, the exhibits were better than usual. The first prize in Class 218 was a very good sheep of excellent quality and wool. Between the second and third there was not much to choose. Class 219 were a nice lot, but small in numbers. Some of Class 220 were very nice sheep, particularly the first and second.

**Kerry Hill.**—Considering the distance of Lincoln from the hills of Wales, the exhibitors are to be commended for their venture in bringing these beautiful sheep to the front, at the Royal Show. The class of aged rams was a strong one, and sheep true to type and character were shown. Yearling rams were few; the yearling ewes were a special feature of the Show, especially the first and second prize pens, the third pen were very good. The ewe lamb class was a strong one, and the prize winners were typical of the breed. Considering the lateness of the shearing season, and that none of these sheep are housed, they came out well.

**Lincolns.**—This breed made a show in itself, the entries being 145, which resulted in nearly 400 sheep of various ages being shown. The quality of the winners throughout was excellent. Class 225 contained some good rams, the first prize animal, also winner of the Special Prize (see Fig. 37), had the appearance of being a most impressive sire. The shearling rams were a strong class, the first was an outstanding winner. The pens of five rams made a grand collection; especially the prize pen. Ram lambs showed Lincoln character, but backward compared with some years. The shearling ewes were a very good class, and there was not much to choose between the winning pens. To the ewe lambs the same remark applies as to ram lambs. Class 233 (yearling ewes in the wool) was a

wonderful exhibition, some remarkable sheep being shown. The first prize pen also won the Special Prize for females (see Fig. 38). For true Lincoln character and wool, it is very doubtful if anything equal has ever been previously shown.

**Leicesters.**—Class 235 was very good, and it was rather difficult to judge the merits of some of the exhibits, the sheep being very much alike. With the exception of the first and second pens, Class 236 was rather disappointing, no doubt owing to the lambs being starved through the wet weather. Class 237 was excellent, some of the exhibits being of first rate quality. The first and second pens had capital fleeces and good firm flesh, and were well grown. Class 238 was not so good owing to the same cause mentioned in connection with Class 236. The first pen were well woolled and of fair quality. The other pens rather backward in condition but nice quality.

**Cotswold.**—The entries were few in number, but of good quality, and representative of the breed. In the shearling ram class the first prize animal was an outstanding sheep of great merit. In the class for ram lambs the first prize pen were very true to type and the second were well grown and of great length. The shearling ewes exhibited were of excellent quality. Only two pens of ewe lambs were shown, but these were very handsome.

**Border Leicesters.**—On the whole this section was rather disappointing. The first prize old sheep was a very representative type, and would take a high place in any company. There was nothing outstanding in the shearling class, not one of them having the right class of wool. The first prize gimmers were a specially well-matched pen showing good Leicester character.

**Kent or Romney Marsh.**—The first prize winner in Class 246 was an excellent sheep, with good wool, and quite typical of the breed. Class 247 was very strong indeed and of excellent quality all round, the first prize sheep was all that could be desired for a Kent or Romney Marsh shearling. The second and third were also of prime quality with good bone and wool. This class was good throughout. The ram lambs (Class 248) were good, particularly the first prize pen. The shearling ewes (Class 249) were very good, and difficulty was found in separating the prize winners. The ewe lambs (Class 250) were all well shown.

**Wensleydales.**—All the classes were of very nearly equal merit, and consequently the awards were rather difficult to determine.





**FIG. 37.—LINCOLN TWO-SHEAR RAM, "NOCTON ENERGY."**  
*Winner of Special Prize, for competition by members of the Lincolnshire Agricultural Society only,  
for the best Lincoln Two-Shear or Shearling Ram, in Classes 225 and 226, Lincoln, 1907.  
Exhibited by MR. F. MILLER.*



**FIG. 38.—LINCOLN YEARLING EWES.**  
*Winners of Special Prize, for competition by members of the Lincolnshire Agricultural Society only,  
for best pen of Lincoln Shearling Ewes, Ewe Lambs, or Yearling Ewes, Lincoln, 1907.  
Exhibited by MR. C. E. HOWARD.*



**FIG. 39.—BORDER LEICESTER RAM, "PITLIVIE BRILLIANT."**  
*Winner of Champion Prize for best Border Leicester Ram, Lincoln, 1907.*  
*Exhibited by MR. ROBERT TAYLOR.*



*Journal R.A.S.E., Vol. 68, 1907.*  
**FIG. 40.—LARGE WHITE BREEDING SOW, "COLSTON LASS 13TH."**  
*Winner of Champion Prize for best Large White Boar or Sow, Lincoln, 1907.*  
*Exhibited by MR. R. MILLINGTON KNOWLES*

**Devon Long Wools.**—In these classes there was only one exhibitor, and to him all the prizes were awarded. The exhibits were good specimens of the breed, and fully deserved the honour.

**South Devons.**—The entries present were very typical of their breed, particularly the winning two-shear ram.

**Dartmoors.**—These classes were not well supported, but it was satisfactory to find a fresh exhibitor interested in them.

**Exmoors.**—Class 261 was very good, and the Judge found it difficult to decide between the first and second prize rams. In Class 262 the first prize pen (No. 2165) were three very excellent ewes.

**Cheviots.**—Although small in numbers they were a good lot, there not being a bad sheep in them. The first old sheep had a very good head and skin and was a good handler. The second, a shearling, was a good sort. The first and second gimmers were very equal, and would take a deal of beating in any company.

**Lonks.**—The first prize ram in Class 265 was a very good specimen, but just a little too low in his horns. The one to which the second prize was awarded was a nice looking sheep, but not so good in his hind legs, he also did not walk with the freedom he ought to. The remaining ram was a fairly good one, only too small to compete with those awarded first and second, as he is only a shearling. Class 266 (three shearling ewes)—two in pen No. 2178 awarded first prize are almost perfect Lonk sheep, the third is rather light in colour on the face, and its horns are a little too close to its head. Those awarded second were also good sheep, but not so strong in the bone as those awarded first, and not quite so good in colour. The remaining pen was still weaker in build and inferior in quality.

**Herdwicks.**—The ram awarded first prize in Class 267 was excellent, good in colour and coat, also very hard looking. The one awarded second was younger, and not so good in colour or fleece, still a good sheep, perhaps on a rather larger scale than the first. The pen of three shearling ewes, to which was awarded first prize in Class 268, was one of very good shearlings forming a nice equal lot and well worthy of their position. Those awarded second were a very good lot, but smaller in bone and build, still they form a fairly equal pen.

**Welsh.**—In Class 269 (rams, shearling and upwards) there were several very excellent specimens of the pure Welsh breed, and the prize winner is an exceptionally good sheep, with a fleece that will withstand the cold, and protect the back and

loins in the hardest winter on the exposed mountains. The exhibits in Class 270 (pen of three shearling ewes of the same flock) were all of the true Welsh mountain type, and the winning pen were a perfect match, full of the feminine character, firm, close fleeces, and that bright countenance so pleasing to the eye, which is of such value in the market.

**Black-faced Mountain.**—Three two-year olds and one shearling were shown. A very good lot, but not easily judged as both ages were competing together. Two pens of shearling ewes were shown, they were well bred and well brought out for show. Both classes would pass well in any show in Great Britain.

#### PIGS.

The entries numbered 368, creating another record, being 102 more than at Derby in 1906, when the pig section attracted the previous record entry. This year, however, four classes were provided for the Lincolnshire Curly-Coated Pigs in which there were forty-six entries. Five classes were provided for each of the other breeds.

**Large Whites.**—Class 273 was a good class of boars. The first prize winner was full of quality and a good haired pig. The second though more lengthy was true to type. Class 274 was a very strong one, the winner a grand young boar with good back and loins. The winner in Class 275 was full of quality and true to type; the second will make a fine sow. Class 276 varied in type a good deal, though the prizes went to good ones. The exhibits in Class 277 were not very matchy, but they were good useful pigs. The Special Prize for the Lincolnshire best large white boar was awarded to No. 2224, the second prize boar in Class 273. The Champion Gold Medal for the best large white boar or sow was awarded to the first prize sow in Class 275 (see Fig. 40).

**Middle Whites.**—Although this section was the weakest (numerically) of all the pig classes, the quality left nothing to be desired. The whole of the animals shown were very true to type and of excellent quality. Class 278 contained four old boars, the winner (2293) a long pig with good size but not coarse. No. 2294 was second—a very neat pig, but smaller than the winner. No. 2292 gained third honours, a younger pig shown in splendid form, but head not so perfect as the two placed before him. Class 279 (young boars) contained several very good young pigs, the winner, No. 2301, however, was well ahead of the others. No. 2296, a well-grown pig, was placed second, and No. 2300 third, closely followed by No. 2299 for reserve, these three boars were very nearly equal in merit. Class 280 (old sows) was a small but very good class, the winner 2306, a two-and-half-year-old sow combining size and



**FIG. 41.—MIDDLE WHITE BREEDING SOW, "WALTON ROSE 39TH."**  
*Winner of Champion Prize for best Middle White Boar or Sow, Lincoln, 1907.*  
*Exhibited by SIR GILBERT GREENALL, BART.*



**FIG. 42.—TAMWORTH SOW, "WHITACRE GRACE."**  
*Winner of Champion Prize for best Tamworth Boar or Sow, Lincoln, 1907.*  
*Exhibited by MESSRS. F. W. GILBERT & Co.*



**FIG. 43.—BERKSHIRE BOAR, "HIGHMOOR CURIO."**  
*Winner of Champion Prize for best Berkshire Boar, Lincoln, 1907.*  
*Exhibited by MR. G. T. INMAN.*



*Journal R.A.S.E., Vol. 68, 1907.*  
**FIG. 44.—BERKSHIRE BREEDING SOW, "POLEGATE DORCAS 2ND."**  
*Winner of Champion Prize for best Berkshire Sow, Lincoln, 1907.*  
*Exhibited by THE DUCHESS OF DEVONSHIRE.*

quality shown in excellent form. This sow won the medal for champion pig in the section (see Fig. 41). The second, No. 2308, a very good sow, heavy in farrow and suffering from a cold, was apparently feeling the effects of travelling about to previous shows. Class 281 was another good class of eight sows, farrowed in 1906. The first, 2313, not so forward as some of the others was of excellent type, good coat and head, and likely to make a good brood sow. No. 2314 was a very similar sow and placed second. No. 2311 was third, a bigger sow altogether. Class 282 (pens of three young sows) contained eight exhibits; No. 2323 won first, a pen of good pigs matching well and excellently shown. No. 2325, placed second, also matched well, and were three long, good pigs, likely to win another year. No. 2326, third, were not so forward in condition but of good type. Some of the pens did not match well, although each contained good individual pigs.

**Tamworths.**—The Tamworth pig section was well represented in all classes. In Class 283 (old boars) the winner was the youngest boar in the class, showing good quality and correct colour, the second and third prize boars were also good specimens. Class 284 (young boars); the winner here was an exceptionally good boar, the second and third winners were also very good specimens. Class 285 (old sows) was the smallest class in the section, but the prize winners were good sows, especially the first prize sow (No. 2353) which was also placed Reserve for Championship. In Class 286 (sows farrowed in 1906) the winner, No. 2356 was an exceptionally good specimen of the breed, and was eventually awarded the Championship (see Fig. 42); the second and third prize sows were very promising animals, good colour, and free from black spots. In Class 287 (three sows farrowed in 1907) the winners, No. 2367, were well grown, good colour, and free from black, as also were the second prize pen. The third prize pen were well grown, not so good in skin and coat.

**Berkshires.**—No. 2380, first prize in Class 288, a grand boar with size, great length, and nice quality, was also awarded the Championship (see Fig. 43). The same can be said of the second and third prize animals, the latter had been a little overdone and lost its hair. The whole class were good and most of them had H.C. or C. cards. There was no difficulty in selecting No. 2397 for first prize in Class 289. This was a boar of nice size, beautiful quality, and good markings. No. 2395 was also a smart boar. No. 2403 showed such great length and size that made it an easy third. No. 2396 would have held a higher position had not the lower jaw been slightly twisted. The old Berkshire sows were a strong class. No. 2413 possessed beautiful quality combined with size and was placed

first and afterwards awarded Female Champion (see Fig. 44). No. 2421 was also a grand sow, and rightly deserved second prize. No. 2412 was also a sow of great merit as were several others in the class. Class 291 (sows farrowed in 1906) was also a strong class, and the extraordinary size and weight of No. 2427 made her an easy first. No. 2429 is also a good sow, and so are Nos. 2435 and 2425. Class 292 (pens of three sows farrowed in 1907) was very strong. No. 2447 were easy winners of the first prize, but some difficulty was found in selecting the second and third, Nos. 2450 and 2445. The whole class was so good that nearly all of them were commended.

**Large Black.**—There was an excellent show all round of Large Black pigs, and keen competition. In Class 293 there were some excellent boars, but of rather different types. The young boars in Class 294 were equally good, and the sows in Class 295 were a really splendid lot. Classes 296 and 297 were also strong.

**Lincolnshire Curly-Coated.**—In Class 298 the competition was very close for premier honours, the first and second prize animals being typical Lincolnshire Curly-Coated pigs; the third prize animal showing great wealth of lean flesh, but coat rather too coarse for a typical Lincolnshire Curly-Coated pig, a defect to be guarded against. The first prize winner here also gained the Male Championship (see Fig. 47). Class 299 (boar pigs farrowed in 1907) must be quoted as the weakest of the classes exhibited, the first prize animal a very good specimen, an extraordinary winner, fairly backed up by the second and third prize animals, whilst the reserve, No. 2550, was one of the best on its legs, with good head and ears, and tail well set, but lacking in muscle and natural lean flesh. Class 300 (sows farrowed in 1903, 1904, 1905, or 1906) made a very good show indeed, the first prize animal and Female Champion (see Fig. 48), being a typical specimen of what a Lincolnshire Curly-Coated sow ought to be. This animal was closely run by the second prize one, also a grand specimen of the breed, but a tendency to droop in the hind quarters, with her tail low set, caused her to take only second honours. The third prize animal, a grand pig, showed a certain coarseness of coat, which is more objectionable in a sow than in a boar. Class 301 was the best of the four classes, the pen of three that were awarded first prize were a grand trio, and had one of these been eligible to compete for the Special Prize in the female classes, it would have had no difficulty in carrying off the coveted trophy; the second prize winners were also a grand pen and close runners for place, but scarcely showing such a superabundance of lean flesh as the first prize winners; the third prize winners were also well worthy of their place.





**FIG. 45.—LARGE BLACK BOAR, "BRENT PRIDE 2ND."**  
*Winner of Champion Prize for best Large Black Boar, Lincoln, 1907.*  
*Exhibited by MR. HENRY J. KINGWELL.*



**FIG. 46.—LARGE BLACK BREEDING SOW, "TREVEGLOS HOPEFUL 2ND."**  
*Winner of Champion Prize for best Large Black Sow, Lincoln, 1907.*  
*Exhibited by MR. JOHN WARNE.*



**FIG. 47.—LINCOLNSHIRE CURLY-COATED BOAR, "WHAPLODE CURLY."**  
*Winner of Champion Prize for best Lincolnshire Curly-Coated Boar, Lincoln, 1907.*  
*Exhibited by MR. JOSEPH WARD.*



*Journal R.A.S.E., Vol. 68, 1907.*  
**FIG. 48.—LINCOLNSHIRE CURLY-COATED BREEDING SOW, "MIDVILLE A1."**  
*Winner of Champion Prize for best Lincolnshire Curly-Coated Sow, Lincoln, 1907.*  
*Exhibited by MR. HENRY CAUDWELL.*

## POULTRY, INCLUDING GEESE, DUCKS, AND TURKEYS.

In this department there were as usual three judges appointed. The entries numbered 826, being slightly in excess of the 1906 figure (811), though the classification and prizes had been somewhat curtailed. The increase in the entries was no doubt attributable to the fact that the fees had been reduced, and the time for receiving entries extended. Mr. John Saul judged the Game fowls, Leghorns, Ducks, Geese, and Turkeys; Dr. E. S. Jackson judged the Langshans, Plymouth Rocks, Wyandottes, and Orpingtons, and Mr. Clem Watson judged the Dorkings, Sussex, Brahmas, Cochins, French, Minorcas, Andalusians, and Table fowls. The following observations are taken from their reports:—

**Fowls.**—The Game classes made an excellent show. The winning *Old English Game* cocks stood out in a very good class. The first and second hens were well to the front, but the other entries in this class were out of condition. Of the *Old English* cockerels, the winner was very good, and the second and third were forward, but too small. The pullets were a fair quality class. The *Indian Game* cocks were a really grand class. The hens were also an excellent class, some grand birds having to be left out. The cockerels were very forward. The pullets made a very good class. *Langshans* had two classes with a total of twenty entries. *Barred Plymouth Rocks* made a good show of thirty-seven entries. The two classes for any other varieties of *Plymouth Rocks* contained twenty-seven entries, principally of Buffs and Whites. *Wyandottes* had fourteen classes, some of which were badly supported. A feature of the Show was the display of *Orpingtons*, of which there were 192 entries in the twelve classes provided. The Buff Orpington classes were well filled, and contained some very beautiful specimens. Of the *Minorcas*, the two old bird classes were well contested, the hen which headed the list being of grand shape with a wonderfully clear thick lobe. The leading cock was a fine upstanding bird with a good head and very active in character. The *White Leghorns* were fine in colour, and made two good classes. The other *Leghorn* classes were small. The winners stood out from the others, but they were not so good as the *Whites*. *Andalusians* (one class) did not come up very well, and the quality was quite of an ordinary character.

The *Dorkings* on the whole were a very fine lot, and contained all the finest specimens in the country. Of the four classes given to the coloured, the old cocks stood out, and competition was very keen. The winner was full of Dorking character, had a rare length of breast and very wide in front. Most of the hens suffered through lack of condition. The

two chicken classes were full of merit, the pullets being about the best seen at this Show for some years. In the *Any Other Colour* classes the exhibits were all *Silver Greys*. The leading cock was reserve for best in the section, and held the position well. Altogether they made a fine show. Following these were the *Sussex*, and, although not an old breed on the show bench, they made a good display. The two old bird classes were well contested, but several failed through lack of condition. Of the youngsters little need be said, the leading cockerel standing out from the rest. *Brahmas* were just a moderate lot, with the exception of the winners, and they stood well away from the others. The two *Cochin* classes were about the best seen at the Royal for many years past, the cocks surpassing all previous records. The special winner in the section was the buff cock exhibited by Mr. Geo. H. Procter, and is an exhibit worthy of special mention. With the exception of the *Faverolles*, French came up very poorly, yet of the former these made a fair display and the quality about as usual. The *Table* classes were considerably reduced, but the cross-bred class contained some good birds from the *Indian-Dorking* and *Faverolle-Dorking* crosses.

**Ducks.**—The *Aylesbury* drakes were a really grand class, beautiful in colour and of immense size. The ducks were also a real good class, the winners being hard to select, and some good ones had to be left out. The classes for *Rouen* drakes and ducks were small in numbers, but of excellent quality. The winner in the class for *Indian Runner* drakes was one of the most typical specimens living, grand in shape and colour. *Indian Runner* ducks were a good class. The first and second were near together, small and neat good ones. These are a useful duck, being excellent layers. There were some fair birds in the class for *Any Other Variety* drakes and ducks. The water fowl all through made an excellent show.

**Geese.**—There were some very large specimens shown in the gander class, the first and second went to two *White Embdens* of immense size and grand colour. The geese were also a real good class, some of the best birds in the country being shown.

**Turkeys.**—These made a good display. The winners amongst the cocks were hard to select, so many grand ones being exhibited, some weighing on to 45 lb. in weight.

#### PRODUCE.

**Butter.**—In Class 389 (box of twelve 2 lb. rolls) there were only four exhibits. The first and second prize butters were excellent, the other two samples containing too much moisture. (Class 390 (2 lb. fresh butter made up in lbs.) was an excellent

one of sixty entries. The four first prize lots were superb, flavour excellent, colour even, of splendid texture, and all presenting a neat and clean appearance. The second and third prize lots were also very good, though one or two made from scalded cream were a little rough on the palate and slightly burned. The general quality of all the exhibits was good, though a few contained too much moisture, and in some instances the samples had been carelessly made up and lacked the attractive appearance of the prize-winning lots. Taken as a whole this class was very satisfactory.

**Cheese.**—The cheese classes as a whole were quite up to the usual average in quality, and, considering the early period of the cheese season, generally reflected great credit upon the makers. The Cheddars were exceptionally good, being all rich in quality and mild in flavour. The class for Cheshires contained some very fine lots indeed, but some of the exhibits were too acid or too weak, and consequently lacked the choice aroma which is so much desired. Stiltons were too young to do themselves justice, but were very promising. Wensleydales were in a similar condition to the Stiltons, and would make good cheese later on. Double Gloucesters and Derbys were rather variable as to condition, but most of the lots shown were good meaty cheeses of improving character. In view of the close and scientific attention given to cheese making in our colonies, the Judge (Mr. John Pakeman) ventures to impress upon home makers the necessity of making fine-flavoured, appetising, rich cheese—not too acid on the one hand, and not unduly soft on the other—for there is always a good demand for it, and it was, and is, and can be, made to pay and please all round.

**Cider and Perry.**—The cider in cask (Class 397), was fairly good, a few samples only being poor, but there were none of exceptional merit. The first and second prize lots were of good body and flavour. In Class 398 (cider in bottle, made in 1906) there were twenty-three entries, some being excellent cider, but nothing of exceptional merit. A few entries were poor. The reserve exhibit was of fine fruity flavour, but had not the fermentation carried on sufficiently to constitute it as a first-class cider to keep under all conditions. If the percentage of alcohol had been higher it would have been placed much higher. Class 399 (old cider in bottle) contained fifteen entries, very few being of inferior quality. The third prize was perhaps the finest flavoured cider in the Show, but so low in alcohol that it could not be placed higher. In Class 400 (perry in bottle) there were nine entries. This class probably contained the finest sample in the Show. A few entries were not pure.

The following are the results of the chemical analyses which relate to the samples that gained prizes or commendation :—

**CLASS 397.—Cask of Cider, made in 1906.**

No.	Specific gravity	Total solids	Alcohol	Acidity	Award
		per cent.	per cent.	per cent.	
3560	1·0322	9·15	3·70	·405	1st Prize
3561	1·0342	9·26	2·85	·361	2nd Prize
3555	1·0316	8·53	2·80	·284	3rd Prize
3554	1·0276	7·74	3·03	·207	R. N. & H. C.

**CLASS 398.—One Dozen Bottles of Cider, made in 1906.**

3584	1·0318	8·02	3·10	·415	1st Prize
3574	1·0317	8·56	2·84	·479	2nd Prize
3577	1·0432	10·98	2·21	·777	3rd Prize
3565	1·0345	9·02	1·83	·361	R. N. & H. C.
3583	1·0513	13·07	1·28	·603	Com.

**CLASS 399.—One Dozen Bottles of Cider, made before 1906.**

3600	1·0333	9·02	3·0	·408	1st Prize
3590	1·0250	7·25	3·70	·385	2nd Prize
3587	1·0399	10·36	1·40	·328	3rd Prize
3593	1·0538	13·31	1·40	·75	R. N. & H. C.

**CLASS 400.—One Dozen Bottles of Perry.**

3609	1·0232	6·75	4·70	·599	1st Prize
3606	1·0454	12·24	2·87	·814	2nd Prize
3602	1·0286	8·25	3·85	·603	3rd Prize
3605	1·0423	10·93	2·20	·619	R. N. & H. C.

**Wool.**—Class 401 consisted of a good average representation of Leicester wool, well grown and in good condition. Some first class examples of Lincoln wool were shown in Class 402. It was well grown and in good condition. Many of the fleeces, however, were tied with string instead of the usual bands from the fleece. This should be avoided, as hemp mixed with wool may cause great damage to the users. A fair average selection was shown of Kent or Romney Marsh wool (Class 403), but the former particularly showed signs of tender growth and was somewhat damp. Wensleydale wools shown in Class 404 (Any other long wool) were exceptionally well grown and highly lustrous. Cotswolds were sparsely represented, but fairly good of this class. Only a bare average selection of Southdown wools (Class 405) was shown. They were fairly good of their class. The staple was sound and in good condition. Shropshire wool (Class 406) was not sufficiently

represented. The two lots exhibited were sound and in good condition. Class 407, composed of various short wools, was well represented and showed the clip to be in very good condition, well grown, and satisfactory in every way. Class 408 showed an improvement in the quality of the Welsh wool. It was well grown, sound, and in good condition. Some very good specimens of Cheviot wool (Class 409) were exhibited showing a marked tendency towards the growth of finer qualities of wool. Good specimens of deep grown Highland wool were shown in Class 410.

**Honey, &c.**—Notwithstanding the adverse bee season of 1907, the exhibits of honey and beeswax made a very fine display, occupying nearly 150 feet of staging, the total entries being 241. The system of arranging the exhibits from various counties in groups was again adopted; and for the first time local classes were arranged for the county in which the Show was held.

In the second group, Classes 419-422 (open to Midland and Northern counties, Scotland, Wales, and Ireland) a few good sections were staged, while some were quite below "Royal" Show standard. The extracted light honey was fairly good, but several nice samples were spoilt owing to the exhibitor using too much smoke or carbolic acid when removing the honey from the hives. Granulated honey (Class 422) was very good in quality, the awards going to excellent samples.

Classes 423-426 (open to southern and western counties). Here it was apparent that the south and west were more favoured than the northern counties, some excellent samples of both comb and extracted honey of the current year being staged. It was gratifying to see a very fair display in the classes for heather honey, eleven entries for sections and the same number for pressed honey in jars being staged, while the winning exhibits were of better quality than have been seen at the "Royal" Show for some time.

Of the ten open classes (427-436) that for displays of honey took first place in attracting the attention of visitors, and the merits of the fine honey trophies staged were very favourably commented on by all, the first prize one being much admired.

Class 428, for six one-pound jars of heather honey, was a good one, some excellent specimens from *Calluna vulgaris* being shown. The heather mixture (Class 429) was also very satisfactory, the awards being well deserved. Some capital samples of beeswax were shown in Class 431, the first prize sample being purchased by the British Bee-keepers' Association, on account of its excellent quality.

**Horse-shoeing Competitions.**—The larger entry was doubtless due to the increase in the number of prizes. The appreciation of such encouragement is best shown by the

long journeys many of the competitors made to be present. The shoeing done in both classes was an improvement on former years. The Judges were pleased to notice the better preparation of the foot, so essential to good shoeing. Cases of mutilation (paring out the sole, and cutting the frog) were very rare. Then, again, the shoes were better made, fitted, and nailed on than formerly, showing an all-round improvement, not only due to the instruction received by shoeing smiths in many counties, but by competitions held at the Royal and other Agricultural Societies.

In reviewing the general results, it is pleasing to record the complete success of the Lincoln Show, the achievement of which was greatly assisted by the efforts of the Corporation, the Local Committee, and the Lincolnshire Agricultural Society, who did everything in their power to make the visit of the Society as pleasant as possible. At the General Meeting of Members held in the Showyard, the following resolution was unanimously passed: "That the best thanks of the Society are due and are hereby tendered to the Mayor and Corporation of Lincoln for their cordial reception of the Society." In moving that resolution, Mr. Cornwallis recalled the fact that while it was over fifty years since they were in Lincoln before, they had with them that day their Town Clerk, Mr. J. J. Tweed, who was Mayor of the City on the occasion of the Society's previous visit in 1854.

Concerning the 1854 meeting it is reported that "A peculiar international interest was given to the proceedings by the presence of a body of gentlemen deputed specially to attend the meeting by His Majesty the Emperor of the French as a mark of his respect towards the Society and the agriculturists of the Kingdom."<sup>1</sup>

7 This year a party of French agriculturists—Members of the Association de l'Ordre National du Mérite Agricole—and a number of Swedish agriculturists attended the Show, at the conclusion of which arrangements were made for both parties to visit some of the principal farms and breeding establishments in England, including the Royal farms at Windsor and Sandringham.

**THOMAS MORROW.**

10 Bedford Square, London, W.C.



## THE TRIALS OF SWATH TURNERS AND SIDE DELIVERY RAKES AT LINCOLN, 1907.

*Judges* { Sir FRANCIS E. WALKER, Bart., Swansfield House, Alnwick.  
          { JOSHUA BALL, Southworth Hall, Warrington.

IN connection with the R.A.S.E. Show held at Lincoln in June, 1907, Silver and Bronze Medals were offered for Swath Turners, Class 1, and for Side Delivery Rakes, Class 2, together with 50*l.*, given by the Lincolnshire Agricultural Society, which sum was divided into two first prizes of 15*l.* each, and two second prizes of 10*l.* each to go with the silver and bronze medals respectively.

There were eleven entries in Class 1 from three exhibitors, and four entries in Class 2 from only two exhibitors—disappointing as regards the number of exhibitors in both classes.

Taking Class 1, the eleven entries were as follows:—one from Messrs. Jack & Sons, seven entered by Messrs. Martin's Cultivator Co., and three by Messrs. Blackstone & Co.

Messrs. Jack withdrew their machine early on in the trials, leaving Messrs. Martin and Blackstone to compete for the prizes.

All Messrs. Martin's machines are on practically the same lines, Nos. 2528, 2529 being right and left hand machines of the original type described in the Journal of R.A.S.E. for 1903, Vol. 64, pp. 238, 239, exhibited by the Harrison Patents Co., Ltd., and illustrated in the Journal for 1904, Vol. 65, on page 205, Fig. 15. Nos. 2530 and 2531 were right and left adaptations for ridge and furrow work of the 2528 type, the mechanism being the same, but the turners in these machines are placed behind the main axle, the bent frame work, to which the turners are attached, being supported at the rear end by small trailing wheels. Nos. 2532 and 2533 were right and left Triplex Swath Turners and Windrowers. In these machines one of the turning mechanisms is placed outside one of the driving wheels, enabling three swaths to be turned at the same time, and increasing the extreme width when in working order from 7 ft. 6 in. in the No. 2528 machines and 8 ft. 7 in. in the No. 2530 pattern, to 12 ft. 2 in. The positions of the turning mechanisms admit of being quickly changed, and in this way convert the machine into a windrower.

No. 2534.—A reversible machine more on the lines of the original pattern (2528), but with the front of the fore carriage carried on a swivel wheel. The mechanism is again the same, but the rake heads are constructed so that they can, by a lever, be set at any angle to the right or left, the width of this machine is somewhat reduced, being 7 ft.

122 *Trials of Swath Turners and Side Delivery Rakes.*

Of Messrs. Blackstone & Co.'s three entries one was withdrawn before the trials commenced, but two were on the ground, 3676 and 3677. No. 3676 is a very similar machine to that shown in 1904. The turning mechanism in this machine is carried by a body formed of a central longitudinal



FIG. 1.—Blackstone's Swath Turner and Hay Collector, No. 3676.

be bent down at the front end to form the pivot for a small ravel wheel, and having at the rear end a double socket attachment to two axle bars. These bars are cranked at their outer ends and carried by the travelling wheels. The inner end of each axle bar carried a double eye piece, through which the other axle bar is passed, thus keeping the double axles parallel with each other. The inner axles are toothed so as to form a rack, into which a small pinion works. This pinion is capable, by means of a key, of expanding and contracting the length of the axle, being fixed by an arrangement of wedge-headed locking bolts, in any position simply and quickly. An expanding bar hung by chains attached to a lever at the bend of the central body carries the fore-ends of the turning mechanism shafts, the rear ends being supported in connection with the gearing of the travelling wheels. The expanding bar admits of the width between the turning heads being increased in sympathy with the axle from 4 ft. to 6 ft. 6 in. centre to centre. The driver is enabled by means of this lever to raise or lower the turning heads as desired.

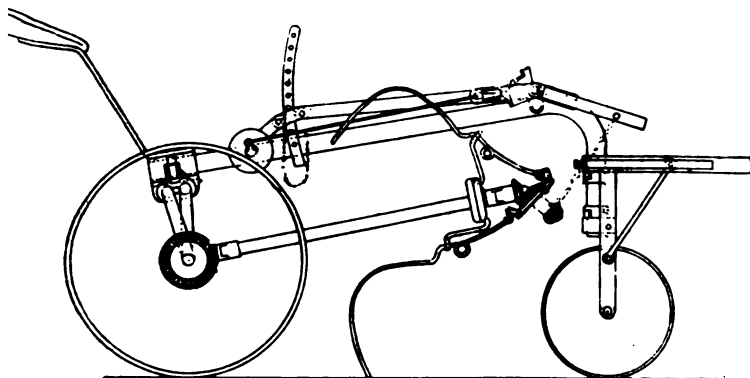

FIG. 2.—Diagram of Blackstone's Swath Turner, No. 3676.

Probably the most ingenious parts of these machines are the turning mechanisms, which consist of bent teeth, the rear ends of which are attached to the bevelled cogged head by pivotal pins and are supported in the centre by stays, the teeth being passed through an eye at one end of these stays and the other end of the stay being hooked into a hollow disc secured to the shaft as shown on the above drawing (Fig. 2). In practice this acts as an eccentric and imparts the motion required to the revolving teeth.

The chief difference between 3677 and this machine is in the turning mechanism, a system of cogged wheels being introduced into the driven head, the shaft of the turning mechanism being straight and the disc and intermediate hangers to carry the teeth being done away with.

The trials took place on a farm at Sudbrooke, in Lincolnshire, about five miles from Lincoln, in the occupation of Mr. F. Scorer, a field of permanent grass in lands, *i.e.*, ridge and furrow, and a clover field on the flat having been selected for the trials. On a portion of the field where the crop was fairly uniform eight plots had been with Mr. Scorer's assistance marked out and numbered, and each machine drew lots and was assigned to the plot the number of which had been drawn. The preliminary trials, the machines crossing the ridges at right angles, were carried out on these plots, but to insure representative machines being tried under exactly similar conditions, they were all worked on No. 3 plot, after which a trial in another part of the field took place, each machine travelling in the same direction as the ridges. Finally they had to deal with the crop in the manner that would generally obtain in practice on a farm, *viz.*, following round the four sides of a square as cut by the reaper, the machines each taking a swath, so that the work to be done by each machine was practically identical. Owing to the dull weather the crops were not, perhaps, in quite as good condition as could have been wished when the trial commenced at nine o'clock on Tuesday, June 18, although the grass and clover had been cut on the previous Thursday and Friday.

In connection with these trials the points to which the Judges' attention was specially directed were—

- (a) Mechanical construction.
- (b) Weight and draft.
- (c) Ease of handling and adjustment.
- (d) Efficient turning over of the crop.
- (e) Freedom from winding or choking.
- (f) Adaptability of windrowing as well as swath turning.
- (g) Adaptability for working on ridge and furrow land.
- (h) Adaptability for transport on road and rail.
- (i) Price.

It will perhaps be well to mention here that the Judges considered these instructions carefully, and in assessing the value to be placed on the different points or qualifications it may be remembered that (d) Efficient turning over of the

drop, should have the prominent place on the list of points, and that the other conditions should be given varying positions. Leaving out Messrs. Jack's entry and Messrs. Martin's, No. 2528, the trials were practically between three entries of Messrs. Martin's, 2530, 2532, and 2534, and two of Messrs. Blackstone's, 3676 and 3677.

Excellent work as regards turning was done by Messrs. Martin's 2534 and Messrs. Blackstone's 3676 and 3677, although at times 2534 showed a tendency to roll the swaths in the same way that 2530 and 2532 did in such a marked degree. There was much about the machine and its work that took the fancy of the Judges, and although gaining marks as regards weight and draft, it lost as regards adaptability for windrowing, ridge and furrow work, &c. This machine (2534) also has the advantage of the seat for the driver being carried behind the axles, so that, as in Messrs. Blackstone's machines, the driver can see the work going on and control it accordingly.

Messrs. Martin's other machines (2530 and 2532) both rolled the swath, leaving it ropey, and not nicely lightened up for the air to get through. As Mr. Martin assures me all his machines are, as regards the turning mechanism, height, &c., identical, I can only attribute the marked difference in the work done by 2534 to the fact of the fore carriage being carried on a small wheel, thus ensuring steadier motion than when dependent on the action of a horse. Messrs. Blackstone's 3676 gave an excellent account of itself, losing, however, a little as regards weight and draft in comparison with 2534. The work done was excellent. The swaths were well turned, left light, and in just the condition one could wish.

A word about the other two machines of Messrs. Martin's. No. 2530, adapted for ridge and furrow. This, except for the worst fault of all, "rolling the swath," which one cannot help feeling might be obviated, negotiated the ridge and furrows well, and the spring stop arrangement, by which the height of the rear wheels is adjusted, is simple and handy. The triplex, 2532, may take the fancy of some. The swaths were rolled in the same way as by the ridge and furrow machine, and the third turner evidently put a stress on the horses' shoulder on that side, which is a disadvantage, although perhaps not very apparent if the machine was only worked for a few hours.

Dynamometer tests on the following day brought the Swath Turner trials to a close. The Judges unhesitatingly awarded the first prize to Messrs. Blackstone's No. 3676, which in addition to doing excellent work, fulfilled every requirement, the second prize going to Messrs. Blackstone's No. 3677, Messrs. Martin's No. 2534 being third.

Had one of the machines proved itself an excellent Swath Turner, whilst not being able to cope with all the conditions set forth in the Society's instructions, the Judges' task might have been a very difficult one. However, the point never arose, the first prize machine being far ahead of any other competing machine in the quality of the work done.

The side delivery rake trials were held on the Friday, June 19, on the same ground. As already stated there were four entries in Class 2 from two exhibitors, viz. :— Messrs. Martin's Cultivator Co., three, Messrs. Blackstone & Co., one.

Messrs. Martin's machines were all on the same principle. Nos. 2535 and 2536 being 8 ft. and 9 ft. rakes respectively, and 2537 having a jointed mechanism. These machines have a forked steel frame bent at the rear end which is carried on a swivel which, with a neat adjustment provision similar to that adopted in the Ridge and Furrow Swath Turners by the same makers, readily admits of the height being altered, the fore end of the frame being attached by bearing brackets to the main axle carried by the driving wheels.

The motion is very much the same as in the Swath Turner, being imparted to four rakes running the whole width of the implements by gearing, which, acting on a disc, gives an eccentric motion. The rakes, which are at right angles to the line of travel, consist of a number of spring teeth which come into action in rotation, and move the crop bodily to the side of the machine in windrow. The height of the fore end of the frame can be adjusted by a lever under the control of the driver.

In Messrs. Martin's third machine, No. 2537, the raking mechanism is constructed in sections and supported by an extra trailing wheel, with a view to adapting the machine to ridge and furrow work. This machine has a working width of 8 feet.

Messrs. Blackstone's machine, No. 3679, may perhaps be described as an elongated adaptation of their Swath Turner.

The principle of the frame work and driving gear is very much the same as in the Swath Turner, but the independently pivoted tines are carried by a chain running over a sprocket wheel attached to the turning head, a second chain, with a series of loops, being introduced, the tines being passed through these loops, and the chain being worked by a geared sprocket wheel. The two chains are driven at the same speed, each pair of wheels over which the chains work, being at a uniform height from the ground, the first chain working at an angle slightly out of the horizontal, and the second in a vertical position. When in motion the teeth can be made to travel

transversely, carrying the material to be collected with them, each tooth as it reaches the limit of its transverse movement in one direction being lifted from the ground and caused to travel in the reverse direction, the stirrups on the lower side of the vertical chain holding the teeth whilst collecting, and those on the upper side guiding the teeth in the opposite direction.



FIG. 3.—Blackstone's Side Delivery Rake, No. 3679.

The lay shafts through the medium of which motion is transmitted to the sprocket wheels carrying the chains, are driven by right and left spur gearing, which, by means of two sliding clutches on the extension pieces of a counter shaft, are indirectly acted on by a foot lever, capable of being worked from the seat. This lever is connected to a rod, the forks of which engage with the clutches mentioned. By placing this lever in a central position the gearing is put out of motion and an ordinary fixed rake is obtained. By moving the lever sideways one or other of the clutches engage, and motion is imparted to the chains, and from them to the teeth.

Messrs. Martin's 9 ft. machine was not brought out for trial.

Of the three machines tried Messrs. Martin's perhaps, on the whole, gathered the crop up best, but the same tendency to roll the crop as in the Swath Turners was very noticeable, and is undoubtedly a serious drawback. The draft of these machines is light and the mechanism simple.

The following two illustrations, which appeared in *The Implement and Machinery Review*, and the plates of which have been kindly lent by the publisher, Mr. Harry Westcott, illustrate very clearly the difference in the work done by the machines belonging to the different makers, and the rolling or roping of the crop by Messrs. Martin's implement (to which the Judges took such exception) not only by the Side Delivery Rakes, but also by the Swath Turners exhibited by the same makers.



FIG. 4.—Blackstone's Side Delivery Rake making a Wagon-row.





FIG. 5. Martin's Side Delivery Rake making a Wagon-row.

Messrs. Blackstone's machine failed to clean the ground really satisfactorily at first, but when adjusted did excellent work. This machine also had the advantage of being able to deliver the crop to either side. The draft was undoubtedly heavier than that of the other exhibits. As regards work it certainly satisfied the Judges, and was given first prize, the second prize going to Messrs. Martin's No. 2535. This brought the trials in connection with Classes 1 and 2 to an end.

Mr. Ball and I are very grateful for the excellent arrangements made by Mr. Courtney and the kind assistance given by him and the Stewards of Implements, Messrs. Greaves and Pilkington. We should also like to add our sincere thanks to Mr. Scorer for all his kind hospitality, and for the interest he took in the trials. His valuable co-operation with the officials of R.A.S.E. was of the greatest help, and went far to ensure the trials being of a practical and fair character. All connected with the trials appreciated Mr. Scorer's kindness, which fully made up for any want of courtesy on the part of the Clerk of the Weather.

FRANCIS E. WALKER.

Swansfield House, Alnwick.

## MISCELLANEOUS IMPLEMENTS EXHIBITED AT LINCOLN, 1907.

THE number of exhibits in the Implement classes this year showed a slight decrease compared with last year's Show at Derby, the number being 4,726 as against 4,772 last year. There was also a decrease in the number of Miscellaneous Implements competing for the Society's Silver Medal, 46 such implements being entered, compared with 56 in 1906.

Only one Silver Medal was recommended by the Judges, and this was awarded to Mr. F. M. Dossor, for Article No. 399.

Article 399.—*Mr. F. M. Dossor*, 15 Auckland Road, Doncaster. "Seed Dresser, for hand or power driving. A machine for cleaning clover and other small seeds by the extraction therefrom of docks, dodder, and other weeds, light seeds, and other foreign matter." Price 61*l*.

The principle of this machine is quite new, the processes of sieving and blowing hitherto in general use being entirely dispensed with. The Dresser is built in sections, each section being provided with a combined receiving and distributing hopper, which also acts as a cover to the running belt, and is fitted with a velvet curtain. The cleaning of the seed is effected by its being distributed over this series of sections, running at the same speed and driven by chain wheels. The seed is received, checked, and passed on from section to section, the belt in each case acting independently upon it. All substances on which, owing to irregularity of shape, light weight, rough skin, or other causes, the belts are able to obtain a lifting grip, are held by the nap of the velvet of the sections and are thrown out at the back of the machine, while good seed continues its passage down the machine, and is discharged at the front. By means of an adjustment at the back, the angle of the machine can be altered, and the speed regulated, according to the foulness of the seed and the degree of cleanliness required. The capacity of the dresser depends, of course, upon the condition of the seed being treated and the degree of purity desired, but may be estimated at from 15 to 20 cwt. per day of nine hours. By means of this adjustment almost any degree of purity can be obtained, and it is claimed that seeds dressed on this machine can be guaranteed free from docks, and that the appearance of the seed is brightened and improved by frequent contact with the belts. The dresser exhibited at Lincoln stands seven feet nine inches high, and occupies some four feet square of floor space, and can be worked by one man or by light motive power. The work accomplished in cleaning seeds was excellent, and,

in the opinion of the Judges, this machine would be a great advantage to farmers who grow clover for seed, as the passage of the seed through a dresser of this description must lead to its commanding a much higher price, and the work is thoroughly done at much less cost than is usual with other methods.

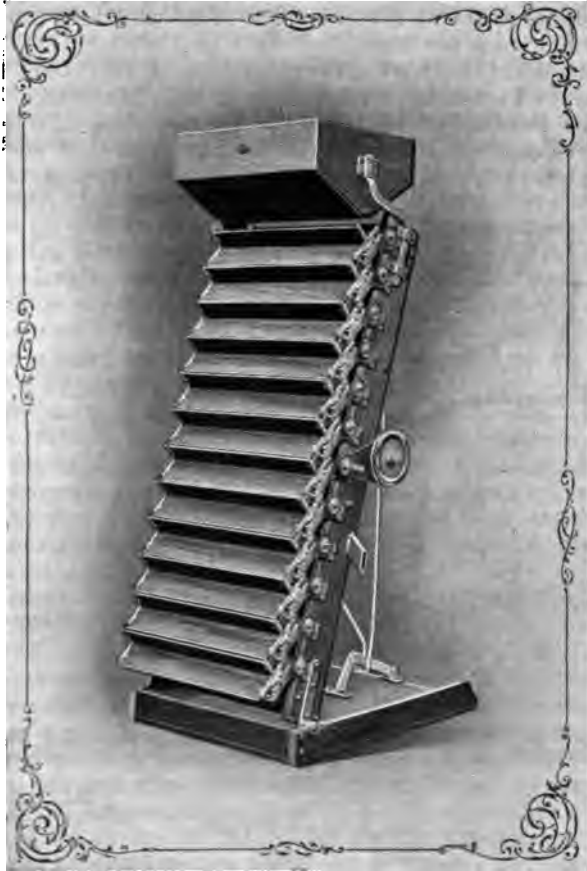
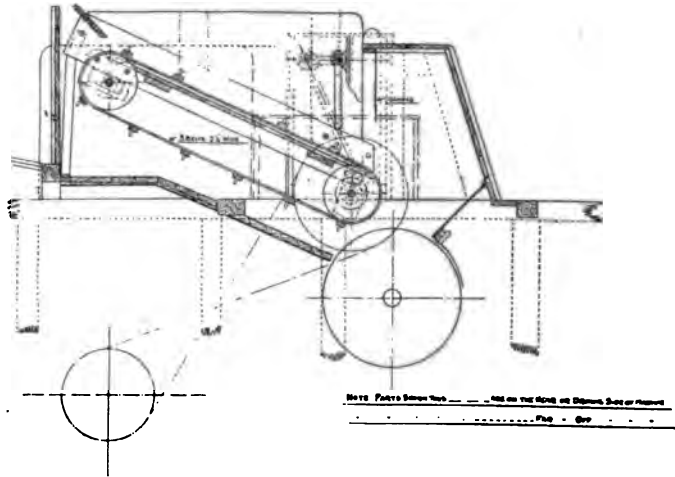

FIG. 1.—Seed Dresser.

Article 712.—*Mr. Thomas Page*, Bottesford, Nottingham. “Steel wire fence, electrically welded, manufactured by the Pittsburgh Steel Company.”—The electrically welded joints of this fence are a distinct feature, and are at once neat and strong. There is no wrapping or clamping, and the welded joints show no exposed ends or wraps to hold snow or moisture

and cause rust. The joints are exceedingly strong, as the wire is not weakened nor the galvanising injured by twisting round the lateral wires. The tension curves midway between the stay wires make ample provision for expansion and contraction, and adapt the fencing for fixing over uneven ground. The materials used in the construction of this fencing are good, and the workmanship and galvanising are also of a high standard, while the price is not high.

Article 1528.—*Messrs. Marshall Sons & Co., Ltd., Gainsborough.*—“Threshing Machine fitted with Marshall’s Patent Conveyor Feeder.”—The conveyor feeder, shown in Fig. 2, is an arrangement consisting of a rake conveyor revolving round pulleys keyed on spindles at each end, and working



ARR<sup>Y</sup> OF SPECIAL TYPE OF CONVEYOR-FEEDER FOR A.2. MAC.

MES 2116.

SCALE 1/2" = 1 FOOT

FIG. 167<sup>th</sup> 1907 1097<sup>th</sup>

FIG. 2. Conveyor Feeder.

in an inclined position. The lower end revolves as near as possible to the drum of the machine, whilst the upper end can be fixed at a convenient height to suit the requirements of the work. This arrangement of feeder reduces the manual labour necessary for feeding purposes, one man only being required on the top of the thresher to cut the bands and drop the loose sheaves on to the conveyor feeder. The sheaves are then conveyed to the mouth of the drum, where they come into contact with a line of oscillating forks, and are spread out

evenly before entering the threshing drum. These oscillating forks are readily adjustable to suit various descriptions of grain. By the use of this machine greater regularity is ensured in the distribution of the grain to the drum, and enables the work to be done at a higher speed, while the machine meets all requirements of a drum guard as a prevention against accidents. As will be seen from the diagram, the arrangement is simple, and the conveyor feeder is worked with considerably less gearing than most types of feeder, lessening the weight of the machine, and reducing the cost of repairs and upkeep. The extra cost of a conveyor feeder, fitted to a threshing machine, is 15*l*.

Articles 3845-6. — *Vacca, Ltd.*, 7 Denman Street, S.E. "Milking Machines, manufactured by Messrs. Lawrence and Kennedy, of Glasgow, 'L. K. G.,' suitable for horse gear, steam, gas, or oil engine, or electric motor."—The structural improvements in these machines entitle them to be considered as "New Implements," and the inventors claim that all the objections present in the earlier milking machines are now surmounted. The machine consists of a small portable pulsator, which is fixed on the milk pail, and connected to the teats of the cow by cups at the end of flexible tubes. By another flexible connection the pail communicates with a vacuum pipe, and an air exhaust, by which the pulsators are actuated. In the machine exhibited the pulsating parts are simplified, and there are numerous improvements in design; the vacuum is utilised for the threefold purpose of holding the cups on the teats, producing suction, and operating the mechanism giving the compressing movement.

Article 4712.—*The Hartnett Patent Milking Machine Co., Ltd.*, 20 High Holborn, W.C. "Milking Machine, Hartnett's Patent." Price, exclusive of motor power, 38*l*.—The Hartnett machine works by means of a double vacuum, combining the compression of the teats and the suction for drawing away the milk. A peculiar and ingenious feature of the apparatus is that the cups automatically release themselves when the animal has ceased to give milk. This is effected by the destruction of the vacuum, brought about by the apparatus. Another point in the favour of this machine is that the pulsator, instead of being attached to the milk can, is fixed over head, out of reach of the animals.

It was impossible for the Judges, in the short time at their disposal, to express any practical opinion upon these milking machines, as this would necessitate a most exhaustive trial, to ascertain whether, in their present state, they could be recommended for use in large dairies. There is, however, no doubt that if the milking machine is found to be practicable, it will solve one of the great difficulties of the present time, which

has arisen owing to the limited number of milkers now obtainable, and will also deal with the problem of the complete purification of milk. The process of milking by machine is certainly far more cleanly and hygienic than hand milking, and it is also claimed that recent improvements in the design of the machines have entirely prevented the possibility of injury to the cows. It is asserted that neither the quantity nor the quality of the milk yield is injuriously affected, and that the milking is thorough, while the cost of labour is reduced some 50 per cent. The cost of maintaining the machines in repair is said to be slight.

Article 3877.—*Messrs. A. Ransome & Co., Ltd., Newark-on-Trent.* “Horizontal Log Band Saw (Ransome and Lavos Patent, with direct electric drive).” Price 700*l.*—The machine exhibited, size OA (Fig. 3), will deal with logs up to 48 inches in diameter. It is driven by a 50 horse-power electric motor,

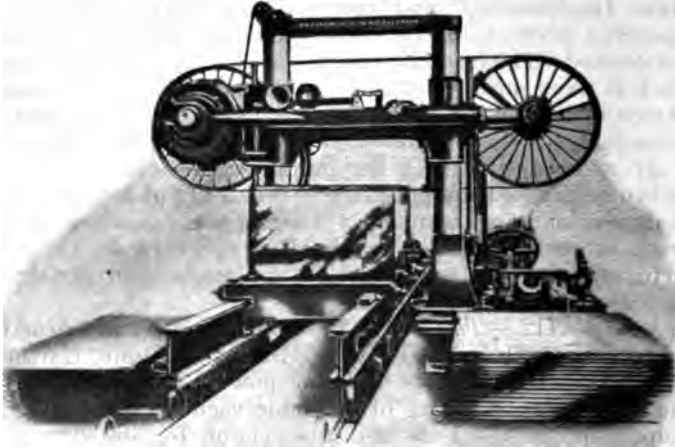

FIG. 3.—Horizontal Log Band Saw.

and the feed and elevating gear is actuated by a second 12 horse-power motor. The saw is 5½ in. wide, by No. 18 gauge, and the teeth are 1½ in. pitch, the pulleys being 5 ft. in diameter. For forest use, one of the great advantages of these saws is that they are entirely above ground, and only a small concrete foundation is required. The saw blade runs at a speed of 7,000 ft. a minute, and the saw pulleys are fitted on turned steel shafts running in ball bearings. By the movement of a weight on a horizontal lever the tension of the blade is varied to suit saws of different gauges. The feed ranges from 4 to 80 ft. a minute, and is controlled by a switch handle, by which the advance of the log can be instantaneously regulated.

Another lever controls the backward motion of the carriage, which is 250 ft. a minute, and both movements are driven by an arrangement of friction gear. The carriage moves by means of two wrought steel pinions with machine cut teeth working into corresponding racks under each main side girder. The rate of cutting is exceptionally high, as much as 100 superficial feet of elm being dealt with in a minute, and the even running of the saw and the firmness with which the log is held allow an exceptional smoothness of cut. The saws are thinner than those used in vertical log frames, and thus the waste of wood is slight, while the simplicity of control effects economy of labour.

Article 4124.—*The Lamp Pump Syndicate, Ltd.*, 12, Carey Street, Westminster, S.W. "Pump manufactured by the Pulsometer Engineering Company, automatic vacuum lift and force for farm and other purposes, with lamp and boiler complete." Price 35*l.*—This machine is direct driven by a single-acting condensing engine, and for lifts of less than 50 ft. it is worked by vacuum only, produced by condensing steam at atmospheric pressure; for lifts exceeding 50 ft. the power of the pump may be increased by using steam above atmospheric pressure. Steam is supplied by a small boiler heated by an ordinary paraffin furnace lamp. The construction of the apparatus is shown by the sectional elevation (Fig. 4). The engine, main pump, and air pump are of gunmetal throughout, the body of the condenser is of cast iron, and the condensing surface is provided by the suction pipe of the pump which passes through the body of the condenser. The upper end of the piston rod is provided with a T handle, and as soon as the water in the boiler reaches a temperature of 212° the pump is started by hand for a few strokes until a vacuum is formed, when the action of the machine is entirely automatic. The diagram shows the piston at the bottom of the stroke, and the control valve (A) is in such a position that steam enters through the port (B) and passes through the pipe (D) to the under side of the piston. The upper side of the piston is under vacuum, being in communication with the condenser (F) through the port (C) and the pipe (K), and the piston commences its up stroke. The valve (A) is held in position by vacuum on the under side of the working piston at its lower end, this side being in communication through the pipe (E) with the upper end of the engine cylinder, which has already been shown to be open to the condenser. When the main piston reaches the top of its stroke, it opens the pipe (E) to the steam on its under side, and the vacuum below the working piston of the valve (A) is destroyed, and as the upper end of the valve is open to the condenser the valve rises, closing the steam port (B), cutting

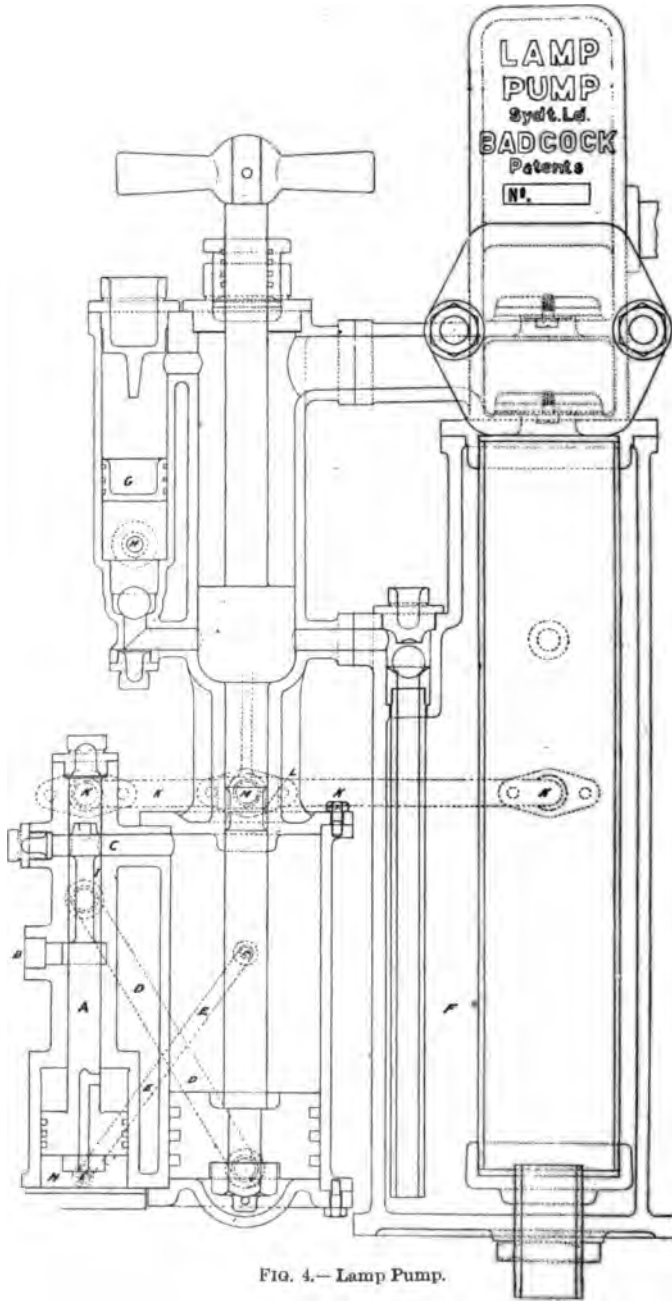

FIG. 4.— Lamp Pump.



off communication through the port (C), the valve port (I) in the control valve, and the pipe (D). The piston is thus in equilibrium and commences to descend, partly by its own weight, and partly by the vacuum on the under side of the pump plunger, which also acts as the piston of the air pump. During the down stroke the steam that was below the main piston is displaced and passes through the pipe (D) and the port (C) to the upper end of the cylinder at its original volume. This still maintains the control valve (A) at the top of its stroke until the portway (L) in the main piston rod opens a port in the cylinder cover (not shown in the drawing) which communicates with the condenser through the port (M) and the pipe (K). The result is that there is again a vacuum on the top side of the piston which, through the pipe (E) again draws the control valve (A) to the position shown on the drawing, and steam is again admitted for the next stroke. The action of the main pump and the air pump are clearly shown on the drawing; the small free piston (G) drives out the products of condensation through the check valve (H). It is controlled by the action of the water in the pump barrel. A trial was made of the two pumps exhibited, but owing to slight mechanical defects of construction, the results were not so satisfactory as might have been expected; these will most probably be eliminated in future pumps. There is no doubt a demand for a handy pump for small supplies, and the Lamp Pump would appear to be likely to meet this demand.

The best thanks of my colleague, Mr. James Younger, and myself are due to the Stewards of Implements, Mr. R. M. Greaves and Mr. Claude M. S. Pilkington, and to the Society's Consulting Engineer, Mr. F. S. Courtney, for the valuable assistance they afforded us.

THOMAS STIRTON.

Rendlesham Estates Office,  
Woodbridge, Suffolk.

---

## MILK AND BUTTER TESTS AT THE LINCOLN SHOW, 1907.

### I.—MILK YIELD TESTS.

THE amount of money awarded to these classes was augmented this year by an extra prize given to the Lincolnshire Red Short-horns, but in all other respects the prizes were similar to those given last year at Derby, the conditions and methods adopted for carrying out the trials being the same.

The scale of points governing these competitions was as follows :—

One Point for every 1 lb. of milk.

One Point for every completed ten days since calving, deducting the first forty days. Maximum points for lactation 12.

Four points for every one per cent. of fat shown on the average of the two milkings.

Cows whose milk shows less than an average of 3 per cent. of fat on the two milkings will be disqualified.

Fractions of lbs. of milk, percentage of fat, and incomplete periods of less than ten days to be worked out in decimals, and added to the total points.

No Prize or Commendation to be awarded to cattle which do not obtain the following points :—

	Cows 5 years old and over	Cows and heifers under 5 years of age
Shorthorn, Lincolnshire Red Short-horn, South Devon, Red-Polled, Ayrshire, Jersey, Guernsey, or Longhorn .	55	50
Kerry or Dexter	40	35

In the case of cows obtaining the same number of points, the Prize to be awarded to the cow which has been the longest time in milk.

Highly Commended Cards will be awarded to all animals other than winners of the Prizes which reach the above standard.

The cattle were stripped on Tuesday evening, June 25th, at 5 p.m., the milk of the next twenty-four hours being taken for the trials. Both the morning and evening milks, after being weighed, were sampled by Dr. Voelcker for analysis.

The full results of the trials in the milk yield classes will be found in Table I. on pp. 139 and 140, while Table II., page 141, gives the particulars in the special class, which being open to all breeds plays the part of a champion class.

The next table, No. III., gives the number of cattle of each breed competing, and for the purposes of comparison the numbers for 1905 and 1906 are also given.

TABLE I.—MILK-YIELD CLASSES AT LINCOLN, 1907.

No. in Catalogue	Exhibitor	Name of cow	Date of birth	Date of last calf	No. of days in milk	Total milk yield in 24 hours	Fat per cent- age	Points			Awards	
								Fat per cent- by 4	Lacta- tion	Total		
<b>Class 87</b>												
820	C. R. W. Adeane	<i>Shorthorns</i> Baobaham Darling Lady	Feb. 24, 1902	1907 Apr. 9	59	40 12	275	36.75	11.00	130	4945	Below Fat Standard.
828	C. R. W. Adeane	Ingram's Rose	Apr. 16, 1899	Apr. 11	76	41 12	342	41.92	15.88	340	6040	R.H.C.
829	C. R. W. Adeane	Priceless Princess	Feb. 10, 1902	June 9	17	53 16	370	55.37	14.80	N11	7017	3rd Prize, 4i.
831	H. Hunter	May Duchess	May 2, 1901	May 21	36	58 10	305	58.62	12.20	N11	7083	2nd Prize, 6i.
832	Lord Rothschild	Dorothy	July 15, 1901	Apr. 3	84	62 2	288	63.12	11.40	440	7792	Below Fat Standard.
834	Lord Rothschild	Warwickshire Hettie	Apr. 25, 1899	Apr. 21	31	66	310	59.12	12.40	240	7412	1st Prize, 10i.
835	R. Shelton	Mercote Lavender Princess	Dec. 21, 1899	May 31	26	57 2	293	57.37	11.88	N11	6905	Below Fat Standard.
838	G. W. Tysler	Lady Lee 21st	Jan. 1, 1902	Apr. 23	64	40 9	272	40.12	10.88	240	5340	Below Fat Standard.
846	R. Shelton	Alstoe Beauty	Feb. 11, 1903	June 9	17	30 12	342	30.75	13.68	N11	4443	
<b>Class 109</b>												
1888	J. Evens	<i>Lincolnshire Reds</i> Burton Vic 2nd.	Aug. 27, 1898	Mar. 21	97	63 2	377	63.12	15.08	570	8390	1st Prize, 10i., & 1st Prize S.C., & 20i.
885	J. Evens	Burton Scarlet	1902	May 15	—	—	—	—	—	—	—	Withdrawn.
1845	Miss K. Carleton	Burton Young Cherry	Nov. 18, 1899	May 28	29	56 6	372	56.37	14.88	N11	7125	3rd Prize, 4i.
1846	J. Evens	Burton Cork 3rd	Aug. 24, 1900	Apr. 8	70	47 0	342	47.00	13.88	340	6458	R.H.C.
1847	J. Evens	Burton Studley 5th	Oct. 2, 1901	May 6	52	51 0	275	51.00	11.00	130	6320	Below Fat Standard.
1848	J. Evens	Burton Spout 5th.	Mar. 23, 1903	Apr. 20	67	40 12	332	46.75	13.28	270	5673	H.C.
1849	J. Evens	Burton Vetch 1st	Feb. 1, 1900	Apr. 4	53	56 8	382	56.50	15.28	130	7308	2nd Prize, 6i.
1860	F. Scorer	Bracebridge 19th	Mar. 31, 1900	Feb. 10	136	39 2	295	39.12	11.80	940	6052	Below Fat Standard.
1851	F. Scorer	Bracebridge 17th	Aug. 13, 1900	May 11	46	54 10	307	54.62	12.28	60	6750	4th Prize, 3i.
<b>Class 122</b>												
11068	W. P. Vosper	Honesty 3rd	Nov. 7, 1898	Mar. 5	113	57 0	412	57.00	16.48	730	8078	1st Prize, 10i., & 2nd Prize S.C., & 10i.
<b>Class 138</b>												
11073	J. S. Worth	Noesney 4th	Jan. 4, 1900	Feb. 4	142	36 8	420	36.50	10.80	1020	6350	2nd Prize, 6i.
<b>Class 138</b>												
11145	T. Brown & Son	Frill	Oct. 8, 1901	Mar. 20	98	30 0	235	30.00	9.40	580	4520	Below Fat Standard.
11145	Sir W. Corbett Bart.	Desires of Johnstown	Dec. 26, 1900	Apr. 23	64	14 14	375	44.87	15.00	240	6237	2nd Prize, 6i.
11152	Lord Rothschild	Clarissa	Dec. 31, 1898	Apr. 27	60	12	302	51.75	12.08	200	6583	1st Prize, 10i.
11152	Lord Rothschild	Coronet 3rd	Feb. 21, 1899	Mar. 9	109	37 14	357	37.87	14.28	690	5915	R.H.C.
11155	Lord Rothschild	Roseway Lady	Mar. 22, 1899	Mar. 11	107	39 8	365	39.50	14.60	670	6080	3rd Prize, 4i.
11155	G. Dudley Smith	Lollypop	Jan. 6, 1900	Apr. 15	72	35 6	290	35.37	11.60	320	5017	Below Fat Standard.
<b>Class 155</b>												
1284	J. Howie	Lady Flora	Mar. 14, 1898	Feb. 14	132	44 0	370	44.00	14.80	920	6800	1st Prize, 10i.
1287	J. Howie	Nannie 7th of Orcharion	Feb. 12, 1897	Mar. 2	116	38 14	365	38.87	14.60	760	6107	2nd Prize, 6i.
1288	Messrs. Kerr.	Old Graintney Queen 2nd	Sept. 1903	June 10	16	40 6	397	40.37	15.88	N11	5625	3rd Prize, 4i.
1288	A. Mitchell	Lady Douglas	May 25, 1901	June 1	25	41 14	335	41.87	13.40	N11	5527	R.H.C.

1 These animals were also entered for the Special Milk-yield Competition (Class 184), see Table II., page 141.

2 S.C.=Special Class.

TABLE I.—MILK-YIELD CLASSES AT LINCOLN, 1907—continued.

No. in Catalogue	Exhibitor	Name of cow	Date of birth	Date of last calf	No. of days in milk	Total milk yield in 24 hours	Fat per cent. age	Points			Awards	
								Milk	Fat per cent. by 4	Lactation Total		
<b>Class 163</b>												
1314	T. Beeby	Phyllis	Feb. 27, 1898	1907	150	29 10	5.52	29.92	22.08	11.00	62.70	3rd Prize, 4l. 1st Prize, 10l. Below Fat Standard. R.H.C. Withdrawn. 2nd Prize, 6l. 1st Prize, 10l. — — 3rd Prize, 4l. 1st Prize, 10l. 2nd Prize, 6l.
1319	Ladies E. & D. Hope	Golden Rush	Mar. 21, 1899	Jan. 27	92	37 8	5.35	37.50	21.40	5.20	64.10	
1325	A. Miller-Ballett.	Vanilla 2nd.	Apr. 15, 1900	Mar. 30	88	48 8	4.75	48.50	11.80	4.80	65.10	
1328	Earl of Rosebery	Welsh Lady	Jan. 18, 1900	Mar. 14	104	36 12	4.27	36.75	17.08	6.40	60.23	
1333	Mrs. Spencer	Portia	Apr. 6, 1902	Jan. 23	152	34 4	4.42	34.25	17.68	11.20	63.13	
<b>Class 169</b>												
1369	Sir H. Lennard, Bart.	Wickham Fancy	July 1, 1903	Jan. 13	164	37 12	4.45	37.75	17.80	12.00	67.55	2nd Prize, 6l. 1st Prize, 10l. — — 3rd Prize, 4l. 1st Prize, 10l. 2nd Prize, 6l.
1403	H. F. Plumptre	Melanie of Goodnestone	Sept. 27, 1900	Jan. 16	161	38 0	4.92	38.00	18.48	12.00	68.48	
404	H. F. Plumptre	Muriel 12th.	Apr. 16, 1901	Apr. 20	67	33 6	3.92	33.37	15.68	3.70	51.75	
1415	J. I. Smail	Cleopatra of Goodnestone	Mar. 20, 1902	May 6	51	24 12	4.30	24.75	17.20	1.70	43.05	
1408	Lady Titchborne.	Itchen Carnation	Oct. 21, 1903	Mar. 29	89	37 8	5.27	27.50	21.08	4.90	53.48	
<b>Class 174</b>												
1437	W. H. Sale	Lady Panza	Sept. 8, 1902	May 11	46	44 8	4.25	44.50	17.00	.60	62.10	1st Prize, 10l. 2nd Prize, 6l.
1439	C. T. Scott	Taverner's Dark Pansy	Apr. 19, 1898	June 6	20	41 4	3.45	41.25	13.80	Nil	55.05	
<b>Class 178</b>												
1462	Lady Greenall	Aicme Cold.	March, 1896	May 8	49	42 8	4.02	42.50	16.08	.90	59.48	1st Prize, 10l. 2nd Prize, 6l. Below Fat Standard. 3rd Prize, 4l. R.H.C.
1454	Duchess of Newcastle	Hardwick Pearl	May 10, 1902	May 8	49	38 0	3.87	38.00	15.48	.90	54.38	
1456	Duchess of Newcastle	Ivy 7th of Carlton	Feb. 20, 1900	Apr. 30	57	34 12	2.90	34.75	11.00	1.70	46.05	
1458	G. L. Palmer	Mollie Dhubb	May 25, 1898	Apr. 16	71	34 4	3.72	34.25	14.88	3.10	52.23	
1457	E. Royds	Gaythorpe Cockhorn	1902	Feb. 22	124	27 12	3.90	27.75	14.40	8.40	50.55	
<b>Class 183</b>												
1462	G. J. B. Chetwynd	Don Galeandra.	1901	May 26	31	41 6	3.87	41.37	15.48	Nil	56.85	3rd Prize, 4l. H.C. H.C. H.C. 1st Prize, 10l. R.H.C.
1464	B. de Bertodano.	Cowbridge Sunny Lass	July 11, 1902	Apr. 27	60	25 8	3.87	25.50	15.48	2.00	42.98	
1486	B. de Bertodano.	La Mancha Beatrice	March, 1898	Feb. 8	138	20 8	3.22	20.37	12.88	9.80	43.05	
1486	B. de Bertodano.	La Mancha Sweet Nell	1901	Jan. 25	152	36 14	3.50	36.87	14.00	11.20	62.07	
1488	Duchess of Devonshire.	Compton Dazzle.	1900	Feb. 1	176	34 4	4.03	34.00	15.04	7.40	63.44	

No in Catalog

Exhibitor	Name of cow	Breed	Date of birth	Date of last calf	No. of days in 24 hours	Total milk 5% Fat percent	Milk	Fat cont. by cent.	Lactation	Total	Awards
831 T. Hunter	May Duchess	Shorthorn	May 2, 1901	1907	36	58 10	58.62	12.20	Nil	70.82	H.C.
832 Lord Rothschild	Dorothy	Shorthorn	Apr. 25, 1901	May 21	66	58 10	62.12	11.40	4.40	77.92	Below Fat Standard
834 Lord Rothschild	Warwickshire Hetty	Shorthorn	July 15, 1899	Apr. 21	68	56 7	59.12	12.40	2.60	74.12	H.C.
836 J. Shelton	Mervone Lavender Princess	Shorthorn	Dec. 21, 1895	May 31	29	57 9	57.37	11.08	Nil	69.05	Below Fat Standard
868 J. Evens	Burton Vic 2nd	Lincoln Red	Aug. 27, 1898	Mar. 21	37	63 2	63.22	13.08	3.70	85.90	1st Prize, 30l.
945 J. Es. K. Chricton	Burton Young Cherry	Lincoln Red	Nov. 18, 1899	May 28	28	46 6	46.57	14.88	Nil	71.25	H.C.
946 J. Evens	Burton Cork 3rd	Lincoln Red	Aug. 24, 1900	Apr. 8	12	47 0	47.00	11.88	3.90	64.38	Below Fat Standard
947 J. Evens	Burton Ruddy 5th	Lincoln Red	Oct. 3, 1901	May 5	18	47 0	47.00	11.88	2.20	68.20	H.C.
948 J. Evens	Burton Violet	Lincoln Red	Mar. 22, 1903	Apr. 20	67	56 9	56.92	13.28	7.70	76.73	H.C.
949 F. Scorer	Burton Spot 5th	Lincoln Red	Mar. 31, 1900	May 4	53	46 8	46.82	12.28	1.30	60.38	H.C.
951 F. Scorer	Bracebridge 11th	Lincoln Red	Aug. 12, 1900	Feb. 10	139	59 9	59.92	12.28	9.60	87.52	Below Fat Standard
1068 W. Cooper	Honesley 3rd	Swth Devon	Nov. 7, 1898	Mar. 5	46	54 10	54.12	12.28	7.00	81.70	H.C.
1073 J. S. W. Roth	Nosegay 4th	Red Polled	Jan. 26, 1900	Feb. 4	112	57 8	57.82	16.48	7.30	83.70	H.C.
1123 Sir W. Corbet, Bart.	Despree of Johnstown	Red Polled	Dec. 21, 1898	Apr. 25	64	44 11	44.12	16.80	10.20	65.20	H.C.
1124 Lord Rothschild	Charrissa	Red Polled	Dec. 5, 1898	Apr. 27	72	55 10	55.12	17.08	2.40	65.82	H.C.
1125 G. Dudley Smith	Lady Joseph	Red Polled	Jan. 27, 1900	Jan. 27	75	55 10	55.12	17.08	3.20	60.17	H.C.
1314 F. Booth	Phyllis Daisy	Jersey	Mar. 14, 1898	Jan. 27	139	57 12	57.12	22.08	11.00	89.70	Below Fat Standard
1315 R. H. Cobb	Golden Rush	Jersey	Mar. 15, 1899	Feb. 26	139	57 12	57.12	22.08	9.80	85.85	H.C.
1316 L. G. R. & D. Hope	Golden Rush	Jersey	Mar. 15, 1899	Feb. 26	82	57 8	57.82	21.40	5.20	84.10	H.C.
1325 A. Miller-Hall	Portia	Jersey	Apr. 16, 1900	Mar. 30	82	57 8	57.82	21.40	4.80	65.10	Below Fat Standard
1327 Mrs. Matilda Spencer	Portia	Jersey	Apr. 16, 1900	Mar. 30	154	46 8	46.82	11.80	Nil	65.10	Withdrawn
1447 F. Hovels	Lady Panza	Kerry	Sept. 8, 1902	May 11	44	8	4.25	17.00	60	62.10	H.C.
1457 F. Hovels	Casthorpe Cuckhorn	Kerry	Feb. 22, 1902	Feb. 22	121	12	12.00	14.40	8.40	56.55	H.C.
1522 G. Barry	Tiny's Daisy	Jersey	May 13, 1903	May 13	44	57 4	57.42	14.80	40	72.42	H.C.
1523 G. Barry	Deborah	Cross bred	Jan. 1901	Mar. 25	162	51 10	51.12	14.80	6.20	72.42	H.C.
1524 J. Evens	Burton Daisy	Shorthorn	1899	May 25	92	67 4	67.42	12.00	Nil	69.52	H.C.
1525 J. Evens	Burton Daisy	Shorthorn	1899	June 25	34	65 4	65.42	13.68	Nil	78.92	3rd Prize, 5l.
1526 D. Kelly	Fortuna	Shorthorn	Unknown	Feb. 25	68	53 10	53.12	15.40	5.90	74.32	R. H.C.
1527 C. & M. Palmer	Virtue	Jersey	Mar. 29, 1897	Feb. 6	140	24 14	24.14	19.60	10.40	54.47	H.C.
1528 C. & M. Palmer	Buttercup	Jersey	Nov. 5, 1900	Mar. 14	104	42 4	42.42	18.80	6.40	67.25	H.C.
1530 J. A. Williams	Buttercup	Guernsey	1902	Mar. 1	117	40 10	40.12	14.80	7.70	63.12	H.C.

Animals entered in the Milk-yield Classes of the various Dairy Breeds were also eligible for entry in Class 184. For the awards to such animals, see Table I, on pp. 139 and 140.  
The 1st and 2nd prizes in Class 184 were awarded to No. 888 in Class 102, and No. 1068 in Class 121.

TABLE III.

Breed	Park Royal, 1905	Derby, 1906	Lincoln, 1907
Shorthorns	18	10	12
Lincolnshire Red Short-horns	5	4	8
South Devons	2	2	2
Red Polled	8	6	6
Ayrshires	5	1	4
Jerseys	29	18	9
Guernseys	9	8	6
Longhorns	2	1	2
Kerries	11	5	5
Dexters	8	8	10
Crossbred	—	—	1
Total	89	63	65

Following the lines of last year's report, the averages of the milk yields have been worked out separately for each breed, from the restricted or breed milk-yield classes, while the averages of the cows entered in the special class have been kept distinct, the object being to show (a) the capacity for milk production on the most profitable lines peculiar to each breed, and (b) that with specially selected cows a higher average may be attained.

Unfortunately, in the case of the Lincolnshire Red Short-horn and the South Devon Cattle, the same animals were entered in the special class, so nothing can be learnt from their figures in Table II.

There being only one entry of a crossbred cow, I have omitted the particulars relating to her, since the information derived therefrom is of little or no value to breeders of pedigree stock.

TABLE IV.—*Averages of Cattle entered in the Breed Milk-yield Classes.*

No. of cows competing	Breed	Days in milk	Milk	Fat per cent.	Points			
					Milk	Fat	Lactation	Total
			Lb. oz.					
9	Shorthorns	49	49 1½	3·16	49·10	12·64	0·90	62·64
8	Lincoln. Red do.	69	51 1	3·35	51·06	13·40	2·90	67·36
2	South Devons	127	46 12	4·16	46·75	16·64	8·70	72·09
6	Red Polled	85	39 14½	3·20	39·89	12·80	4·50	57·19
4	Ayrshires	72	41 4½	3·67	41·28	14·68	3·20	59·16
5	Jerseys	117	37 5½	4·50	37·37	18·00	7·70	62·07
5	Guernseys	106	32 4½	4·51	32·27	18·04	6·60	56·91
2	Longhorns	33	42 14	3·85	42·87	15·40	—	58·27
5	Kerries	70	35 4	3·42	35·25	13·68	3·00	51·93
10	Dexters	84	31 2½	3·35	31·13	13·40	4·40	48·93

TABLE V.—Averages of Cattle entered in the Special Milk-yield Class.

No of cows competing	Breed	Days in milk	Milk	Fat per cent.	Points			
					Milk	Fat	Lactation	Total
7	Shorthorns	51	Lb. oz. 59 1	3·17	59·06	12·68	1·10	72·84
8	Lincoln. Red do.	69	51 1	3·35	51·06	13·40	2·90	67·36
2	South Devons	127	46 12	4·16	46·75	16·64	8·70	72·09
3	Red Polled	65	44 0	3·23	44·00	12·92	2·50	59·42
1	Longhorns	46	44 8	4·25	44·50	17·00	0·60	62·10
7	Jerseys	108	38 4	4·62	38·25	18·48	6·80	63·53
1	Guernseys	117	40 10	3·70	40·62	14·80	7·70	63·12
1	Kerries	124	27 12	3·60	27·75	14·40	8·40	50·55

I regret to have to report that twelve cows gave milk which showed less than an average of 3 per cent. of fat on the two milkings, and consequently they were disqualified. The particulars are as follows:—

4	Shorthorns	out of an entry of 9
2	Lincolnshire Red Short-horns	" 8
2	Red Polled	" 6
1	Jersey	" 7
1	Kerry	" 5
2	Dexters	" 10

## II.—BUTTER TESTS (CLASS 185, A & B).

The number of cattle competing in these classes shows an improvement on last year's entries, 35 animals being present against 25 last year at Derby, the numbers being the same as at Park Royal in 1905.

The prizes given at Lincoln were of the same value as last year. The scale of points under which these trials were carried out were as follows:—

One point for every ounce of butter.

One point for every completed ten days since calving, deducting the first forty days. Maximum allowance for period of lactation, 12 points.

Fractions of ounces of butter and incomplete periods of less than ten days to be worked out in decimals and added to the total points.

No Prize or Commendation to be given to Cows under five years old failing to obtain 28 points (or in the case of Jerseys, 30 points), or to Cows five years old and over failing to obtain 32 points (or in the case of Jerseys 35 points).

The cows were weighed and divided into the respective classes of over and under 900 lb. live weight on Tuesday, June 25. They were also stripped out that evening at 5 p.m., the milk of the next twenty-four hours being taken for the test.

The following table gives the full results of the tests:—

TABLE VI.—RESULTS OF BUTTER TESTS AT LINCOLN, JUNE 26, 1907.  
CLASS 185 A.—COWS OF ANY BREED OR CROSS, EXCEEDING 90 LB. LIVE WEIGHT. 26 ENTRIES.

No. in Class	Exhibitor	Name of cow	Breed	Live weight	Date of birth	Date of last call	No. of days in milk	Milk yield in 48 hours	Butter yield to the butter	Ratio of butter to the milk	Colour and quality of butter		No. of points for location	No. of points for butter	Total No. of points	Awards	CHURNING TABLE							
											Colour	Quality					Began	Finished	Duration (minutes)	Dairy	Cream churn	Turner		
831	T. Hunter	May Duchessa	Shorthorn	1316	May 2, '91	May 21	36	58	10	37	26	Very good	37.75	Nil	37.75	—	10	12	10	41	59	60	52	56
832	J. Evans	Burton Vic Ind	Linc'n Red	1327	Aug. 27, '96	March 21	37	63	2	3	26.75	Good	37.75	5.70	43.45	2nd prize, 10¢, & 2nd S.P., 10¢.	10	23	11	0	37	80	52	38
835	J. Evans	Burton Scarlett	Linc'n Red	1340	Nov. 18, '90	May 28	29	56	1	134	28.30	Fair	31.75	Nil	31.75	Withdrawn	10	18	11	0	43	60	52	57
846	J. Evans	Burton York 3rd	Linc'n Red	1295	Aug. 24, '90	April 8	79	47	0	104	28.37	Fair	36.50	3.90	30.40	—	10	29	10	56	37	60	52	58
847	J. Evans	Burton Ruddy 5th	Linc'n Red	1372	Oct. 3, '91	May 5	52	51	0	74	34.25	Poor	33.75	3.90	34.95	—	10	21	10	57	30	60	52	57
848	J. Evans	Burton Spot 5th	Linc'n Red	1328	Mar. 23, '03	April 20	61	40	12	7	28.31	Poor	33.90	2.70	25.70	H. C.	10	31	11	3	32	60	52	56
849	J. Evans	Burton Violet	Linc'n Red	1458	Feb. 1, '90	May 4	53	56	8	4	24.93	Fair	36.75	3.90	35.05	—	10	30	11	0	30	60	52	53
850	J. Sawyer	Bracebridge 11th	Linc'n Red	1288	Mar. 1, '90	May 10	40	59	1	54	35.10	Fair	34.50	3.90	30.10	—	10	40	11	4	36	60	52	57
851	W. P. Vesper	Homegr 3rd	S. Devon	1408	Nov. 7, '94	March 5	113	57	0	2	35.06	Excellent	32.50	7.30	26.00	H. C.	10	36	11	6	30	60	52	57
1073	J. S. Wroth	Nosegr 4th	S. Devon	1340	Jan. 4, '90	Feb. 4	142	36	1	94	27.90	Fair	35.30	10.30	35.70	H. C.	10	42	11	24	42	60	52	58
1145	Sir W. Garbett	Desiree of Johns	Red Poll	1323	Dec. 28, '90	April 23	84	44	14	134	24.34	Good	35.25	2.40	31.65	—	10	57	11	20	33	61	52	55
1314	Bart.	Phyllis	Jersey	981	Feb. 27, '96	Jan. 27	130	29	10	1	10.34	Excellent	34.50	11.00	35.50	Cert. of Merit	11	7	11	20	39	63	58	57
1310	T. Healy & D. Hoop	Phyllis	Jersey	928	May 21, '99	March 29	95	37	18	2	17.77	Excellent	33.75	5.20	30.35	Cert. of Merit	11	21	12	30	43	63	52	56
1309	Sir H. Pennard	Wickham Fancy	Guernsey	1134	July 1, '03	Jan. 13	164	37	12	1	21.00	Excellent	35.75	12.90	40.75	R. & H. C.	11	51	12	34	43	63	52	57
1403	H. F. Plumtre	Melanic of Good	Guernsey	1073	Sept. 27, '90	Jan. 16	161	36	0	144	19.77	Excellent	35.75	12.90	40.75	3rd prize, 5¢, & 3rd S.P., 5¢.	11	46	12	40	54	63	52	58
1405	J. J. Small	Cleopatra of Good	Guernsey	1099	Mar. 20, '02	May 6	51	54	12	11	27.95	Excellent	37.25	1.10	18.35	—	11	56	18	48	47	63	52	57
1437	W. H. Hale	Ladys Pine	Longhorn	1400	Sept. 8, '02	May 11	46	44	2	0	21.74	Fair	32.75	6.0	33.35	H. C.	11	57	1	0	63	63	53	59
1438	G. Berry	Tiny's Daisy	Crossbred	943	Jan 1, 1901	March 16	102	51	30	1	24.86	Very good	36.75	6.20	30.65	H. C.	12	51	12	50	59	64	53	56
1434	J. Evans	Burton Daisy	Shorthorn	1284	1899	June 25	32	57	8	1	33.15	Poor	37.75	Nil	37.75	—	2	10	2	30	20	60	52	54
1435	J. Evans	Iris	Shorthorn	1435	1899	June 2	34	55	4	2	28.02	Fair	37.25	Nil	37.25	H. C.	2	12	2	30	25	60	52	58
1436	H. Kelly	Foreman	Shorthorn	1352	Unknown	March 25	30	53	10	1	27.90	Poor	37.75	3.90	30.05	H. C.	2	12	2	30	20	60	52	58
1439	G. A. Williams	Barbary	Jersey	1032	Feb. 10, '90	March 10	39	52	10	1	27.90	Excellent	34.25	7.10	31.35	H. C.	7	21	2	30	20	60	52	57
1440	G. A. Williams	Barbary	Jersey	1071	1902	March 10	117	45	10	1	28.25	Good	34.25	7.10	31.35	H. C.	7	21	2	30	20	60	52	57
1489	The Marquis of Winchester	Wrench	Jersey	910	May 6, '99	March 2	116	41	2	7	16.87	Good	35.00	7.90	40.60	1st prize, 10¢, G.M., & 1st S.P., 20¢.	2	15	3	22	47	60	52	55

The "Butter Ratio" represents the number of lb. of milk required to make 1 lb. of butter. Ten lb. of milk are reckoned as equal to an imperial gallon. A Special Prize of the English Jersey Cattle Society.





TABLE VI.—RESULTS OF BUTTER TESTS AT LINCOLN, JUNE 26, 1907—*continued*.  
CLASS 185 B.—COWS OF ANY BREED OR CROSS NOT EXCEEDING 90 LB. LIVE WEIGHT. 11 ENTRIES.

No. in Catalogue	Exhibitor	Name of cow	Breed	Live weight	Date of birth	Date of last calf	No. of days in milk	Milk yield in 48 hours	Buttery field	Ratio of fat to lb. butter	Colour and quality of butter		No. of points for butter	No. of points for No. of points for	Total No. of points	Awards	CHURNING TABLE					
											Colour	Quality					Began	Finished	Duration (minutes)	Daily	Percentage fat, % F.	
1316	R. H. Cobb	Leonides Dainty	Jersey	872	Mar. 12, '99	Feb. 7	129	27 23 1 9	1776	1776	Fair	Very good	28300	990	3490	—	11 14	12 0	46	62	52	58
1325	A. Miller-Halbeth	Vanilla 2nd	Jersey	826	Apr. 15, '99	Mar. 20	88	48 8 1 6½	3943	3943	Good	Poor	23750	480	3930	—	11 29	12 5	35	62	62	56
1326	Mrs. Eyles Mon-sell	Peace	Jersey	872	Nov. 13, '92	April 8	79	46 6 2 3½	1896	1896	Poor	Fair	3375	390	3965	3rd prize	11 26	12 19	43	63	52	55
1330	Mrs. Maitland Spence	Portia	Jersey	798	Apr. 6, '92	Jan. 23	154	—	—	—	—	—	—	11 40	—	—	Withdrawn	—	—	—	—	—
1334	R. Bruce Ward	Lucy	Jersey	858	July 24, '00	Jan. 25	132	34 4 1 9½	2170	2170	Excellent	Fair	25225	1170	26345	Cert. of Merit	11 45	12 16	31	63	52	57
1322	G. Berry	Dewberry	Jersey	784	Feb. 13, '93	May 13	44	57 4 2 5½	2439	2439	Good	Very good	37225	46	3765	R.N. & Cert. of Merit	12 26	12 26	33	64	52	56
1327	C. and M. Palmer	May	Jersey	826	Mar. 29, '97	Feb. 6	140	34 14 1 4½	1965	1965	Excellent	Very good	30225	1906	39225	—	2 10	2 30	29	65	52	57
1331	J. Carson	Mary's Beauty	Jersey	854	Oct. 7, '90	Feb. 8	138	34 4 2 0½	1999	1999	Fair	Good	3225	980	42 05	1st prize, & S. M.S.	2 20	3 2	42	66	52	59
1332	J. Carson	Yvesan	Jersey	826	1888	Jan. 26	131	35 12 1 14	1996	1996	Excellent	Excellent	30700	1170	4110	2nd prize, & B. M.S.	2 18	2 56	38	66	52	57
1333	Mrs. Eyles Mon-sell	Heartsease	Jersey	872	Sept. 29, '90	April 1	86	33 12 1 12½	1878	1878	Very good	Good	2875	490	3335	—	2 24	3 0	26	65	52	57
1334	R. Bruce Ward	Silken Phyllis	Jersey	714	Mar. 23, '03	Mar. 13	103	36 2 1 5½	1921	1921	Fair	Fair	2175	620	2825	—	2 25	3 0	40	65	52	60

1. The "Butter Ratio" represents the number of lb. of milk required to make 1 lb. of butter. Ten lb. of milk are reckoned as equal to an imperial gallon.  
2. Silver Medal.  
3. Bronze Medal.



146 *Milk and Butter Tests at the Lincoln Show, 1907.*

The next table gives the number of cattle competing and the various breeds represented, and for the sake of comparison, the corresponding numbers at Park Royal in 1905 and Derby in 1906 are also given.

TABLE VII.—*Number of Cattle entered under their respective Breeds.*

Breed	Park Royal, 1905	Derby, 1906	Lincoln, 1907
Shorthorns	5	2	4
Lincolnshire Red Short-horns	1	2	8
South Devons	2	2	2
Red Polled	2	—	1
Jerseys	21	17	14
Guernseys	4	2	4
Longhorns	—	—	1
Crossbred	—	—	1
Total	35	25	35

Table VIII. gives the full particulars of the prize animals in the two classes, and also shows the winner of the special prizes and medals.

TABLE VIII.—*Prize Winners in Butter-test Competition.*

CLASS 185 A.—COWS EXCEEDING 900 LB. LIVE WEIGHT.

Name of exhibitor	Name of cow	Breed	Live weight	Days in milk		Butter	Ratio	Points	Result
				Milk	Butter				
			Lb.	Lb. oz.	Lb. oz.	Lb.			
The Marquis of Winchester	Wench	Jersey	910	116	41 2	2 7	1657	4680	1st Prize
J. Evens	Burton Victor 2nd	Lincoln. Red Sh'thorn	1302	97	63 2	2 5½	2675	4345	2nd Prize
H. F. Plumtree	Melanie of Goodstone 2nd	Guernsey	1078	161	38 0	1 14½	1977	4375	3rd Prize

CLASS 180 B.—COWS 900 LB. LIVE WEIGHT AND UNDER.

Name of exhibitor	Name of cow	Breed	Live weight	Days in milk		Butter	Ratio	Points	Result
				Milk	Butter				
			Lb.	Lb. oz.	Lb. oz.	Lb.			
J. Carson	Mary's Beauty	Jersey	854	138	24 4	2 0½	1499	4305	1st Prize
J. Carson	Yonan	Jersey	826	151	25 12	1 14	1906	4170	2nd Prize
Mrs Ryres Monsell	Peace	Jersey	872	79	40 6	2 2½	1806	3875	3rd Prize

The special prizes of 20*l.*, 10*l.*, and 5*l.*, and the Gold, Silver, and Bronze Medals (the latter limited to Jersey cows) given by the English Jersey Cattle Society, were awarded as follows:—

Special Prize 20l.	The Marquis of Winchester's	Jersey.
	Wench	
" " 10l.	Mr. J. Evens's Burton Vic	Lincolnshire Red
	2nd	Short-horn.
" " 5l.	Mr. H. F. Plumptre's Melanie	Guernsey.
	of Goodnestone 2nd	
Gold Medal	The Marquis of Winchester's Wench.	
Silver Medal	Mr. J. Carson's Mary's Beauty.	
Bronze Medal	Mr. J. Carson's Yosan.	

Out of the thirty-five animals tested, nineteen received prizes or cards of commendation, comparing, in this respect, unfavourably with the results last year at Derby.

The cold season and the wet weather during the first two days of the Show may perhaps account for this, as, with the exception of the Guernseys, the average number of points gained shows a falling off.

The next table gives the averages of all the cattle tested at Lincoln, while Table X. shows the average points gained by the various breeds at Park Royal, Derby, and Lincoln.

TABLE IX.—Averages of Cattle Tested.

No. of cows competing	Breed	Live weight	Days in milk	Milk		Butter		Ratio	Points
				Lb. oz.	Lb. oz.	Lb. oz.	Lb. oz.		
4	Shorthorns	1335	46	58 12	1 14 $\frac{3}{4}$	30.94	31.70		
8	Lincoln. Red do.	1436	69	51 1	1 11 $\frac{1}{4}$	29.24	31.06		
2	South Devons	1519	127	46 12	1 13	25.79	37.75		
1	Red Polled	1323	64	44 14	1 13 $\frac{1}{2}$	24.54	31.65		
1	Longhorns.	1400	46	44 8	2 0 $\frac{3}{4}$	21.74	33.35		
14	Jerseys	860	113	36 10 $\frac{5}{8}$	1 13 $\frac{1}{2}$	19.38	36.61		
4	Guernseys.	1095	123	35 4 $\frac{1}{2}$	1 9 $\frac{1}{2}$	22.35	33.45		
1	Crossbred	945	102	51 10	1 14 $\frac{3}{4}$	26.86	36.95		

TABLE X.—Average points won by Cattle at Park Royal, Derby, and Lincoln, with the numbers competing at the three Shows.

Breed	Park Royal, 1905		Derby, 1906		Lincoln, 1907	
	No. of Cows	Points	No. of Cows	Points	No. of Cows	Points
Shorthorns	5	27.71	2	37.77	4	31.70
Lincolnshire Red Short-horns	1	23.45	2	38.45	8	31.06
South Devons	2	24.57	2	41.40	2	37.75
Red Polled	2	20.07	—	—	1	31.65
Longhorns	—	—	—	—	1	33.35
Jerseys	21	40.63	17	37.95	14	36.61
Guernseys	4	26.37	2	29.25	4	33.45

### III.—EXPERIMENTS IN THE DAIRY.

The experiments carried out in the Dairy at Lincoln were undertaken with a view to ascertain—

1. The comparative weight and value of a given quantity of cream from the milk of the various breeds of dairy cattle present in the Show Ground.

2. The comparative weight of a given quantity of milk from the respective breeds of dairy cattle.

3. The effect that the artificial colouring of milk and butter may have on the mind of the purchaser, and so on the sale price of these articles of food.

With regard to experiments undertaken in a showyard dairy a word or two is necessary, since it must always be borne in mind that the ordinary work of those connected with that department of the Show is heavy, and that a dairy in a showyard cannot be equipped with all those appliances found in a laboratory, so that experiments must necessarily be of a rough and ready kind. On the other hand, in no place but at a Show of the same dimensions as that of the Royal Agricultural Society can milk from all the dairy breeds of cattle be obtained in its pure form—pure because it comes straight from the cow to the dairy, and also because all the cattle are pedigree, and therefore the milks genuinely represent the breed of cattle from which they are obtained.

As the cows were milked, both morning and evening, the milk was brought to the dairy by each herdsman, who received payment for the same, first giving the name of the owner and the breed of the cow. This is in accordance with Regulation 62 in the Prize Schedule.

The milk was next strained and poured into its particular receptacle, churns having been previously labelled with the names of the various breeds of cattle in the yard. In this way good quantities of the milk of each breed were collected from which a fair average sample of milk was obtained.

So much by way of preface. The first experiment undertaken was one with cream, viz., to arrive, if possible, at the weight and value of a given quantity of cream.

#### EXPERIMENT NO. 1.

##### *Weight and value of Creams.*

Several gallons of the particular milk to be experimented with were heated up to 100° F. and run through a steam turbine separator. After the cream had been running some time a quart measure was held under the cream spout until it was nearly full. A smaller measure was at once similarly filled, and the original quart measure was then weighed on scales, being filled while on the scales up to the brim with the

cream from the smaller measure. The weight of the cream was then noted, the tare of the quart measure being deducted.

The separator was washed out between each lot of milk, the milks all being heated to the same temperature, while the separator was run at the same speed throughout.

The creams having been weighed were put aside for twenty-four hours to ripen, after which they were churned, the weights of the various lots of butter being carefully taken.

All the creams were churned at the same temperature. The butters were run through a centrifugal drying machine and were made up by the same assistant, so as to be as dry and as much alike as possible, the buttermilks in every case being retained to see whether any butter fat was left in them, which fortunately did not occur.

The following table (XI.) gives the names of the different breeds of cattle whose milks were experimented with, the quantities and weights of cream of each, and the butter obtained therefrom.

The butters are all worked out at an uniform rate of 1s. 4d. per lb. which may appear too high a figure for all of them, but I have used this price because, in the first place, it is easy to calculate the value when the price is 1d. per ounce, and fractions other than farthings are avoided, and secondly because cream commands a relatively higher price than butter, so that although the butter price may be thought high, the value of the cream worked out from the butter figures is not at all excessive.

In a second column the butter has been priced out at its market value, taking 1s. 4d. per lb. as the top price of the butter, and from these figures the creams will be assessed more nearly to their proper value per quart.

TABLE XI.

Breed	Cream			Butter				Cream	
	Qt.	Lb. oz.	Lb. oz.	Estd. rate	Cost	Market rate	Cost	Estimated	Market
	1	2 5	1 4	s. d.	s. d.	s. d.	s. d.	s. d.	s. d.
Shorthorns				1 4	1 8	1 2	1 5 $\frac{1}{2}$	1 8	1 5 $\frac{1}{2}$
Lincolnshire	Red								
Short-horns		2 4	1 6 $\frac{1}{2}$	1 4	1 10 $\frac{1}{2}$	1 2	1 7 $\frac{1}{2}$	1 10 $\frac{1}{2}$	1 7 $\frac{1}{2}$
South Devons		1 7 $\frac{1}{2}$	1 7 $\frac{1}{2}$	1 4	1 11 $\frac{1}{2}$	1 4	1 11 $\frac{1}{2}$	1 11 $\frac{1}{2}$	1 11 $\frac{1}{2}$
Red Polled		1 5 $\frac{1}{2}$	1 5 $\frac{1}{2}$	1 4	1 9 $\frac{1}{2}$	1 2	1 6 $\frac{1}{2}$	1 9 $\frac{1}{2}$	1 6 $\frac{1}{2}$
Ayrshires		1 5 $\frac{1}{2}$	1 5 $\frac{1}{2}$	1 4	1 9 $\frac{1}{2}$	1 2	1 6 $\frac{1}{2}$	1 9 $\frac{1}{2}$	1 6 $\frac{1}{2}$
Jerseys		1 7 $\frac{1}{2}$	1 7 $\frac{1}{2}$	1 4	1 11 $\frac{1}{2}$	1 4	1 11 $\frac{1}{2}$	1 11 $\frac{1}{2}$	1 11 $\frac{1}{2}$
Guernseys		1 8 $\frac{1}{2}$	1 8 $\frac{1}{2}$	1 4	2 0 $\frac{1}{2}$	1 4	2 0 $\frac{1}{2}$	2 0 $\frac{1}{2}$	2 0 $\frac{1}{2}$
Longhorns		1 5	1 5	1 4	1 9	1 3	1 6 $\frac{1}{2}$	1 9	1 6 $\frac{1}{2}$
Kerries		1 4 $\frac{1}{2}$	1 4 $\frac{1}{2}$	1 4	1 8 $\frac{1}{2}$	1 3	1 6 $\frac{1}{2}$	1 8 $\frac{1}{2}$	1 6 $\frac{1}{2}$
Dexters		1 4 $\frac{1}{2}$	1 4 $\frac{1}{2}$	1 4	1 8 $\frac{1}{2}$	1 2	1 6	1 8 $\frac{1}{2}$	1 6

From this it will be seen that the milks of the South Devon and the Channel Island breeds of cattle produce the best and most valuable cream.

## EXPERIMENT NO. 2.

*Weights of various Milks.*

Having been asked in the Showyard "which weighed the heavier—a gallon of Shorthorn or a gallon of Jersey milk?" I carried out the following experiment:—

From the bulk of each lot of milk, which as already described, was collected in separate churns, I took about  $1\frac{1}{4}$  gallons by measure, the milk having in each case been thoroughly well mixed in order to obtain as accurate a sample as possible.

I then filled a gallon measure to the brim and poured the milk into a pail, the tare of which had been previously ascertained. The pail and its contents were then weighed on scales, and the net weight of the milk noted. This experiment was carried out with both morning and evening milks.

The following table gives the weights of morning and evening milks, and the average weights of the two.

TABLE XII.

Breed	Morning milk		Evening milk		Average Weight of 1 Gallon	
	Measure	Weight	Measure	Weight		
	Gallon	Lb. oz.	Gallon	Lb. oz.	Lb. oz.	
Shorthorns	1	10 5 $\frac{1}{2}$	1	10 4 $\frac{1}{2}$	10 4 $\frac{1}{2}$	
Lincolnshire Red Short-horns.	1	10 5 $\frac{3}{4}$	1	10 4	10 4 $\frac{7}{8}$	
South Devons.	1	10 4 $\frac{1}{2}$	1	10 4	10 4 $\frac{1}{2}$	
Red Polled	1	10 5	1	10 4 $\frac{1}{2}$	10 4 $\frac{7}{8}$	
Ayrshires	1	10 4 $\frac{3}{4}$	1	10 5 $\frac{1}{2}$	10 5	
Jerseys	1	10 2 $\frac{3}{4}$	1	10 3	10 2 $\frac{3}{4}$	
Guernseys	1	10 4	1	10 4	10 4	
Longhorns	1	10 4 $\frac{1}{2}$	1	10 3 $\frac{3}{4}$	10 4 $\frac{1}{4}$	
Kerries	1	10 4	1	10 5 $\frac{1}{2}$	10 4 $\frac{7}{8}$	
Dexters	1	10 4 $\frac{3}{4}$	1	10 3 $\frac{1}{2}$	10 4	

It will be seen that a gallon of Shorthorn milk is heavier than a gallon of Jersey, and generally that the richer the milk the lighter it is in weight, the weights of the evening's milk, with three exceptions, being lighter than the morning's.

This experiment would bear repetition, when gauged glasses or a hydrometer might be used to ensure more accuracy, for no matter what care is taken, with ordinary gallon measures it is impossible to guarantee absolute accuracy.

## EXPERIMENT NO. 3.

*The Colouring of Milk and Butter.*

The following simple experiment in colouring milk was carried out during three days of the Show with the object of demonstrating that the public are taken in by the colouring

of milk, a practice allowed by the Legislature so long as the colouring matter is not injurious to health.

Two samples of milk were taken, the one from the milk of the Jersey cows, the other from the palest milk I could obtain from another breed of cattle.

The values of the two milks, if bought for a factory, on the fat present in the milk, would be respectively about 1s. and 9d. per gallon, the butter ratio working out in the one case under 2 gallons and in the other nearly 3 gallons.

Eight small 4-ounce bottles were filled with the milk as below.

- 2 with the Jersey milk, labelled No. 1.
- 2 with the white milk, labelled No. 4.
- 2 with the white milk coloured to represent the Jersey, labelled No. 2.
- 2 with the white milk coloured deeper than the Jersey, labelled No. 3.

Four of these bottles (*i.e.*, one set of each of the different samples) were put on ice to allow the cream to rise, and these were covered over with muslin in the Dairy to prevent them being seen by any one. The other four samples were kept warm and shaken occasionally, so as to prevent the cream rising.

On several occasions during the three days that this experiment was carried out I handed round the four bottles containing the warm milk amongst the public, who were watching the proceedings in the Dairy, with a request that they would give their opinion on the different samples by holding up their hands as I called out the numbers on the bottles, and keeping them up while I counted them. I explained that all the samples were pure, but that, as a matter of curiosity, I was anxious to find out whether they (the audience) knew the value of milks from the purchasing point of view.

On every occasion No. 3 sample secured the most votes, while No. 4 received none at all. A very few voted for Nos. 1 and 2, opinions between them being pretty equally divided.

After the bottles were returned to me I told the audience what each bottle contained, and how it had been treated, and then handed round the four bottles in which the cream had risen.

I took pains to explain that the colouring of milk was allowed so long as the colouring-matter was not injurious to health, but I also recommended that in purchasing milk a guarantee should always be obtained from the vendor that the milk sold was not coloured.

The experiment apparently demonstrated what it was intended to do, viz., that the general public judge milk by its colour, and that to colour the paler milks so as to pass them off for the milks richer in fat is a practice that cannot be commended.

Experiments of a similar nature with butter were also carried out. In every case the pale butters were voted as the worst, the deepest in colour always obtaining the highest number of adherents, while the best butter was passed by. In this experiment the samples were three in number. No. 1, Best Jersey butter of a good natural colour; No. 2, white butter coloured to be darker than the Jersey; No. 3, white butter uncoloured.

In carrying out these experiments, and generally in the work of the Dairy, I was greatly assisted by Mr. T. W. Ashton, my Assistant Steward, Mr. Gilbert, and the Staff of the Dairy, all of whom worked hard and well.

ERNEST MATHEWS.

Little Shardeloes,  
Amersham.

---

## AGRICULTURAL EDUCATION EXHIBITION.

AS on recent occasions, an exhibition was organised by the Education Committee of this Society, in co-operation with the County Councils Association, the Royal Meteorological Society, and various Agricultural Colleges. To this was allotted a prominent building to the right of the main avenue, in the centre of the Showyard at Lincoln. Much attention was directed to the exhibits here brought together, and designed to show what was being done by various institutions as well as by the Society itself for the promotion and development of agricultural education. A considerable distribution was made of various forms of literature from some of the stands occupied in this section, and much direct information was afforded to visitors by verbal explanation of the exhibits and the scientific work they represented by the gentlemen in charge of each stand.

Mr. J. Bowen-Jones again acted as Steward of this very interesting section of the year's Show.

### METEOROLOGY.

Royal Meteorological Society, 70 Victoria Street, Westminster.—On the left of the entrance a department was organised under the supervision of Mr. W. Marriott, Assistant Secretary of the Royal Meteorological Society, to illustrate the



work of that Society in diffusing a knowledge of the science of Meteorology. A grass plot, 20 feet square, adjoining the exhibition building, was also arranged as a typical Climatological Station ; and in this the following instruments were exhibited in position :—(1) Stevenson thermometer screen, fitted with dry-bulb, wet-bulb, maximum and minimum thermometers ; (2) Snowdon rain-gauge and measuring-glass ; (3) Black-bulb and bright-bulb solar radiation thermometers *in vacuo* ; (4) Grass minimum thermometer ; (5) Campbell-Stokes sunshine recorder ; and (6) Earth thermometers at depths of one and four feet. The daily observations taken at this station were posted in the Exhibition and were much consulted by visitors.

Inside the building, in two bays thrown into one, an interesting collection of instruments, diagrams, photographs, models, &c., was shown. Among the most important of these were the following :—

#### RAINFALL.

1. Dr. H. R. Mill's maps of the British Islands, showing (1) the distribution of mean annual rainfall, 1870-99 ; (2) the rainfall of the wettest year, 1872 ; and (3) the rainfall of the driest year, 1887.

2. Dr. Mill's specially prepared map of the average annual rainfall for the county of Lincolnshire, based on observations for the years 1868-1902.

3. Statement of annual rainfall at Nottingham, 1867-1906.

4. Statement of yearly rainfall at Boston, 1826-1906. This diagram showed the dryness of the last 20 years in a very striking manner.

5. Diagram showing the monthly distribution of rainfall according to altitude up to 1,000 ft. above sea level in the west and east of England. This diagram brought out prominently the fact that the higher the altitude the greater is the rainfall, and also that the western districts have a heavier rainfall than those in the east.

In connection with these statements it should be noted that the fallacy of taking too short a period in which to base a true local average of rainfall was well illustrated by the figures shown for the annual rainfall at Nottingham, which were as under :—

Year	Rain	Year	Rain	Year	Rain	Year	Rain
	Ina.		Ina.		Ina.		Ina.
1867 ...	29-90	1877 ...	23-77	1887 ...	15-64	1897 ...	23-73
1868 ...	25-53	1878 ...	23-84	1888 ...	19-99	1898 ...	19-75
1869 ...	27-75	1879 ...	27-31	1889 ...	25-61	1899 ...	22-64
1870 ...	17-93	1880 ...	35-45	1890 ...	17-70	1900 ...	28-53
1871 ...	26-83	1881 ...	27-49	1891 ...	25-89	1901 ...	20-44
1872 ...	35-90	1882 ...	34-48	1892 ...	21-58	1902 ...	21-52
1873 ...	20-51	1883 ...	30-05	1893 ...	20-17	1903 ...	32-37
1874 ...	18-14	1884 ...	20-10	1894 ...	20-25	1904 ...	19-73
1875 ...	31-71	1885 ...	26-66	1895 ...	20-75	1905 ...	20-01
1876 ...	29-31	1886 ...	31-76	1896 ...	22-99	1906 ...	23-94

Average 20 years ... 27-69.

Average 20 years ... 22-16.

The average for the whole period of forty years above shown is 24-93 ins. The values above this average are printed

in thick type, and those below in ordinary type. It will be noticed that during the first twenty years there were only four occasions on which the rainfall was *below* the average, and that during the second twenty years there were only four occasions on which the rainfall was *above* the average, the annual average for the first twenty years being as high as 27·69 in., while for the second twenty years it was only 22·16 in., thus showing a difference in the average of the two periods of 5·53 inches.

These Nottingham figures help to explain very largely how it has been that Leicester and other Midland districts have during recent years suffered from "water famines," for the rainfall during the last twenty years has been almost continuously below the average, and as more water is used than formerly there has also been a lowering of the underground water level.

The influence of weather upon agricultural crops was shown by the following further diagrams :—

1. Temperature, rainfall and wheat-crop at Rothamsted ; (1) good crops ; and (2) bad crops.

2. Temperature, rainfall and hay crop at Rothamsted ; (1) good crops ; and (2) bad crops.

3. Autumn rainfall and yield of wheat, 1884-1907. This diagram showed the relationship between the rainfall of the autumn and the subsequent yield of wheat as worked out by Dr. W. N. Shaw, on the basis of a formula by which he suggested that it was possible to forecast the wheat crop from the previous autumn rainfall.<sup>1</sup>

4. Diagrams were also shown illustrating the distribution of mean temperature over the British Isles ; (1) January ; and (2) July.

5. The annual average hours of bright sunshine recorded in the British Isles.

6. Mean direction of the wind for England and Wales, 1881-1905.

7. The relative forwardness of vegetation in various districts of the British Isles.

A large collection of photographs illustrating meteorological phenomena, such as clouds, lightning, damage by lightning, hail, damage by hail, snow, frost, floods, damage by gales, tornadoes, and whirlwinds was shown, and attracted a great amount of attention.

In addition to the above, among other interesting objects shown, were a collection of lightning conductors, showing marks of fusion at highest point—the only effect visible when conductors in good order are struck by lightning. A collection of defective lightning conductors was also shown.

A model of a chimney shaft showing method of protection from lightning, elevation rods and points for lightning

<sup>1</sup> It may, however, be noted in this connection that such an estimate may be found in practice defective unless account be taken of other factors influencing this result. Thus the forecast for 1907 on Dr. Shaw's formula, 27·5 inches per acre, has fallen much short of the result.

conductors ; and a case of points, copper tapes, and necessaries for lightning conductors, by Messrs. J. W. Gray & Son, were also exhibited.

Various patterns of meteorological instruments by Messrs. Negretti & Zambra and by Mr. J. J. Hicks, were also shown.

Weather Charts for 8 a.m. and 6 p.m., specially prepared by the Meteorological Office, and also a telegram giving the forecast for the weather, were posted up each day and lectures were given by Mr. W. Marriott on "Meteorology in Relation to Agriculture."

#### COLLEGIATE EXHIBITS.

**Cambridge University (Agricultural Department).**—The Department of Agriculture of this University again sent an exhibit consisting chiefly of specimens to show the work which is being done at Cambridge in the direction of breeding improved varieties of farm crops. Two large sized diagrams, composed of specimens showing the progeny of crosses between a small bearded club wheat and a lax eared beardless wheat, and between a black two-rowed barley and a white six-rowed barley, formed a conspicuous feature ; and these showed clearly the application of Mendelian ideas to the fixing of new types.

Loaves baked in the University Laboratories were shown to illustrate the difference in baking properties between ordinary English wheat and the best Canadian wheat ; and side by side with this were experiments to show the methods of chemically testing flour in order to ascertain its baking value, which have been worked out in the University Laboratory.

Specimens of new varieties of wheat combining English vigour and cropping power, with Canadian baking qualities, were also shown.

Another important exhibit was that showing the method of raising rust-proof varieties of wheat by hybridization and fixation on Mendelian lines. Attention may be called to this as supplying the first really definite contribution to the study of the inheritance of disease. Results of the greatest economic importance may be expected when these experiments have been further applied to other crops.

A number of photographs were also shown illustrating the first attempt to apply Mendelian Laws to the cross-breeding of sheep. This experiment is only in its preliminary stages, but the results already obtained show that by crossing Suffolks and Dorsets and mating first cross rams with first cross ewes, a second generation is obtained, in which re-combination of the characters takes place exactly as in the case of barleys and wheats.

A number of photographs of hybrids between various crucifers were also shown, and other photographs illustrating

the pathology of a common disease of Turkeys, known as "swollen head."

A number of diagrams to illustrate the results obtained in potato cultivation, in such directions as change of seed, cutting sets, sowing large and small sets.

Among the miscellaneous exhibits at this stand were shown specimens of barley damaged by "Helminthosporium," the disease which is commonly known as "blindness," and which can be most readily prevented by steeping the seed in Formalin solution, one part in about 200 of water.

**South Eastern Agricultural College, Wye, Kent.**—At the stand at the disposal of this College were shown collections of injurious insects, mammals, &c.; fungi, especially those destructive to fruit; various washes used as insecticides and fungicides; a collection of different types of horse shoes, dissections of horses' feet in various stages of disease, and bones of the horse's foot showing disease.

Photographs of various cross-breeds of sheep experimented with at the College Farms, and models showing systems of hop training, and various manures, cakes, &c., showing impurities were also exhibited.

The collection of insect pests (exhibited by Mr. F. V. Theobald) was in two parts, one of cases showing the insects in various stages and the damage done by them, the other living examples of some of the most harmful insects feeding on their natural food-plant under large bell jars. Amongst these were the very harmful apple sucker (*Psylla mali*), which is such a pest in the Worcestershire orchards. The adults only were present. In connection with this exhibit was a series of branches showing the different substances used to hold lime and salt wash on the trees, and photographs showing the treated trees. This wash has been shown in the recent Report on "Spraying for Psylla," issued by the Worcestershire County Council, to be the only successful way of fighting this enemy.

The other living insects included lackey moths, the caterpillars in their tents, the brown tail moth, once so abundant in Britain and which occurred again this season; caterpillars of the gold tail moth, and others that had been harmful during the season.

Amongst crop pests one bell jar contained living click-beetles, the parent of the wire-worm, and another the celery fly.

Amongst animal pests exhibited were the two warble flies (*Hypoderma lineata* & *H. boris*), with enlarged coloured drawings of each, and the life-history pointed out on labels. The exhibition of British mammals of economic importance included all those likely to be seen on the farm, such as the English and Irish stoats, the weasel, voles, mice and rats, the

hedgehog and squirrel, and the beneficial mole, also shrew mice. There were also a series of photographs showing various insects at work and the damage done by them, the most important being a new form of attack of the big bud mite on red currants.

Amongst the most important of the fungi exhibited by Mr. Salmon were the black scab or spot of apples, the cherry leaf scorch, the brown rot, and the American gooseberry mildew. Fresh specimens of the latter fungus on the berries were to be seen, showing how serious the attack of this fungus is, and what loss this recently introduced enemy would occasion if allowed to spread over the country.

The various stages of the scab on apples were shown, and the remedy pointed out, namely, spraying with Bordeaux mixture. The presence of scab on the wood in winter in certain places and on certain varieties was drawn attention to, and winter treatment for it advised. The best formulæ of fungicides were given over the jars of the washes exhibited. Amongst other exhibits may be pointed out the apparatus used for "Smudges" in fruit plantations, and the means of connecting a thermometer with an electric bell, so that the temperature can be recorded to anyone sleeping at a distance from the plantation.

The College also showed an almost complete collection of forest tree insect pests, formed by Mr. Theobald. Many large specimens were shown of insect damage, notably of the goat moth and living examples of forest insects at work, while a series of birds, useful in the forest as a means of checking insect damage was exhibited. This exhibit gained the Silver Medal.

**The Midland Agricultural and Dairy College, Kingston, Derby.**—Besides photographs and other illustrations descriptive of this College, the following notes may be given of the more important exhibits made on this occasion:—*Inoculation experiments.* These were illustrated by Pots of Oats growing in a black peaty soil (car soil), and inoculated respectively with nitrous, nitric, ammonia producing, putrefactive, and with mixtures of these organisms, the pots being compared with one which was uninoculated. The beneficial results of these inoculations could be clearly seen, more especially in the case of the nitrous organisms. The experiments were quite new, and it is to be noted that at present the results obtained in the field have not confirmed those of the pot experiments. An analysis of the soil showed it to be very rich in combined nitrogen (over 2 per cent.). The soil nevertheless produces very poor crops, nearly all the nitrogen existing in a form which is not available for plants.

In another exhibit *the availability of the Phosphates in Basic Slag* was demonstrated by a series of pots of sand in which mustard was growing, manured with equal quantities of

phosphate derived respectively from a good sample of Basic Slag, the portion of the same slag insoluble in 2 per cent. citric acid, and the coarse material which would not pass a sieve with 100 meshes to the linear inch. The conclusions to be drawn, when the pots were compared with a pot to which no phosphate was added, were that only that part of the basic which is soluble in 2 per cent. citric acid, and is included in the fineness, is immediately available for the mustard plant under the conditions of the experiment.

*The immediate effect of manures on pastures* was shown by the differences in growth between five boxes of turf which had been removed from a poor pasture on May 6th, and variously manured with soluble plant foods. The box which was manured with a complete manure showed a great increase on the control, and though the clovers had not grown to the same extent as in the box from which nitrogen was omitted, the growth was a little greater in quantity. The box receiving complete manure, without potash, came next, while that without phosphates was little better than the "no manure." All the boxes received lime, and it was noticeable that this indirect manure did not produce the immediate results which were obtained with the soluble direct manures.

*The results obtained with the growth of Sugar-Beet* in the Midlands during 1906 were shown by means of diagrams, and it was seen that for that year the yield and composition of the beets compared favourably with beets grown in any other part of the world. Full details of these experiments are published in Bulletin 7, 1906-7, issued by the Midland Agricultural and Dairy College.

*Cultures of Bacteria* were exhibited in cases, one of the most instructive of which showed the number of colonies formed by bacteria falling on a plate of gelatine in one minute. A plate exposed in a clean cow-byre grew thirty-six colonies, but after re-whitewashing only five colonies grew on another plate exposed for the same time. The number had only risen to twenty-two after eight days. It is highly significant that by whitewashing the cow-byre the number of organisms in the air could be reduced almost as low as the number occurring in the open field. A plate exposed in the open field grew four colonies.

*Micro-photographs* of Bacteria and also of seed impurities in cakes were shown.

#### EXHIBITS BY SOCIETIES.

**Royal Agricultural Society of England.**—The several scientific departments of the Society contributed largely to this section of the Show. The books, pamphlets, leaflets and diagrams published at different times by the Society were arranged in

such a manner that visitors could freely inspect them and purchase such as they wished to have.

The Zoological Department sent several cases of specimens illustrating insects generally considered to be injurious to plant life; while the Botanical section included a diagram in continuation of that exhibited in 1906, and illustrative of the "Germination of different farm seeds." This diagram contained the latest results obtained in observations on this interesting question.

There was also exhibited a fine collection of Weed Seeds of the farm.

**The Woburn Experimental Station.**—The exhibit from this experimental centre brought to the notice of visitors the most recent research work which the Society is conducting at its farm. To judge from the number of visitors which this exhibit attracted on each day the Show was open, the farming community is evidently beginning to display an intelligent appreciation of and interest in this class of work.

The principal exhibit showed in very marked manner the influence which magnesia exercises on the wheat plant according to the varying proportions in which it occurs in the soil, and chiefly in relation to the lime similarly contained. Pots with growing barley plants in them, and treated with lime and magnesia in varying proportions, were shown, and also specimens of the grain and roots of the wheat crop of the previous year. The modifications produced alike in the grain and in the manner and extent of root growth by magnesia in increasing amount relatively to lime were very remarkable. As the relative proportion of magnesia was increased, so the grain became more glutinous and the root more developed and of a fine feathery nature.

The influence of lime in different forms, such as caustic lime, ground lime, ground limestone, &c., was shown on a soil poor in lime, and "sour" in character. The effect on the growth of the weed spurry (*Spergula arvensis*) was very striking.

There were also exhibits illustrating differences of "physical condition" in soils. Different soils were resolved into their various constituent particles, these varying greatly in size and number, while their relative behaviour to water was illustrated in a further series. There was also a collection of photographs and diagrams showing the yields of corn and straw from the different plots of stackyard field, Woburn, over a long series of years.

Other exhibits on this stand were:—

- (a) Good and bad quality soot (with analyses).
- (b) Red rangoon beans, a kind which have been proved to do much injury when given to stock.

(c) Micro-photographs of some of the common weed seeds found in feeding cakes, &c.

Mr. H. M. Freear, from the Woburn Experimental Station, attended throughout the whole time the exhibition was open, and was assiduous in describing the work to the many who interested themselves in it.

**County Councils Association.**—The experiment tried by the County Councils Association at Derby in 1906, of holding an exhibition of Rural School Work, was repeated on a larger scale at Lincoln in 1907. Of the counties invited by the Education Committee of the County Councils Association to exhibit, seven, viz., East Suffolk, Herts, Kesteven, Lindsey, Leicestershire, Northants and Notts, accepted the invitation, which was also extended to and accepted by three Reformatory and Industrial Schools.

The four bays provided for this exhibit proving inadequate, an annex was erected, and the display attracted a constant stream of visitors. The local Committee have estimated that from thirty to forty thousand persons, including a large number of those connected with educational administration, visited the educational section during the week.

The arrangements made enabling teachers and scholars in contributing counties to enter the Show ground at half-price on either of the two final days permitted some 2,500 teachers and children to avail themselves of this opportunity.

Members of the Sub-Committee or experts representing the education authorities concerned with the exhibits were present during the whole of the week, and explained the salient features to parties or individuals desiring information.

Pamphlets explaining the scope of the exhibition and the system of education in the above counties, and leaflets, setting out what nature study is, and the educational value of school gardening were distributed.

On Friday in the Show week, the public school managers and teachers were invited to a conference, at which over 300 were present. Mr. Christopher Turnor presided, and four subjects were discussed. Mr. T. S. Dymond, His Majesty's Chief Inspector of Rural Education, opened the subject of the "True Aim of Nature Study." The Rev. A. Thornley, Superintendent of Nature Study for Notts and Leicestershire, dealt with the allegation that Nature Study encourages the destruction of rare plants and insects. Mr. Turnor introduced the subject of School Gardens, and a paper on Elementary Meteorology, by Mr. Marriott, was read.

The exhibits included maps indicating the position and number of the educational institutions of all grades in the different counties, schemes and plans of school gardens and



illustrations of school garden work, drawings of natural objects, essays and original note books by children, mounted collections of natural objects, weather charts, and nature calendars, and specimens of handicraft of a rural nature.

The local committee expressed themselves convinced that these exhibitions of rural school work do great good ; enabling the public, especially those connected with the land, to realise that an effort is now being made to teach rural children something bearing upon rural pursuits, and to interest them in the life of their countryside. In this connection it is interesting to find it quoted from the returns of the Board of Education, that whereas only one school department was teaching gardening in 1894-5, with an average attendance of nine scholars, in 1903-4 there were 394 departments with 5,615 scholars.

**Agricultural Education Association.**—This body, of which Mr. J. F. Blackshaw, F.C.S., the Principal of the Midland Agricultural and Dairy College, is honorary secretary, had allotted to them a stand for agricultural literature. On this the prospectuses and reports of the various centres of agricultural instruction were provided, with numerous published statements of experimental work. The Society is much indebted to the Colleges and other institutions for liberality in supplying literature of this nature for distribution, and Mr. Blackshaw reports that the appreciation of this feature of the Show, by the many visitors attracted to the educational exhibits, was illustrated by the continuous demand experienced for these publications, the stock of which was exhausted by the end of the week.

---

## REPORT ON THE FORESTRY EXHIBITION AT LINCOLN.

By H. J. ELWES, F.R.S., President of the Royal English  
Arboricultural Society.

THOUGH I confess that I had some doubt as to whether the attempt to get up a general exhibition in all branches of forestry at the same time would be successful, yet my doubts were entirely dissipated when I saw it. And when the time, trouble, and expense in making and arranging such exhibits, as were sent by several noblemen and gentlemen, among whom the President of the Royal Agricultural Society is pre-eminent, is considered, we must acknowledge that the interest in this branch of rural economy is rapidly growing, and congratulate the Society most heartily on the very instructive and admirable show which was made.

I have some doubt as to whether the conditions laid down for the preparation of the boards of hardwood timber in Class 1 are the most suitable, as I think that oak sawn on the quarter would show quality better, and two or three inch boards would probably be a less wasteful thickness for freshly cut timber, as most of this was, than one inch. I would therefore suggest that more latitude be allowed to exhibitors in future with regard to the length and thickness.

In Class 1, the Marquis of Exeter had three fine boards, his ash being, I thought, of better quality than that shown by the Duke of Wellington. The Earl of Yarborough was placed third, and a fine board of brown oak was shown by Earl Fitzwilliam, whose land is renowned for producing this beautiful timber.

In Class 2, the Earl of Carnarvon showed one of the finest samples of larch that could be imagined, which probably secured him the first place. None of the samples of spruce or Scots pine, however, were equal in quality to what can be grown farther north, and they had been grown too fast to compare with Baltic or White Sea timber.

In Class 3, the Earl of Yarborough was easily first, his specimens of chestnut, sycamore, lime, acacia, and red oak being especially good. The walnut, however, was too young to show the quality that this valuable timber attains on suitable soil.

In Class 4, the Earl of Carnarvon had the best samples of Corsican and Weymouth pine that I have seen in England, but the silver fir seemed comparatively poor in quality, and like all the pines, spruces, or silver firs, must be grown more densely and slowly if it is to compete with foreign timber of the same species. In this class, the Earl of Yarborough showed a good clean-grown sample of Lebanon cedar and very fair boards of silver fir, but the Wellingtonia, Cryptomeria, and Douglas fir were all too young to show good quality, and there was not a single really fine board of Douglas fir in the whole exhibition. After studying in America the conditions under which the imported timber of this fine tree is produced, I have no hesitation in saying that I believe it will be much more profitable if cut young as pit timber, or when larger for estate purposes, than if we attempt to grow it to maturity, as very few places in England will carry this tree thick enough on the ground for a long enough time to compete with Oregon timber.

In Class 5, Specimens of Damage done by Insects to Forest Trees, Mr. Gillanders, Forester to the Duke of Northumberland, would have been, as might be expected, easily first, for I hardly think it fair to put an individual in competition with an institution like the Wye Agricultural College, where an able Professor like Mr. Theobald has a number of students to help

him. No practical forester in Great Britain is such a high authority on Forest Entomology as Mr. Gillanders, and the work he is just publishing on this subject should be of great value to all foresters in this country. In this section, but not for competition, Lord Moreton showed specimens of a moth attacking the larch (*Tinea lævigatella*) that has recently been attracting attention.

In Class 6 Mr. Reid, Forester to Lord Burton, showed fair but not fine samples of larch, to show the effect of different soils and situations, that grown on a north aspect being the best.

In Class 8, showing the effects of good and bad pruning, the Duke of Northumberland was first with some very instructive specimens, though such are easier to show on the growing tree than when taken off. Sir Montagu Cholmeley was second in this class.

In Class 9, Mr. Havelock showed specimen stems from the Earl of Yarborough's extensive plantations, showing the effects of dense and thin cropping on the quality of timber, but they were hardly large enough to do full justice to this very important and, for English foresters, difficult subject. The Marquis of Exeter showed specimen stems of ash and larch in the same class, but I thought that neither the ash or the larch from open situations were fair samples of what might be found on any estate where the land is suitable for either of these trees.

In Class 10, Lord Yarborough sent one of the most extensive and meritorious exhibits in the whole series, showing the damage done to various trees by squirrels and mice, whose ravages are in some places as extensive, and much more difficult to prevent, than those caused by rabbits. In this class he also showed a remarkable collection of the abnormal tufted growths known as witches brooms, from no less than fifteen kinds of trees, and an interesting collection of burrs, from thirteen species, most of them, however, too small or not sound enough to have any commercial value.

In Classes 11 and 12, a number of oak and other gates were shown from the estates of the noblemen already named. Excellent gates most of them were, but the cost prices given seemed to me higher than ordinary proprietors would be justified in paying, unless the superior durability of these costly gates could be proved by experience. My own experience is that in a hunting country a lighter and cheaper gate is better, because if made to open and shut itself as easily as a horseman requires, a heavy gate gets shaken to pieces before it is decayed. I have excellent farm gates made at half the cost of some of these, with split ash poles for the bars, and oak heads and tails, and I have also had light durable gates made from tough, slowly grown wych elm poles. Allowing 12s., or even 15s., for

a pair of oak posts, though I would prefer acacia where this wood is procurable, and 6s. to 10s. for the gate itself, it seems to me that 20s. to 25s. ought to be the outside price for ordinary farm gates, complete, but I should not like to have awarded the prizes in these classes without the assistance of an experienced estate carpenter.

Class 14, and also Section 4, produced an excellent exhibit of creosoted home-grown timber from the Lords Yarborough and Fitzwilliam, the particulars given with the former, of the amount of creosote absorbed by different sorts of timber, being very full and instructive. Whether the expensive plant necessary to inject creosote under pressure is economical on estates of moderate size, seems to me somewhat doubtful; but I have found that a simple covered tank with a furnace below it, in which hurdles, gates, and fencing timber can be steeped for twenty-four hours in heated creosote, is sufficient for such small timber, and there are various other wood preservatives which are preferred by some as cheaper than, or more easily applied than creosote. Here, again, a good deal of technical knowledge would be required in order to award prizes justly.

Among the articles for exhibition only, for which no prizes were offered, Section 1 contained a small collection of seeds and cones of trees shown by the University College of North Wales. In Section 2, five collections of living trees and shrubs were shown by nurserymen, of which that from Messrs. Fisher, Son & Sibray, of Handsworth Nurseries, seemed to me distinctly the best, and included several rare ornamental trees, such as *Quercus Mirbecki*, and *Picea Omorika*, which I have found to grow remarkably well in suitable parts of this country. Messrs. Little & Ballantyne, of Carlisle, and Messrs. Kent & Brydon, of Darlington, also sent excellent exhibits. Mr. George Marshall, whose valuable services to the Society in connection with the Forestry Exhibition can hardly be overpraised, showed in this class an interesting set of specimens cut from his plantations near Godalming, showing the comparatively rapid growth of Japanese as compared with common larch. I should, however, like to warn intending planters of Japanese larch that though it may during youth surpass the common species and resist disease better, yet it is extremely doubtful whether it will maintain its superior rapidity of growth as it gets older, or ever attain the same size; whilst it certainly enjoys in its own country a superior soil and climate to that of England. I do not, therefore, anticipate that it will prove as valuable a tree for economic planting as many people at present expect.

Sir Montagu Cholmeley showed a collection of rods for basket making, and I hope this industry which in many parts of the country is being severely handicapped by foreign

importations, may still be found profitable enough in the Eastern Counties to justify the extension of Willow cultivation.

In Section 3 the Duke of Wellington's Forester and Mr. Havelock showed really admirable series of photographs, taken I believe in both cases by themselves, of trees and plantations, and Mr. Richardson sent his well-known photographs of the giant brown oaks, which he has done so much to make famous.

In Section 4, Timbers, &c., one of the most remarkable exhibits was a section of a Spanish chestnut tree from Burghley, two hundred years old, showing that in some districts at least this durable and valuable timber attains maturity without becoming shaky, a defect which immensely decreases its value in most places unless cut when quite young. Lord Egerton of Tatton showed a collection of twenty-five kinds of British grown woods, which I hope he will forgive me for saying were spoilt by a coat of varnish which hid their natural colour. Lord Yarborough's collection of home-grown wood, on account of the great number of kinds (no less than eighty boards being shown), their correct nomenclature, and the skill and care which had been taken in their selection and preparation, was of quite unusual excellence, and should do much to encourage the owners of estates to utilise their own timber for many ornamental purposes for which foreign wood is now generally preferred. Among the less known woods which I specially admired were those of the Portugal laurel, the American black cherry, the bird cherry, the crab-apple, and the medlar. If such a collection of fine woods can be shown from North East Lincolnshire, where the soil and climate are by no means favourable to the growth of many exotic species, what might not be done by the owners of great estates in the more favoured counties of the south of England, where many American and other hard woods producing ornamental timber grow very well?

In this class there were several other exhibits of interest, but the one from Messrs. Wisden showing the manufacture of Cricket Bats was insufficient to educate the would-be grower of the valuable close barked willow in this still somewhat mysterious question, which I do not think will be fully understood unless some distinguished cricketers will come to our help, for those I have consulted seem to judge a bat rather by its balance and its feel in the hand, than by the wood of which it is made, and it is quite possible that some of the willows which at present are not of high value, might prove to be as good or nearly so, if grown under the same condition.<sup>1</sup>

In Section 5, Insects and Diseases affecting Trees, many valuable specimens were shown by the Board of Agriculture

<sup>1</sup> A very interesting paper on this subject has just been published in the *Kew Bulletin* (No. 8), and should be consulted by all those interested.

by the Royal Agricultural Society, and other Exhibitors, though my time, and I think that of most visitors to Lincoln, was insufficient to give them the attention which they deserved.

Section 7, Tools, Instruments, and Appliances. This section has not as yet attracted the attention of manufacturers and inventors in England. I venture to think that there is much room for improvement in the appliances used for felling, moving, and hauling timber, and that in this respect, and also in the appliances used for labelling, marking, and measuring trees, we are still far behind some foreign countries.

H. J. ELWES.

Colesborne, Cheltenham.

---

## FARM PRIZE COMPETITION, 1907.

THE Farm Prize Competition, held in connection with the Society's Show at Lincoln in 1907, revived a series of competitions held from the time of the Oxford Meeting of 1870 down to and including that of 1892 at Warwick.

From the commencement, the Prize money was, as a rule, subscribed locally, with occasional supplementary contributions from the Society. The cost of adjudications, which varied widely from year to year, according to the number of entries, the number of judges required, and the accessibility of the competing farms, was borne by the Society itself.

In 1892, when almost every county had been visited and reported on, the question of the continuance of these competitions was reconsidered, and, after due deliberation and discussion, the Council decided that the Farm Competitions should cease. During the period of their existence, and subsequently, many opinions as to their great practical benefit had been expressed, and so it was that the decision of the Council to renew the Farm Prize Competitions in connection with the Society's Meeting at Lincoln in 1907 met with widespread satisfaction. This decision was largely brought about through the generosity of Sir Richard Cooper, Bart., and the members of the Belvoir, Blankney, Brocklesby, Burton, and Southwold Hunts, who offered the prizes in the various classes.

The competitions advertised were as follows:—

### PRIZES OFFERED FOR THE BEST-MANAGED FARMS IN LINCOLNSHIRE.

CLASS I.—For the best-managed Arable and Grass Farm exceeding 300 acres. First Prize, 60*l.* Second Prize, 30*l.*

CLASS II.—For the best-managed Arable and Grass Farm of over 50 acres and not exceeding 300 acres. First Prize, 35*l.* Second Prize, 25*l.*

*Prizes offered for the best-managed Farms regularly hunted over by the Belvoir, Blankney, Brocksley, Burton, and Southwold Hounds.*

**CLASS III.**—For the best Arable and Grass Farm exceeding 300 acres. First Prize, 30*l.* Second Prize, 25*l.* Third Prize, 20*l.*

**CLASS IV.**—For the best-managed Arable and Grass Farm over 50 acres and not exceeding 300 acres. First Prize, 25*l.* Second Prize, 20*l.* Third Prize, 15*l.* Fourth Prize, 15*l.*

In Classes 3 and 4 the prizes having been given by the Hunts, the use made of wire, and the care taken to remove this danger in the hunting season, was considered by the Judges. In addition to the above, Special Prizes were also given by the Belvoir and Blankney Hunts for the best-managed Farms within the confines of the respective Hunts. A competitor in Class 1 or 2 might, if eligible, enter in Class 3 or 4 (Hunt Prizes), but in the event of winning a prize in Class 1 or 2 was not eligible to take a prize in Class 3 or 4.

The Prize money for Classes 1 and 2 (County Classes) was provided by Sir Richard Cooper, the members of the combined Hunts providing the prizes for Classes 3 and 4. The cost of judging the whole of the farms was also generously undertaken by Sir Richard Cooper, thus enabling the Farm Prize Competition of 1907 to be carried out free of cost to the Society.

On former occasions it has been customary to give a brief general sketch of the leading features of agricultural interest which characterise the particular district under review, but as these features were so ably and exhaustively dealt with by Mr. Frederick Cooke in 1888, when Lincolnshire last came into the Farm Competition area, it is not considered necessary to repeat them here.<sup>1</sup> The following figures may nevertheless be of interest as showing the difference between the areas under the various crops in the county of Lincoln in 1907 as compared with 1887:—

Under the total of "Crops and Grass" there are in the county 6,431 more acres accounted for than was the case in 1887. There are, however, 27,183 acres less "arable" land and 8,600 acres less under the heading of "hay," whereas under "grazing" there is an increase of 42,214 acres. Of the corn crops, wheat has gone out of cultivation to the extent of 69,083 acres, while all the other cereals have increased in area to the following extents: barley 8,984, oats 18,861, rye 2,217, beans 7,435, and peas 4,320 acres. These increases do not, however, make up the deficiency caused by the wheat crop, so that we find an area of 27,266 acres less under "corn" than was the case in 1887.

Of other crops, potatoes show an increase of 17,469 acres, mangold 4,167, carrots 550, cabbage 837, lucerne 870, small fruit 1,704, clover hay 10,988, other crops 5,126, making a total of 41,711 additional acres under these crops. On the other hand, the area under "turnips" is diminished by 24,366

<sup>1</sup> Journal R.A.S.E., 1888, page 510.

acres, kohl-rabi 359, rape 1,456, vetches 364, flax 248, clover (not for hay) 7,296, bare-fallow 7,539, making a total of 41,628 acres. By deducting the difference (83 acres) between these last two totals from the 27,266 acres shown as being less under "corn," we arrive at the original figure of 27,183 acres which have ceased to be under the plough. If we continue the comparison in regard to stock we find that the total of horses shows an increase in the twenty years of 6,374, cattle 14,125, pigs 23,781, whereas sheep have decreased in Lincolnshire by no less than 259,363, or 20 per cent. A closer consideration of the above figures—which, however, would not come within the scope of the present report—might provide much food for reflection.

It has to be observed that the Prize Farm Competition of 1907 was in all classes limited to tenant farmers paying a *bonâ fide* rent for at least three-fourths of the land in their occupation. Competitors were required to enter for competition all the land in their occupation in the district, always provided that such land had been in their occupation for not less than two years.

The following gentlemen were entrusted with the task of judging the farms:—

For Classes 1 and 3 (farms above 300 acres)—Mr. Teasdale H. Hutchinson, Manor House, Catterick, Mr. A. Stretton, Manor House, Sibthorpe, near Newark.  
For Classes 2 and 4 (farms over 50 acres and not exceeding 300 acres)—Mr. R. B. Burrows, Leadonham, Lincoln, Mr. Robert Fisher, Leconfield, Beverley.

The Judges were instructed to take into consideration any special advantages which one competitor might possess over another, to withhold the prizes in the absence of sufficient merit, and especially to consider the following points:—

1. General Management with a view to profit.
2. Productiveness of Crops.
3. Quality and suitability of Live Stock, especially that bred upon the Farm.
4. Management of Grass Land.
5. State of Gates, Fences, Roads, General Neatness and State of Cottage or Cottages so far as tenant is liable.
6. Mode of Book-keeping followed (if any).
7. Management of the Dairy and Dairy Produce, if Dairying is pursued.
8. The duration of the tenancy.

The Competitions were well advertised throughout the length and breadth of Lincolnshire, with the result that the following numerous entries were secured:—

For Class I. 41 Farms.  
For Class II. 49 Farms.  
For Class III. 40 Farms.  
For Class IV. 53 Farms.



The fact that the majority of the farms entered in Classes 1 and 2 were eligible for—and competed in—Classes 3 and 4 respectively, caused considerable duplication of entry ; so that the actual number of farms to be visited by the Judges in Classes 1 and 3 was 45, and 64 in Classes 3 and 4, these figures being eventually reduced by withdrawals to 44 and 61.

Never had there been such an entry for the “Royal” Farm Prize Competitions, and it exceeded even the most sanguine expectations. No doubt the fact that no entry fee was charged had much to do with this, but equally there is no doubt as to the general interest aroused and the keenness of the competitors.

Mr. Teasdale Hutchinson, whose experience of Farm Competitions is considerable, writes :—

“I suppose that no Farm Prize Competition has ever proved a greater success than the ‘Royal’ Farm Prize Competition of 1907. The prizes offered were liberal, and the Lincolnshire farmers entered thoroughly into the spirit of the thing, consequently the entries were large, the interest great, and the competition keen. Undoubtedly the county farming has benefited by the Competition, many neglected buildings have been put in order, gates either renewed or repaired, fences put straight, ditches cleaned out, and quantities of paint applied to houses and buildings that would not otherwise have been used. The land has been better cleaned, better tilled, and many improvements made. Certainly the giving of Farm Prizes is expensive owing to the great cost of going from farm to farm to judge them, but I doubt if there is any other prize given that does more for the improvement of agriculture.”

The Judges arrived at Grantham on Monday evening, March 4, 1907, and were met by Sir John Thorold, Bart. (a Trustee of the Society), and Sir Gilbert Greenall (Honorary Director). Mr. Cyril Greenall—who had up to this time undertaken the task of arranging the itineraries, the motor-car services, and the hotel arrangements—and Mr. W. H. Hogg, of the Woburn Experimental Farm, who had been appointed Secretary to the Competition, were also present. The general scheme of the Competition having been fully explained, and final counsel given, the Judges were left to their arduous duty of inspecting the many farms entered in the various classes. Work commenced the next morning and continued day by day until Saturday, March 23, by which time all the farms had been visited. This was accomplished only by means of hard and long days’ work, the excellence of the motor-car service, and the kindly consideration of the competitors themselves, who placed every facility at the disposal of the Judges. The general plan adopted was to inspect first the

homestead, including all the "live and dead" stock thereat, afterwards taking the fields and any further stock on the farm. The state of the fields cropped in the autumn received attention, as also any remaining portion of the root crops grown in 1906 and their disposal. In this connection it may be interesting to note that it is not customary in Lincolnshire to pull the swede turnips and put them into heaps. The swedes are left in the ground until required, when, the sheep being folded on, the requisite quantity is pulled and "cut" to them from day to day. The idea is that the roots come cleaner off the ground than out of the heaps, and who shall challenge the great Lincolnshire flock masters as to their management of sheep? But "Jack Frost" is a fickle personage whose fancies in the early part of 1907 will be long remembered by root growers in the county. It was a sad sight to see row after row of what were once well-grown swedes red uced to a mass of putrid pulp. Consideration was also given to the preparation of the land for the spring-sowing of cereals, roots, and other crops, and the state of the gates, fences, roads, ditches, and cottages, so far as the tenant is liable, &c., was noted in passing. The Judges were in all cases accompanied by the competitors, to whom their thanks are due for information readily given. The result of this first visit was to reduce the Competition to much smaller compass, the Judges considering that it would be necessary to re-visit the following farms only:—

**CLASSES I. AND III. (FARMS EXCEEDING 300 ACRES).**

Competitor's Name	Entry
W. Banks . . .	County, Combined Hunts, and Belvoir Special.
C. Bowser . . .	County only.
J. Casswell . . .	County and Belvoir Special.
J. Evens . . .	County and Combined Hunts.
H. Minta . . .	County, Combined Hunts, and Belvoir Special.
T. Phillips . . .	County only.
J. Robinson . . .	County and Combined Hunts.
W. Searby . . .	County and Combined Hunts.
L. W. Stephenson . . .	County and Combined Hunts.
J. Todd . . .	County, Combined Hunts, and Blankney Special.
E. Allen . . .	Combined Hunts and Blankney Special.
T. Barraud . . .	Combined Hunts and Belvoir Special.

**CLASSES II. AND IV. (FARMS OVER 50 AND NOT EXCEEDING 300 ACRES).**

Competitor's Name	Entry
E. Burkitt . . .	County and Combined Hunts.
F. Fisher . . .	County, Combined Hunts, and Belvoir Special.
E. Glassup . . .	County and Belvoir Special.
Hensman & Son . . .	County and Combined Hunts.
C. Kent . . .	County and Combined Hunts.
W. Mosher . . .	County, Combined Hunts, and Blankney Special.

Competitor's Name	Entry
G. Petchel . . .	County and Combined Hunts.
E. Turton . . .	County and Combined Hunts.
J. Shaw . . .	County only.
L. P. Stephenson.	County and Combined Hunts.
W. Bray . . .	County only.
R. Cooper . . .	Combined Hunts and Belvoir Special.
W. Potter . . .	Combined Hunts and Blankney Special.
Clark Robinson .	Combined Hunts only.

It must not be inferred, however, that many of the other farms were lacking in those considerations which characterise good farming. This was by no means the case. That the task of the Judges was no sinecure will readily be understood when it is remembered that Lincolnshire has been described as the premier agricultural county of England. It is noted alike for its "good land well farmed" and its diversity of farming, the latter being due, no doubt, to the immense variety of soil. Throughout the county are to be seen flocks of the famous Lincolnshire Long-wool breed of sheep, which has now established itself in all quarters of the globe, herds of the Lincolnshire Red Short-horns, now so well known for their size and substance, and the Lincoln "Curly" pig, a sturdy variety of the "White" with a wonderful capacity for putting on weight. The Judges had carefully to consider each farm point for point in view of the general conditions under which the awards were to be made, and having done so, to decide which should be left in for further inspection. This they did without fear or favour, and decided upon those already mentioned. The second tour of inspection began on Monday, June 10, and ended Saturday, June 15, it being devoted to a closer investigation all round, besides affording a better insight as to the probable productiveness of the crops, the summer management of stock, and the general disposal of the farm.

After due deliberation the Judges made the following awards:—

#### FARM PRIZE COMPETITIONS.

Open to *bonâ fide* Tenant Farmers.

CLASS I.—For the best-managed Arable and Grass Farm, in the County of Lincoln, exceeding 300 acres. First Prize of 60*l.* to John Evens. Second Prize of 30*l.* to John Todd. Reserve No. to William Searby. Very Highly Commended, H. B. Minta and J. Robinson. Highly Commended, J. E. Casswell and L. Stephenson. Commended, W. Banks.

CLASS II.—For the best-managed Arable and Grass Farm, in the County of Lincoln, over 50 acres and not exceeding 300. First Prize of 35*l.* to E. J. Turton. Second Prize of 25*l.* to William Bray. Reserve No. to Henry Neesham. Highly Commended, E. Burkitt, E. Glassup, and J. Shaw.

CLASS III.—For the best-managed Arable and Grass Farm, regularly hunted over by the Belvoir, Blankney, Brocklesby, Burton, or Southwold Hounds, exceeding 300 acres. First Prize of 30*l.* to William Searby.

Second Prize of 25*l.* to John Robinson. Third Prize of 20*l.* to H. B. Minta. Reserve No. to E. G. Allen. Highly Commended, L. W. Stephenson. Commended, W. Banks and T. Barraud.

CLASS IV.—For the best-managed Arable and Grass Farm, regularly hunted over by the Belvoir, Blankney, Brocklesby, Burton, or Southwold Hounds, over 50 acres and not exceeding 300 acres. First Prize of 25*l.* to Henry Neesham. Second Prize of 20*l.* to R. C. Cooper. Third Prize of 15*l.* to Edward Burkitt. Fourth Prize of 15*l.* to L. P. Stephenson. Reserve No. to C. Hensman & Son. Highly Commended, F. Fisher.

*Belvoir Hunt Special Prize.* Farms over 300 acres.—First Prize to H. B. Minta. Second Prize to J. E. Casswell. Reserve No. and Silver Medal to Thomas Barraud.

*Belvoir Hunt Special Prize.* Farms under 300 acres.—First Prize to R. C. Cooper. Second Prize to Edwin Glassup. Reserve No. and Silver Medal to Fred. Fisher.

*Blankney Hunt Special Prize,* for the best Farm in the Blankney Hunt which has not won a Prize in Classes 1 and 3, to E. G. Allen.

*Blankney Hunt Special Prize,* for the best Farm in the Blankney Hunt which has not won a Prize in Classes 2 and 4, to W. H. Potter.

#### CLASS I.—FIRST PRIZE FARM.

(Farms exceeding 300 acres.)

*Occupied by Mr. John Evens, Burton Farm, Burton-by-Lincoln.*

This farm is very nicely situated in the village of Burton, which is about two miles north-west of Lincoln. The house is a picturesque old stone residence restored about twenty years ago and converted into a good modern farm-house. The farm consists of 930 acres, 620 of which are arable and 310 in grass. It is held on a yearly tenancy under Lord Monson, and has been in the family, descending from father to son, for almost 200 years, the present holder taking it over twenty-five years ago. Of the 620 acres of arable land some 420 consist of "cliff" land. This soil is a dry light loam on limestone, excellent turnip and barley land and eminently suitable for sheep. It responds well to liberal treatment, and indeed requires it; but, being near the stone, is apt to suffer considerably in dry seasons. The "cliff" land lies very compactly, almost forming a square, which contains two lots of useful farm buildings with the requisite number of cottages. Here the four-course system is adopted: Fallows and roots, barley, seeds, wheat; the rotation not including oats, which, however, are grown on the lower land. An occasional field of "seeds" is kept down for two years to decrease the corn area, while enabling the farm to carry more live stock. There are about 200 acres of low land which are of a varied nature, some being strong, other quite light. The low land consists of a poor sand with a small proportion of clay, and is farmed with a view to producing as much green food and oat straw as possible for the dairy cows in winter; other crops grown being mangolds, cabbages, rape,

lucerne, and tares. Seeds are here allowed to lay down, for three or four years. The land is subject to floods from the high land drainage in wet seasons, so much so that at one time the water was held up for weeks together; but it now drains off in a few days, the drainage having been greatly improved by the cutting of the Witham Outfall at Boston, which, though many miles away, has the desired effect. The grass is ordinarily useful pasture, not at all of a superior nature, and requires a liberal allowance of cake to help it out. The poorer part on the hillside is apt to burn, and the better land below will not feed cattle without the assistance of cake. This low land country seems to have benefited greatly by the manure resulting from the liberal feeding of the dairy cattle, especially the meadow land, this receiving all the liquid manure from the cow sheds. The meadow land also receives a little help every year from the cleanings up of the lamb pens and the farm-yards. Basic slag at the rate of 7 cwt. per acre has answered well on twelve-year-old grass on the cold clay, but gives no return on the sand. In a growing season like 1907 there was everywhere plenty of feed, and it is evident that the system of caking the young stock on the grass is bringing the pasture up to a high state of fertility. The farm generally is not well watered, particularly the hillside grass. The shallow "cliff" wells are apt to run dry in hot seasons, and in 1906 the crop and stock suffered in consequence. The whole farm requires skilful management and good husbandry, and there is every evidence that it receives both, and is improved greatly thereby. The land is very clean and free from twitch and rubbish, the fences are neatly trimmed, the gates in perfect order, and the hedge bottoms on arable land are cleaned out, the whole farm being run for profit in a business-like manner.

The cropping for 1907 was as follows:—Wheat, 128 acres; barley, 137 acres; oats, 38 acres; swedes, 40 acres; common turnips and rape, 78 acres; mangold, 11 acres; cabbage, 4 acres; potatoes, 4 acres; mowing seeds, 71 acres; grazing seeds for sheep, 109 acres.

**Fallows and Roots.**—The portion required for swedes receives eight loads of farm-yard manure per acre sometime during the winter or before the last ploughing. Before the final ploughing, the turnip land is worked down to further the germination of annual weeds. The swedes are water-drilled on the flat in rows eighteen inches apart, a mixture of 2 cwt. of superphosphate and 1 cwt. bone meal being drilled in with the seed. This season's sowing had been delayed by heavy rains, and at the time of the second visit the swedes were just coming up and looked like growing into nice healthy plants.

Water-drilling is now considered old-fashioned, being much more in vogue thirty years ago, but Mr. Evens has always been satisfied with the system and sees no reason to change. The water-drill is usually six feet wide, drilling four rows eighteen inches apart. It has a large body which is almost filled with water once each "round," the artificial manures being also put in. The cup-bearing wheels revolving in the body churn the whole contents up into a sort of liquid gruel, the seed joins this in the coulters about a foot from the ground and all pass into the soil together. Unless the soil is especially dry, this small quantity of added moisture ensures the prompt germination of the seed. Water-drilling is rather expensive because of the narrowness of the drill, the carting of water, and the time occupied in filling. One can drill about eight acres a day with three horses.

**Mangold Seed** is drilled on ridges and receives a very liberal dressing of farm-yard manure with 3 cwt. of mineral artificials as above, and 3 cwt. of salt. After the plants have been singled they receive a further dressing of 3 cwt. of salt mixed with 1 cwt. of nitrate of soda. The mangold crop showed a very full plant, and the ground was beautifully clean.

**Barley** is sown after roots fed off with sheep receiving a liberal allowance of cake, and needs no further manuring. The yield runs from four to five quarters per acre, usually of good quality, but perhaps not so fine in the grain as when the barley follows wheat after two years' seeds. The land was very clean and the crops looked well up to the average, the best crop being from Scotch seed grown for the second year.

**Oats**, like barley, are grown after roots fed off with sheep, or possibly after two years' seeds, and are not specially manured. The oats grown in 1907 were the "Giant Eliza," grown from Norfolk seed, and looked a capital crop. When a second corn crop is taken the land receives a dressing of 2 cwt. of super-phosphate at time of sowing, and the crop is top-dressed later with 1 cwt. nitrate of soda per acre if considered necessary.

**Seeds.**—Particular attention is paid to the young clovers in winter. They are manured with eight to ten loads of farm-yard manure per acre drawn straight from the covered yards. This is done directly after harvest, if practicable, or at any rate during the autumn and winter, the object being to get the clovers as far forward as possible and thus enable them to carry a big head of stock. Mr. Evens is a great believer in the principle that a good plant of clover will be followed by a heavy crop of wheat. The portion of young clovers for grazing is eaten off by sheep receiving cake, as also is the "eddish" of the mown portion. The seed pastures were good, and well stocked carrying the Lincoln ewes and lambs, and in one field

here were fifty useful shearling rams. About two-thirds of the seeds are grazed, the remaining third being mown. The seeds are undersown with the previous barley crop, the mixture being as follows:—

Grazing Seeds.	Mowing Seeds.
7 lb. White Clover.	7 lb. Red Clover.
3 lb. Trefoil.	3 lb. Cow Grass.
2 lb. Alsike.	2 lb. Trefoil.
1 Peck Dwarf Rye Grass.	1 Peck Mowing Rye Grass.
$\frac{1}{2}$ Peck Italian Rye Grass.	

Wheat follows the "seeds" and if these were manured, as they usually are, then nothing further is given except perhaps a little top-dressing in the spring to weak places. Should the young clovers from any cause not have had any dressing, then eight to ten loads of farm-yard manure per acre are put on before ploughing in the autumn. The wheat land was well tilled, the crops hoed and remarkably free from weeds. The variety grown was "Square Head's Master," and the crops were a nice looking lot, being distinctly good for the class of land. The average yield is about four quarters per acre. Taking the corn crops all round they were nice average crops and very clean, but by no means as heavy as many that were seen on the richer lands.

**Manures and Feeding Stuffs.**—It will already have been noticed that the system of manuring here adopted is to apply farm-yard manure twice during the rotation, viz., to the roots and to the seeds. In the case of the root crops, they receive in addition the artificial dressings already mentioned. Apart from this, however, very little artificial manure is used except where necessary to "start" or "touch up" a crop. Notwithstanding the great quantity of the farm produce which is consumed at home Mr. Evens finds it expedient to purchase large quantities of the various feeding stuffs, the bills for "Cake and Artificials" (the latter being admittedly small) amounting to 1,600*l.* per annum, which equals 34*s.* 6*d.* per acre over the whole farm.

**Stock.**—The live stock on the farm at the time of inspection was as follows:—

Horses.	Sheep.	Cattle.
Working . . . 21	Stud Rams . . . 6	Stud Bulls . . . 2
Light Horses . . . 6	Shearling Rams . . . 55	Young Bulls . . . 24
Unbroken . . . 3	Ewes . . . 319	Cows and Heifers
	Gimmers . . . 139	in-milk and in-
	Lambs . . . 382	calf . . . 92
		Young Heifers . . . 40
		Draught Cows . . . 6
		Sucking Calves . . . 28
		<hr/>
<b>Pigs.</b>		
Lincolnshire		
Curly-coated . . . 11		
	<hr/>	<hr/>
	901	192

The horses are of the "shire" type, good-looking, and well adapted for their work. They lie out at grass all night during summer and receive one stone of corn per head per day all the year round, the corn mixture consisting generally of two parts maize, one part oats, one part of either bran or home-grown meals. During winter the horses receive cut oat or barley straw with their corn. A linseed-gruel tub is kept in the stable, each horse receiving a good helping thrown over its "feed," the allowance being at the rate of one linseed cake per horse per week. The cart-horses were at one time bred at Burton, but, the grass land not being good enough to grow good bone and substance, the tenant found it more economical to buy horses and keep the land for his cattle. His plan is to buy young horses and break them in, frequently selling them afterwards for town work. Another consideration is that where there is much spring work mares in foal are rather a handicap.

**Sheep.**—The flock, like the farm, has descended from father to son. The sheep are of the Lincoln Long Wool Breed, and are entered in the Flock Book. No ewes have been brought in but all the rams used are bought and include purchases from the best known flocks in the county. While not attempting to breed for the ram market, Mr. Evens produces a good farmer's sheep, the Judges seeing several young rams, not over-fed but in good healthy breeding condition, which, although not of the highest class, were really useful sheep, likely to do well for their buyers. Usually about 350 ewes are kept, a third of which are brought in as shearlings, the draft ewes being fed off. The management of the flock calls for no further comment, than that it is "well-cared for."

**Pigs.**—The pigs were of the Lincoln Curly Breed, well suited for the purpose for which they were kept, viz., to supply the house and the farm labourers.

**Cattle.**—Mr. Evens breeds the best of Lincoln Red Cattle, all of which are entered in the Lincoln Herd Book. These were far and away the best lot and the largest herd of dairy cattle seen by the Judges on any farm. The forty milking cows were a sight which probably cannot be equalled on any other farm in Lincolnshire.

#### HISTORY OF THE BURTON HERD.

Lincoln Red Short-horns have been bred for many generations on the Burton Farm, but up to 1885 the ordinary custom of the district was followed, viz., breeding and rearing; the steer calves were grown on for beef, the young cows reared their own calves, and were sold at about the third calf to go into own dairies. In 1885 the present owner of the herd decided



to take advantage of the nearness of Lincoln to start dairying. Selecting, to commence with, the best bagged cows in the herd, he has added other deep milking cows from time to time. Beginning on Monday, March 23, 1885, the morning and evening milk from every cow was weighed and recorded. This system has been continued up to the present day, and for the last sixteen years yearly milk records of the herd have been published. This means a marvellous number of figures, but it has been of the greatest value; cows yielding below a certain quantity of milk are rigorously discarded, and their offspring sold. The ideal aimed at has been milk, combined with size, quality, and constitution.

**Showing.**—The first cow shown in competition was at the London Dairy Show, October, 1887, when "Beauty" won 1st prize in the Shorthorn Milking Trials, and the Lord Mayor's Champion Cup as the best milker in the Show. This early encouragement seems to have induced further showing, which has been continued from year to year with conspicuous success. The Burton Herd have over and over again won chief prizes in the keen competition of the Milking Trials and Dairy Classes at the "Royal" and other leading Shows of England and Ireland, these successes being again repeated in 1907 at the "Royal," Tring, and London Shows.

**Bulls.**—After Mr. Evens started dairying one of the first bulls used was "Beauty Bull" 1770, from "Beauty," the cow mentioned above. The owner firmly believes that "like produces like," and has satisfied himself that in breeding for milk "the bull is half the herd," nay, more, he believes that the sire has more influence in transmitting good dairy properties to the produce than has the dam.

**Selection.**—By keeping milk records, by weeding out indifferent milkers, by using only bulls from cows of "proved dairy merit," the owner has succeeded in building up a large herd of dairy cattle which many visitors have been good enough to describe as "The best herd of dairy cattle they ever saw." The female calves are kept in good natural condition in order to replenish the herd. Many have been sold for abroad and the home counties, but the owner steadfastly keeps to his determination to retain the best at home. The male calves are all kept for bulls and sold privately at about a year old; for these there has been a ready demand. Besides going largely into our own dairy counties, many have found their way to Canada, South Africa, New South Wales, British Columbia, South America, Sweden, &c. A Pedigree Herd Book is kept showing the breeding and ultimate destination of each animal. Mr. Evens has now got together a herd of some 200 cattle that stand second to none in the kingdom, and at the

present time there are at Burton no less than thirty-seven breeding cows and heifers that have won prizes in public milking trials and dairy classes. The produce of some forty cows is sent to Lincoln twice daily. The cow sheds, though adapted from old buildings, are well paved and brought as far as possible up to modern requirements. Water is laid on between each pair of cows. The whole place is kept clean and in a thoroughly sanitary condition, and it is always open to inspection. There are frequent visitors from the various dairy counties of England, and from the Continent and other parts of the world. Mr. Evens claims that he has demonstrated that, with a judiciously selected herd of Lincoln Reds, a tenant-farmer can pay his rent and breed cows that will combine milking capacity with good beef producing qualities.

**Management of the Herd.**—Mr. Evens's system of managing the herd is to keep all male calves entire, and should an odd one appear that is not quite up to the standard he is promptly sent to the butcher. It is rather a difficult problem to know how to keep up the milk production and yet introduce alien blood. The method adopted by Mr. Evens is to buy one or two of the best pure-bred dairy cows in order to breed his own stud-bulls. Of course he runs the risk of sex, but nevertheless he finds this method more satisfactory than any other. The system of cow feeding is also interesting. In summer it is as follows: In May and June, if there is an abundance of grass, an allowance of about 2 lb. cotton cake is given, and later, should grass be scarce, an additional 3 or 4 lb. of mixed meal or bran is allowed; either cabbage or lucerne being thrown into the fields. If possible the cows are given a change of pasture towards autumn, and as this season advances the cabbage is increased to 40 or 50 lb.; later, cabbage is replaced by swedes, for which mangold is substituted after Christmas, or as soon as ripe.

The winter ration is:—

- 4 lb. Cotton Cake.
- 2 lb. Malt Coombs.
- 2 lb. Dried Grains.
- 2 lb. Bran.
- 3 lb. Mixed Meal, generally oats and wheat.

Food oat-straw chaff is also given, long hay once a day, water always being kept before the stock.

**Method of Feeding.**—The grains, coombs (steeped for twenty-four hours), bran, and meals, with a very few pulped roots, are mixed with good oat-straw about twenty-four hours before feeding. A few handfuls of salt are thrown in. The mixture must not be allowed to ferment, otherwise the milk will taste. The cows receive two feeds of this per day and one feed of

ong hay at night to enable them to raise the cud. The cake is given dry, and roots and cabbages are given twice—morning and afternoon.

**Buildings.**—These are maintained by the landlord and consist of four sets fairly up to date and convenient. Two of these—more old fashioned—are being improved by the landlord, who is also adding covered yards.

**Implements.**—The farm was well supplied with good implements all of which appeared to be well looked after.

**Fences, Gates, and Occupation Roads** are maintained by the tenant and all were in good order.

**Drainage** had been much improved, the landlord finding the tiles, the tenant the labour.

**Book-keeping.**—The books kept consist of Labour Book, Cash Book, and Ledger, also the necessary Stock Books and Milk Registers. Mr. Evens considers that so long as a farmer keeps a record of his transactions which will enable him to strike a balance in "Profit and Loss" Account he does all that is necessary.

**Costs.**—Mr. Evens has kindly supplied the following items of expenditure per acre taken on a twelve years' average, and these serve to indicate the thorough system of farming pursued. Rent, 30s. ; Rates, 3s. ; Labour, 28s. 6d. ; Cake and Artificial Manures, 34s. 6d. ; Tradesmen's Bills, 10s. ; Sundries, including stock bought, 14s.

In concluding this description of Burton Farm it is impossible to refrain from speaking of Mr. Evens in the highest terms as being a thoroughly practical, methodical, and business-like farmer. It was a real pleasure to see land so clean and so well cultivated, and to look over such an excellent collection of stock. The whole farm was in splendid order and productive to its utmost capacity—a fact sufficiently evident to the Judges without any perusal of the well-kept and carefully audited books. Everything was neat and tidy, the gates, fences, and roads, &c., were all that could be desired, and the management of the dairy excellent. The lesson here taught is to farm well, and the Judges had great pleasure in awarding to Mr. Evens the First Prize of 60*l.* in the County Class, a pleasure afterwards enhanced by the knowledge that his success had met with the kindly appreciation in tangible form of his landlord, Lord Monson. Both had good reason to be proud.

#### CLASS I.—SECOND PRIZE FARM.

(Farms over 300 acres).

*Occupied by Mr. John Todd, Kirkby Green.*

For the last twenty years Mr. Todd has farmed two separate holdings on the estate of the Right Hon. Henry Chaplin, M.P.,

one consisting of 310 acres at Kirkby Green and the other of 481 acres at Scopwick, making a total of 791 acres, of which 621 are arable. Kirkby Green is a small village three-quarters of a mile west from Scopwick Station, and is united with a village of the latter name as an ecclesiastical parish.

The soil is of moderate quality only, consisting of sandy loam and "thin" land with limestone underneath. The Scopwick holding in particular being all poor thin heath land with not more than six inches of soil, which, however, will grow good roots and fine quality barley.

The ordinary four-course system of cropping is adopted, viz., turnips, barley, clover, wheat.

The grass land, in addition to dressings of farm-yard manure, has all been treated with artificials during this tenancy with beneficial effect. The artificial mixture used was 5 cwt. basic slag plus 3 cwt. kainit per acre; but Mr. Todd now uses 4 cwt. per acre basic superphosphate only. The grass also benefits greatly in the spring through being run over by ewes and lambs consuming mangolds and cake. The hay crops this year were very good.

Cropping in 1907 was as follows: barley, 147 acres; wheat, 86 acres; turnips, 108 acres; mangolds, 30 acres; seeds, 183 acres; oats, 58 acres; cabbage, lucerne, &c., 9 acres.

All the farm-yard manure made in the yards is applied to the "seeds," and this works out at about eight loads per acre, following which a white crop is taken. After the white crop the land is cleaned and sown with roots, most of which are fed on, thus dressing the ground for the succeeding crop of barley. The sheep which are folded on receive from  $\frac{1}{2}$  lb. to 1 lb. of cake per head per day. The barley land before being "drilled" is dressed with salt at the rate of 3 cwt. per acre, with the occasional addition of 2 cwt. superphosphate per acre. Wheat receives a similar dressing with the addition of 1 cwt. nitrate of soda per acre applied in the spring. Land coming in for roots receives 3 cwt. of kainit per acre as early as possible in the spring, and at sowing-time a dressing of 4 cwt. basic superphosphate per acre.

The working horses, twenty-two in number, were a very useful lot indeed, twelve of them being entered in the Shire Stud Book. There were also five yearlings and five foals all of good stamp and likely to turn out well. The horses run out to grass at night all the summer and have about one stone of corn per head per day all the year round, with straw chaff and oil cake, the latter being given in the form of gruel.

**Cattle.**—Between sixty and seventy head of Lincoln Red Short-horns are summered each year for breeding. At the

time of visiting the farm, there were to be seen twenty-seven cows, nine of which were in milk, the other eighteen each suckling a calf, four of these being bull-calves; there were also six young heifers running with the bull, six eighteen-month-old heifers, four yearling bulls, and five yearling steers. Mr. Todd does not make a practice of showing, but one cow, "Kirkby Nonpareil," has won five first prizes, three of which have been at the "Royal." Several of the bulls bred on this farm have proved to be very successful sires, amongst them being "Kirkby Virtuoso" and "Kirkby Middle Marsh 2nd;" this latter bull, after being used in one gentleman's herd for eight years, was disposed of by him for fifty-two guineas. The bull calves are sold at ten and sixteen months old at the Alford and Lincoln Fairs, the steers and draft cows being fattened off. About 120 beasts are wintered annually. The "stores" receive 3 to 5 lb. of cake per head per day with straw and hay, and those put up for "fattening" are given 6 to 7 lb. of cake with roots, straw chaff, meal, and hay.

**Sheep.**—The sheep are of the Lincoln breed and all entered in the Flock Book. Usually 230 ewes are kept. At the time of our visit there were 213 ewes, 164 single lambs, 53 pairs, and 70 gimmers. About seventy gimmers are brought into the flock each year to take the place of the draft ewes which are fattened off. A number of gimmers and some ram hogs are each year sold for breeding and exportation. Usually 1,000 sheep are wintered on the roots, receiving cake as mentioned above, but this last winter there was 1,200. Half-a-dozen breeding sows of the Lincoln curly breed are kept to eat up the offals, &c., and supply the household and labourers, and some of the pigs are sold off "fat."

**Feeding Stuffs and Manures.**—In addition to the farm produce consumed at home, amounting to 250 quarters, the following expenditure, taken from a twenty years' average, is incurred annually: Cakes, 700*l.*; other feeding-stuffs, 484*l.*; artificial manures, 256*l.*; or a total annual outlay of 36*s.* 5*d.* per acre all round, exclusive of the value of the home produce. The farm was well supplied with good buildings, and during this tenancy the landlord has covered in six yards and erected "waggon" sheds and other conveniences. The tenant is responsible for the necessary painting and repairing of the buildings, but usually considerable assistance has been received from the landlord.

**Drainage.**—After Mr. Todd entered into occupation the landlord undertook the necessary drainage, this extending to about 100 acres, the tenant being called upon only for the carting of the tiles.

**Labour.**—The rate of pay for labour in this district is not so high as in some parts of the county, the daily wage averaging 2s. 6d. per day. Much of the work, however, is let out by the piece, thus giving the men an opportunity of earning good wages. One or two of these prices may be interesting. For hedge-topping (which is done twice a year) 1½d. per chain is paid; turnip hoeing, 6s. 6d. per acre; pulling mangold and putting into carts, 8s. per acre.

**Harvest Work.**—The wage paid for stooking, raking and tying rakings, is 1s. 6d. per acre; pitching, 7d. per acre. All the other men at work on the harvest receive per head a similar amount to that earned by the pitcher; thatching being paid for at 1d. per square yard. The farm is well supplied with cottages. The foremen and shepherds live rent free, the labourers pay 1s. 9d. per week, and receive in addition to the garden a rood of potato land on the farm, for which Mr. Todd supplies the horse work and manurè, the labourer providing the seed and necessary labour. The labour account, exclusive of blacksmiths and joiners, averages 966l. per annum. No record is kept of the different costs as between arable and grass land.

**Book-keeping.**—A complete record of receipts and payments is kept, and these are transferred to the ledger under the different headings—Horse, Cattle, Sheep, Pigs, &c. The present state of the farm reflects the greatest credit on the tenant. It was evident to the Judges that the land was of a poor hungry character which would soon fall away if not constantly kept up to pitch by liberal feeding of cattle and folding of sheep. On the other hand, the land is not altogether greedy, the crops seen bearing excellent testimony to the liberal and judicious expenditure in fertilisers and feeding-stuffs which Mr. Todd annually incurs. The poor grass land has been much improved, and is now repaying the attention bestowed upon it. All the arable land was well cultivated, and the crops were remarkably good considering the nature of the soil.

The horses, cattle, and sheep were all good and of the recognised Lincoln breeds, being entered in the respective 'books.' The homestead and buildings were extremely well kept, everything being neat and tidy; there was a place for everything and everything was in its place. The last few years have not been particularly favourable for heath land farming, and it must have been very disappointing to go on spending money year after year with so little return; but reward comes at last, and those of the heath farmers who, like Mr. Todd, were not disheartened but continued doing their land well will have the satisfaction of knowing that they were able to show the Judges crops that to all appearance should give bumper yields when a suitable season comes.

## CLASS II.—FIRST PRIZE FARM.

(Farms under 300 acres.)

*Occupied by Mr. E. J. Turton, Horkstow.*

This farm is situated at Horkstow, a pleasant village four miles south-west from Barton station and nine miles north from Brigg. It consists of 195 acres arable and 95 acres grass, and is owned by the Right Honourable the Earl of Yarborough.

**Soil.**—Half the arable land is on the "Wolds," on limestone, and the other half, as well as all the grass land, is in the "Cars" and very heavy. All the land is in good heart and on the level with the exception of one field of grass which is on a very steep hill separating the "Wolds" and the "Cars."

**Cropping.**—The "Wolds" land is farmed on the four-course system, viz., turnips, barley, seeds, wheat (or oats), and the "Car" land on a five or six-course, viz., fallows, wheat, seeds, oats, beans, wheat, the wheat being undersown with five pecks best Italian rye grass. The latter is grazed until the following June, and is then broken up for fallows.

**Management of Grass.**—Ten acres of the grass land are dressed every autumn with 7 cwt. basic slag, which has a very beneficial effect. Store hogs fed on mangolds, with cake, &c., are folded on another portion, the effect on the grass being wonderful. The meadow land is dressed with six loads per acre of spit dung (dung from the heap) every winter on half the field, and the remainder has 1 cwt. nitrate of soda and 2 cwt. superphosphate applied early in April, the fields being treated alternatively. Basic superphosphate at the rate of 3 cwt. per acre has also been used as an experiment with good effect. The grass this year was most luxuriant and above the average in quantity. The hay crops were heavy and secured in excellent condition.

**Acreage of Crops.**—Wheat, 28 acres; barley, 36 acres; oats, 19 acres; beans, 12 acres; grazing seeds, 40 acres; mowing seeds, 12 acres; roots, 36 acres; bare fallows, 12 acres.

**Fallows and Roots.**—The last corn crop on strong land coming in for fallows (in the "Cars") is sown with five pecks rye grass, which provides an early bite in the spring and carries a large head of ewes and lambs in a most thriving condition till the middle of June. All stubbles on the "Wolds," when coming into fallows, are carefully gone over and any twitch forked out, the land consequently being easily kept in a clean condition.

**Roots.**—**Swedes.**—This crop receives 5 cwt. per acre of a mixture of bone compound and bone meal in equal parts. As an experiment ten acres received 3 cwt. kainit per acre the previous autumn with marked effect, and a further ten acres,

subject to "finger-and-toe," received 2 tons per acre dog-kennel lime four years ago which completely cured the disease, with the result that this field has now a fine healthy crop of turnips.

**Mangolds** are always drilled on the ridge and about two acres of this crop are grown each year. The dressing consists of six loads of spit dung and 3 cwt. of kainit per acre applied in the autumn; a mixture of 3 cwt. superphosphate with 1 cwt. of nitrate soda per acre is added in the spring, half being given at the time of sowing, the other half before the last scuffling. The root crops were all good and distinctly above the average notwithstanding the fact that the portion first sown had suffered from cold and drought. The mangolds were exceptionally good, but like all other crops of this root this year had a great many runners.

**Barley.**—Barley is all grown after roots fed off by fattening sheep and breeding ewes, and is therefore not specially manured. The crops this year were particularly heavy and long in the straw. Hallett's "Chevalier" barley is always grown, fresh seed being obtained each year from Major Hallett.

**Seeds.**—This season's mowing seeds were on the heavy "Car" land, on a portion of which Mr. Turton successfully experimented by dressing it the previous autumn with 7 cwt. per acre of basic slag; the crop and "eddish" on the treated portion being twice as heavy as those on the untreated portion.

The seed mixtures used are per acre :—

For mowing	For grazing
7 lb. red clover.	10 lb. white clover.
7 lb. cow grass.	2 lb. giant white clover.
$\frac{1}{2}$ peck dwarf rye grass.	2 lb. alsike clover.
	2 lb. rib grass.
	2 lb. parsley.
	$\frac{1}{2}$ peck Italian rye grass.
	$\frac{1}{2}$ peck dwarf rye grass.

**Wheat.**—Seven loads per acre of spit dung are applied to the fallows before they are finally cultivated for the ensuing wheat crop. The wheat crops seen were good with an abundance of straw, and looked like yielding a good crop. New seed, "Square Head's Master" and others, is bought every season for the "Car" land and then grown on the "Wold" the succeeding year.

**Oats.**—The oat crop, like the wheat, is manured with seven loads spit dung, receiving in addition 1 cwt. nitrate of soda and 2 cwt. superphosphate per acre during the first week in April. The crops seen were very good indeed.

**Feeding Stuff and Manures.**—About 100 quarters of farm produce is used for home consumption yearly, and, in addition,



some 40 tons of mixed cakes ; about 12 tons of bran and dried grains, &c., are purchased. The average outlay in recent years has been for cake 275*l.*, and for "corn" (bought) 195*l.* Artificial manures run to 40*l.* per annum.

**Horses.**—Seven working horses, two three-year-old colts, and two yearling colts.

**Cattle.**—Twenty-two cows and heifers with twenty-eight calves, five yearling heifers, and five two-year-old heifers.

**Sheep.**—One hundred and sixteen breeding ewes, forty gimmers, 170 lambs, four rams, all pure-bred Lincolns.

**Pigs.**—Seven young stores and seven feeding pigs, one boar.

**Poultry.**—One hundred and fifty hens, fifty pullets, and sixty cockerels.

#### MANAGEMENT OF STOCK.

**Horses.**—During summer the horses run out to grass. In winter they receive an allowance of one stone of "sharps," with a little bran, per head per day, along with cut clover and old oat straw. They also get per head per week one linseed cake, which is made into porridge and served with the cut feed.

**Cattle.**—The cattle are very good and consist of pure-bred Lincoln Red Short-horns, all of which are entered in the Herd Book. About twenty-two cows and heifers are kept, the cows rearing two and the heifers single calves. They are all grazed on grass during the summer with the calves. The best male calves are kept entire, six or eight bulls being sold every spring at the Lincoln April Sale. These young bulls are induced to eat a little cake and crushed oats as soon as possible, and allowed to run with their dams as late as advisable. The remaining calves are weaned in the autumn, six of the best heifers being brought into the herd, and the rest sold as yearlings in the spring. The dams are wintered on barley straw, with an allowance of 4 lb. mixed linseed and cotton cake (equal parts) and a few roots, a foddering of clover being given once a day for a few weeks before coming down for calving. The young holding stock receive 3 lb. mixed cake, a few cut roots, and a little clover once a day all the winter. The yearling calves are allowed 4 lb. mixed cake, a few cut roots and mixed barley and oat straw chaff, with a foddering of hay once a day, the allowance being gradually increased towards sale day.

**Sheep.**—The sheep also are very good, being of the pure-bred Lincoln type and all entered in the Flock Book. The ewes are grazed on new seeds and "eddishes" during summer and are fed on roots in the winter, generally from November 1 to

lambing time, which is about February 20. Forty gimmers are brought into the flock every year, receiving an allowance of cut oat-straw and clover, with  $\frac{1}{2}$  lb. cotton cake per head, as soon as put on to the roots. Lambs are weaned in July and run on clover and grass "eddishes." They are enticed to eat a little cake and corn whilst with the ewes, and have pens made specially separate from their dams. When on grass "eddish" they get cabbage and a few turnips before being finally folded on roots, with an allowance of crushed oats, &c., which is gradually increased to  $\frac{1}{2}$  lb. per head per day in the spring, when all are finished off fat. All the males are kept as rams, and twenty of the best are picked out in the spring, clipped early, and disposed of in the following autumn at good prices. For several years both rams and gimmers have been sold for exportation to Buenos Ayres. All the females are kept, forty of the best being retained in the flock, and the remainder clipped, grazed, and sold the following autumn for breeding purposes. These lately have made very remunerative prices. The remaining ram hogs are clipped before going to market, the last two years' clip of wool has been very heavy, the ewes' and hogs' fleeces averaging a trifle over 14 lb. each, and for many years the hogs averaged more.

**Buildings, &c.**—The farm-house, buildings, fences, gates, and roads are kept in tenable repair by the tenant, the buildings being also insured by him against fire.

**Drainage.**—The landlord finds tiles and the tenant the labour.

**Labour.**—The cost of labour averages about 30s. per acre, the daily wage paid being 2s. 9d. in summer and 2s. 6d. in winter. The harvest work is all let to "get into stack" at 11s. per acre. Turnip hoeing, hedge trimming, and layering are also let. Yearly labourers average about 1l. per week with house and garden, potatoes, and 30 stones of bacon. The foreman receives an additional allowance of 10s. per week each for the board of two lads, together with 30 stones of bacon for each lad, a cow being also allowed. Coal is found for the shepherd during lambing time, and he receives a bonus of 6d. per head for each lamb reared up to weaning time.

**Improvements.**—The tenant stated that this farm was in a very foul and bad state of cultivation when he entered on it thirty years ago, three out of five fields on the strong land "Cars" had to be summer fallowed during the first year, and, owing to the wet summer of 1879, two of them the following year also. The whole of the arable and grass land has been thoroughly drained with 6 in. outfall and 3 in. small drains. This was done twenty-seven years ago and is as good as ever. The effect of this drainage has been most beneficial. **Excepting**

a portion of one field, the arable land on the "Cars" has never had any dung applied, and yet continues to grow good crops of corn simply by the course of cropping adopted with the aid of summer fallowing and artificial manures. The "Wold" land also was in a foul state, but is now remarkably clean; this has been brought about by autumn cultivation and by forking the twitch out of the root crops before the sheep folds, and by forking the stubbles as soon as possible after harvest. The "Wold" land has improved in fertility also during the present tenancy. Originally Mr. Turton had to apply a liberal dressing of dung and artificial manures to secure his root crop, and all the roots grown had to be eaten on the land to ensure getting anything like a crop of barley. Now he can, and does, dispense entirely with the dung, and carts one quarter of the root crop off the land; yet the succeeding crop of barley is always heavy and liable to become badly "lodged."

Several crooked fence drains have now been filled in and new quick planted, and fences which were gappy and overgrown have been layered from time to time, new quicks being put in where necessary.

**Book-keeping.**—A perfect system of accounts is kept showing all receipts and expenditure, including team work, labour, and cropping.

**Conclusion.**—In conclusion it need only be said that the Judges found this farm in an excellent state of cultivation and productiveness, the cattle and sheep being all of the well-known Lincoln breeds and good of their kind. There was evidence of a large yearly outlay on the farm in home-grown produce and purchased foods in the high state of fertility which was everywhere seen. In fact, everything looked well and suitably managed with an eye to at once benefiting the tenant, and leaving everything in a condition satisfactory to the landlord.

#### CLASS II.—SECOND PRIZE FARM.

(Farms under 200 Acres.)

*Occupied by Mr. William Bray, East Keal.*

This Farm is situated in the East Fen district of Lincolnshire and consists of 68 acres arable and 4 acres grass land, and had been in the hands of assignees for some time until the autumn of 1906, when it was purchased by Henry Caudwell, Esq. It has been occupied by Mr. Bray for twelve years at a rental of 100*l.* per annum. The soil is of the black and peaty nature which characterises this Fen land, and the areas under the different crops in 1907 were as follows: Potatoes 8 acres, mangolds 5 acres, barley 5 acres, seeds 14 acres, wheat 12 acres,

oats 14 acres, and peas 8 acres, the remaining portion of the land being taken up by the house, garden, yards, &c. A five-course system of cropping is adopted, viz., oats, wheat, seeds, peas, and barley alternately, then potatoes and mangolds alternately as a fallow crop. Manuring—twelve loads per acre of farm-yard dung are applied to the seeds, which, as stated above, are followed by peas and barley. The same amount of dung per acre is given to the oat stubble and ploughed in for wheat, the stubble having been previously thin-ploughed, dressed off, and burnt. All remaining farm-yard manure goes to the fallow crops, which receive, in addition, the following artificial manures: Potatoes, 4 cwt. superphosphate, with 4 cwt. bone-meal per acre, and the mangolds 2 cwt. superphosphate, with 3 cwt. bone-meal per acre. Nearly all of the farm produce is consumed at home. Straw is used for bedding and fodder, the clover is consumed in the yards by stock with linseed cake and cotton cake. The barley is used for pig feeding, of which class of stock Mr. Bray makes a speciality with great success. The stock on the farm consisted of four horses, thirty cattle, and thirty pigs. The number of horses will appear large for this small farm, but the explanation is that Mr. Bray gets in young horses and makes them up for sale, realising very good prices. Five cows are milked and a similar number of calves reared in the summer. The calves are always "kept up," green food being supplied to them, with a little cake in addition. The cows are given about 8 lb. mixed cake per head daily. About twenty beasts are bought in for winter feeding, and sold off when fat. The Judges considered all the cattle and pig stock excellent, and the horses very good. The farm was in first-class condition and very clean. The wheat, barley, oats, peas, and mowing clover were all exceedingly good-looking crops. The mangold and potatoes were good and without a weed to be seen. The fences and gates were in good order, but the premises are in need of repair. The farm is worked by Mr. Bray with two men and one boy, except at busy times, when additional assistance may be required. Labour wages run at 2s. 6d. per day in this district, and the annual bill for this farm works out at 45s. per acre.

Mr. Bray has not had the advantage of education, and is unable to keep any books, but is, nevertheless, one of those striking instances of sheer merit and force of character which will "come out on top" against all odds. Beginning farm work as a boy he gradually passed through all the various stages of farming life, eventually rising to the position of foreman.

Starting business on his own account in 1876 he purchased 10 acres of land which had gone out of cultivation, and by

dint of hard work, all of which he did himself, this ground was gradually but surely brought into a very productive condition. Meanwhile Mr. Bray did day work and piece work for two neighbouring farmers, thus keeping himself going and saving a little as well. And so things went on until 1895, during which year Mr. Bray took the farm at East Keal.

It was very clear to the Judges that here was an excellent and successful farmer. The whole of the land was in a perfect state of cultivation and beautifully clean, the stock were of good class and well looked after, the whole farm being well managed. In this connection it may be interesting to quote the present landlord's testimony to the effect that during the twelve years of Mr. Bray's occupancy the farm has been improved from "practically out of cultivation" to "perfect order."

It was a very real pleasure to the Judges to be able to award a prize to such a thoroughly industrious and deserving competitor.

#### GENERAL REMARKS.

After having described the winning farms in the two classes open to the whole county, it only remains to be said concerning the commended farms in these classes that they were all—in varying degree—in a good state of cultivation, well farmed, and carrying good crops and stock. To have been selected for a second visit out of so large an entry was evidence of sound practical management, and in other respects clean and creditable farming. Some indeed presented special features which appealed strongly to the Judges, but the tendency—occasionally exhibited—to favour one feature at the cost of others, precluded the consideration as "all round" prize farming. With comparatively few exceptions all the farms in the County Classes were eligible for, and competed in, the Hunt Classes, and vice-versâ ; thus the foregoing remarks may be taken as embracing the Hunt Classes also. It naturally follows that any farm taking a high place in the "Open or County" Class must stand high in the more confined area to which the Hunts are restricted, always provided that due attention were paid to the "Hunt" clause respecting the use of "wire," and the removal of this danger in the hunting season. Hence we find those names which were highly commended in their County Class appearing as the prize winners in the Hunts section. There are, however, one or two whose names appear only in the Hunts list, they having elected to compete in—or being eligible for—that class only.

Farm judging, if thoroughly done, means hard work, particularly with so large an entry, but it is work of a highly

interesting and instructive character. The experience gained in Lincolnshire will long be remembered by those whose pleasure it was to meet the competitors this year.

It is worthy of note that the best farms seen were not bound down to any prescribed form of rotation, but simply farmed in whatsoever manner appeared to the tenant to be most desirable, and these were characterised by good healthy crops and perfectly clean cultivation. Neither "condition" nor "fertility" is likely to suffer with a good tenant under an open agreement. No man realises better than the tenant himself that land in a high condition will not only give him good crops in a good season, but will also be better able to resist a bad one, whereas land impoverished by over-cropping or through lack of proper treatment is incapable of doing either the one or the other.

Clean your land before it's dirty,  
Feed your land before it's hungry,  
Rest your land before it's weary.

The Judges consider that a comparatively small entry fee would have prevented many useless entries, and thus have materially reduced the cost of adjudication. The weather, though variable and at times stormy, never seriously interfered with the work of judging. The motor cars supplied ran well and without accident, notwithstanding the fact that considerably over 1,000 miles were traversed by each set of Judges. Tyre trouble only was experienced, and that merely twice, causing no appreciable delay. How long, one wonders, would it have taken the two sets of Judges to inspect 105 farms under the old conditions, when the local railway and the farm trap were the only means of transport. The Judges were much impressed by the hearty cordiality with which they were everywhere received, and desire to express their sincere thanks to the Competitors for the courtesy and hospitality so kindly extended to them. They especially desire to convey to Mr. Cyril Greenall an expression of their gratitude for the excellent arrangements he so kindly made for their comfort and convenience throughout the tours of inspection.

WILLIAM H. HOGG.

Woburn Experimental Farm,  
Aspley Guise.

We subscribe to the foregoing—

TEASDALE H. HUTCHINSON,  
ARTHUR STRETTON,  
R. B. BURROWS,  
ROBERT FISHER.

**REPORT OF THE COUNCIL TO THE  
ANNUAL GENERAL MEETING OF GOVERNORS  
AND MEMBERS OF THE SOCIETY,**

**HELD AT THE ROYAL AGRICULTURAL HALL, ISLINGTON,**

*On WEDNESDAY, December 11, 1907, at 2 p.m.*

**MR. F. S. W. CORNWALLIS (Trustee) in the Chair.**

1. The Council have to report that the list of Governors and Members has undergone the following changes during the year which has elapsed since the Annual General Meeting in December, 1906: 21 new Governors (of which number 15 were previously Members) and 616 new Members have joined the Society, and 7 Members have been re-instated under By-law 14; whilst the deaths of 3 Governors, 92 Life Members, 154 Annual Members, and 1 Honorary Member have been reported. A total of 31 Members have been struck off the books under By-law 12, owing to absence of addresses; 61 under By-law 13, for arrears of subscription; and 1 Governor and 216 Annual Members have resigned.

2. The Council regret to have to record the death, in April last, of Mr. Albert Pell, of Hazelbeach, Northampton, who for many years was an active Member of their body. Mr. Pell became a Member in the year 1843, and served on the Council from 1886 until 1905. During that period he rendered valuable services on several Committees, including the Journal, Chemical, Botanical, Veterinary, and Education Committees, and he was a constant contributor to the Society's Journal.

3. Amongst other Governors and Members, whose loss by death during the present year the Society has to deplore, are: The Marquis of Bristol, the Earl of Dunmore, Earl Sondes, Earl Winterton, Viscount Goschen, Baroness Burdett-Coutts, Lord Aldenham, Lord Allendale, Lord Chesham, Lord Penrhyn, Lord Thring, Lord A. G. Russell, K.C.B., Lord Percy St. Maur, the Hon. G. H. Allsopp, Capt. the Hon. J. C. Best, the Hon. Mark Rolle, the Right Hon. Evelyn Ashley, the Right Hon. G. H. Finch, M.P., Sir Francis Tress Barry, Bart., Sir J. Colquhoun, Bart., General Sir H. P. De Bathe, Bart., Sir David Gamble, Bart., K.C.B., Sir John D. Milburn, Bart., Sir C. M. Palmer, Bart., Sir Frederick Wigan, Bart., Sir Alfred Billson, M.P.,

Professor Sir Michael Foster (Honorary Member), Sir John Hall, K.C.M.G., Admiral Sir L. G. Heath, K.C.B., Professor R. Warrington, F.R.S., Professor A. W. Williamson, Mr. Paul Aubert (St. Hilaire, France), Mr. Charles Barton, Mr. Richard Bettinson (1852), Mr. Peter Blundell, Mr. Albert Buck (1853), Mr. John Chick (1856), Mr. Newton Clayton, Mr. R. G. Clutton, Mr. S. Copeland, Mr. E. T. Dames-Longworth, Mr. George Littleton Dewhurst, Mr. J. E. Erle Drax, Mr. Septimus G. Foulkes, Mr. T. C. Garth (1842), Admiral R. H. Hamond, Mr. Henry R. Hart, Mr. E. C. Healey (1856), Mr. Richard Hewlins, Mr. Archibald Hunter, Mr. A. D. Hussey-Freke, Lt.-Col. G. S. C. Jenkinson, Mr. H. J. Keyworth, Mr. E. L. Kindersley-Porcher, Mr. George Laing, Capt. J. R. Lane-Fox, Mr. Edgar Lubbock, Capt. W. E. Lockhart, Mr. J. H. Lutley, Col. A. C. McLeay, Mr. Edward Mucklow, Senr., the Rev. T. H. Mynors, Mr. Joseph Perkins, Mr. W. S. Perry, Mr. Ernest Prentice, Mr. Thomas Sample, Mr. Coates Sharpley, Mr. Thomas Smith (Blacon Point, Chester), Mr. F. J. Snowball, Mr. E. J. Stanley, Mr. J. C. Moore Stevens (1846), Mr. C. U. Townsend, Mr. John Watts, and Mr. George White (Hunton, Maidstone).

4. The above and other changes bring the total number of Governors and Members now on the Register to 9,690, divided as follows :—

- 1 Foundation Life Governor ;
- 171 Annual Governors ;
- 91 Life Governors ;
- 6,308 Annual Members ;
- 3,090 Life Members ;
- 29 Honorary Members.

9,690 Total number of Governors and Members, as against a total of 9,620 Members on the Register at the time of the last Annual Report.

5. Owing to ill-health, Sir Charles Whitehead, who had served on the Council since the year 1869, felt it necessary, in July last, to resign office as one of the Vice-Presidents of the Society. To fill the vacancy thus created, the Earl of Yarborough has been elected a Vice-President. Mr. Alfred J. Smith, who was elected a Member of the Council in 1886, has also, through failing health, resigned his seat. The Division of Suffolk which Mr. Smith represented on the Council being one of the Electoral Districts of Group "B," the vacancy caused by his retirement will be filled up in the ordinary course.

6. In order to bring the By-laws enacted under the Original Charter of 1840 into conformity with those enacted under the Supplemental Charter of 1905, the two sets have been



revised and re-numbered with a view of their being issued in future in one pamphlet. The following new By-law (No. 83) was sanctioned at the General Meeting held in the Lincoln Showyard on June 27, and was formally enacted by the Council on July 31 last:—

“ 83. If on the 1st day of August in any year the number of Governors and Members entered in the Register of Governors and Members for any Division shall be such as would, if the regular election of Ordinary Members of the Council for that Division under By-law 82 were due to take place with reference to the next ensuing Annual General Meeting, entitle such Division to a greater number of Ordinary Members of Council than was elected at the preceding regular election under By-law 82, such Division shall (with reference to the next ensuing Annual General Meeting) be entitled to elect such number of additional Ordinary Members of the Council as, with the number already elected, shall make the number of Ordinary Members of the Council for that Division equal to the number prescribed by By-law 79. Ordinary Members of the Council elected under this By-law shall hold office only until the next Annual General Meeting, at which, under By-law 82, the Ordinary Members of the Council for that Division are to retire.”

The effect of this new By-law has been to give one additional representative to each of the Divisions of Lincolnshire and Staffordshire, the number of Members in these two Counties on August 1 last being respectively 375 and 307.

7. The Council are pleased to report that in the early part of the present year they were successful in disposing of Harewood House for the sum of 45,000*l.* This transaction enabled the Society to pay off all the charges on the property and to discharge all expenses incidental to its sale, in addition to the costs attending the occupation of the present house.

8. Under the By-laws, the balance-sheet has to be presented for consideration at the Annual General Meeting. The Council, therefore, beg to submit the balance-sheet for the year 1906 with the Statement of Ordinary Income and Expenditure. These accounts were published in Volume 67 of the Journal issued to Members last March, having been duly examined and certified as correct by the Auditors appointed by the Members, and by the professional Accountants employed by the Society.

9. In accordance with a recommendation of the Special Committee which sat in September, 1905, the Council invited representatives of all the Agricultural and Breed Societies in the country to attend a conference, which was held at the Hotel Russell on February 27 last, and was attended by 139 delegates, representing 68 Societies. Interesting discussions took place with regard to the arrangements and dates for the several Shows, fraudulent practices by exhibitors, and the question of uniform colours for prize cards and rosettes. On the motion of the (late) Earl Winterton, it was resolved to send a Deputation to the Railway Clearing House with the view of

obtaining increased facilities for the Public and Officials traveling by rail to Agricultural Shows. The Deputation was received by the General Managers of the various Railway Companies at the Clearing House on May 7, 1907. The requests of the Conference having been submitted by the President, the Earl of Yarborough, the Chairman of the Meeting promised the careful consideration of the Companies to the requests which had been submitted to them. A letter was, however, subsequently received from the Secretary of the Railway Clearing House, in which it was stated "that, with every desire "to meet the Agricultural and Breed Societies as far as possible, "the Companies are unable at the present time, having regard "to the constantly increasing expenses of railway working, to "grant any further concessions such as those indicated by the "deputation."

10. The Council have much pleasure in announcing that Volume 68 of the Journal will be produced under the Editorship of Major P. G. Craigie, whose assistance they have been so fortunate as to secure.

11. Arrangements having been made for the reception and accommodation of the Society's Library in the New Council Room, the Books have recently been placed in the shelves prepared for them, and a new Catalogue is in course of preparation.

12. The Society's Sixty-Eighth Annual Show, under the Presidency of the Earl of Yarborough, was held on the Carholme at Lincoln, from Tuesday, June 25, to Saturday, June 29. The Farm Prize Competitions which, through the generosity of Sir Richard Cooper and the members of the Belvoir, Blankney, Brocklesby, Burton, and Southwold Hunts, were revived this year, excited considerable interest in the County. Prizes amounting in all to 300*l.* were offered in four Classes, for which no less than 111 different Farms were entered. In addition to providing half the prize money (150*l.*) Sir Richard Cooper was also good enough to defray the expenses connected with the judging of all the Farms in both the Open and the Hunt Classes.

13. Fortunately, the Show was favoured with fine weather, and the number of visitors was very large, those passing through the turnstiles reaching a total of 133,006. This is the largest number recorded since the Cardiff Meeting in 1901, when the attendance was 167,423.

14. The total amount of Prizes offered was 8,516*l.*, of which sum 1,000*l.* was contributed by the Lincoln Local Committee, 139*l.* by the Lincolnshire Agricultural Society, 2,607*l.* by the various Breed Societies, 770*l.* from other sources, the remaining 4,000*l.* being contributed by the Society. The

show of live stock and implements was exceptionally good, and in this connection it is worthy of note that the County of Lincolnshire possesses three distinct breeds, namely, the Lincolnshire Red Short-horn, the Lincoln Long-wool Sheep, and the Lincolnshire Curly-coated Pig, and in each of these sections the Classes and Prizes were augmented by the respective Breed Societies. The same privileges in connection with the Show were accorded to the Members of the Lincolnshire Agricultural Society as are enjoyed by Members of the Royal Agricultural Society. The Lincolnshire Agricultural Society's "one day" Exhibition of Live Stock and Produce was held in the Showyard, on Friday, June 28. His Majesty the King, accompanied by The Grand Duke of Hesse, honoured the Society by visiting the Show on Wednesday, June 26, and was received in the Showyard by the Earl of Yarborough (President of the Society), Sir Gilbert Greenall (Honorary Director), the Stewards, and other Members of Council. His Majesty inspected various exhibits of interest in the Showyard, including the splendid horticultural exhibition arranged by the Local Committee. A statement of receipts and expenditure in connection with the Show will be presented to the General Meeting on December 11. It is estimated that the profit on the Show will be 5,056*l.*, in addition to which there will be the contribution of 2,000*l.* from the ordinary funds of the Society to the Show account.

15. In response to a cordial invitation received from the City of Newcastle-upon-Tyne, the Council have decided that the Show of next year shall be held at Newcastle-upon-Tyne from Tuesday, June 30, to Saturday, July 4. The site, on the Town Moor, where the 1887 meeting was held, is about one mile distant from the Central Railway Station, and is reached by two routes of electric tramways.

16. The Prize Sheet for the Newcastle Show, to be issued early in the New Year, will be of the same comprehensive nature as that provided at Lincoln this year. Towards the Prizes to be offered, 5,000*l.* will be contributed by the Royal Agricultural Society from its own funds, 2,000*l.* by the Newcastle Local Committee, and 300*l.* by the Northumberland and Durham Agricultural Societies. In addition to these amounts, offers of Champion and other Prizes have been received from the following Agricultural and Breed Societies :

Hunters' Improvement Society, Polo and Riding Pony Society, Hackney Horse Society, Shire Horse Society, Clydesdale Horse Society, Shorthorn Society, Dairy Shorthorn (Coates's Herd Book) Association, Lincolnshire Red Short-horn Association, Hereford Herd Book Society, Devon Cattle Breeders' Society, South Devon Herd Book Society, Welsh Black Cattle Society, Polled Cattle Society, English Aberdeen-Angus Cattle Association, Highland Cattle Society, English Jersey Cattle Society, Royal Jersey

Agricultural Society, English Kerry and Dexter Cattle Society, Oxford Down Sheep Breeders' Association, Shropshire Sheep Breeders' Association, Southdown Sheep Society, Hampshire Down Sheep Breeders' Association, Suffolk Sheep Society, Dorset Horn Sheep Breeders' Association, Ryeland Flock Book Society, Kerry Hill Flock Book Society, Lincoln Long-wool Sheep Breeders' Association, Leicester Sheep Breeders' Association, Society of Border Leicester Sheep Breeders, Kent or Romney Marsh Sheep Breeders' Association, Wensleydale Blue-faced Sheep Breeders' Association, Wensleydale Sheep Breeders' Association, South Devon Flock Book Association, Cheviot Sheep Society, Lonk Sheep Breeders' Association, Herdwick Sheep Breeders, National Pig Breeders' Association, British Berkshire Society, Lincolnshire Curly-coated Pig Breeders' Association, and the Poultry Club.

The First Prizes in the most important Classes for Horses will be increased from 15*l.* to 20*l.*, and in the Classes for Cattle, Sheep and Pigs, Third, Fourth and Fifth Prizes will be offered in cases where the Exhibitors exceed a certain number in a Class.

17. The following Prizes, amounting in all to 260*l.*, are offered by the Newcastle Local Committee for the best-managed Farms in Northumberland and Durham :—

CLASS I.—Arable and Grass Farm of 250 and not exceeding 600 acres. First Prize, 60*l.* Second Prize, 30*l.* Third Prize, 15*l.*

CLASS II.—Arable and Grass Farm of 50 acres and not exceeding 250 acres. First Prize, 35*l.* Second Prize, 25*l.* Third Prize, 10*l.*

CLASS III.—Dairy Farm of 50 acres and upwards. First Prize, 50*l.* Second Prize, 25*l.* Third Prize, 10*l.*

The same Farm cannot be entered in more than one Class, but a Competitor in Class I. or Class II. may also enter a Dairy Farm in Class III. if the said Farm is a separate holding.

Entries for the Farm Prizes will close on Tuesday, December 31, 1907. Applications for forms should be addressed to the Secretary of the Society, at 16 Bedford Square, W.C. The entry fee to Members of the Royal Agricultural Society or of the Northumberland or Durham Agricultural Societies will be 1*l.*, and to Non-Members of these Societies, 2*l.*

18. An offer of Prizes of the value of 50*l.* and 25*l.* has been accepted for Plans of Farm Buildings, and the detailed Conditions of Competition are now under consideration.

19. Prizes of Gold and Bronze Medals will be offered in two classes for Manure Distributors for (a) Artificial Manure and (b) Farm-yard Manure.

20. On July 31 a large and influential Deputation attended the Council Meeting to invite the Society to visit the City of Gloucester in the year 1909; and it was unanimously decided to accept the invitation to hold the Show of 1909 in Gloucester, subject to the Society's usual conditions being complied with.

21. For the twelve months ending November 30, 1907, the number of samples analysed in the Society's Laboratory, on behalf of Members, was 459 as against 559 in the preceding

twelve months. In connection with the Lincoln Show 21 samples of Cider and Perry and 133 samples of Milk were also analysed.

22. At the Woburn Experimental Station the Field Experiments continued to show interesting results, and were visited by a considerable number of persons. A trying season ended in a very fair harvest, which was gathered in in good condition. At the Pot Culture Station the Experiments of the year were specially interesting, as bringing out the influence which magnesia has on its relation to lime in the soil, and also in throwing light on the physical conditions of soil as affecting cropping. A collection of specimens from the Pot Culture Station was sent to the Agricultural Education Exhibition at the Lincoln Show, which gave rise to much interesting inquiry.

23. Since the last Annual Report of the Consulting Botanist 182 inquiries have been dealt with from members of the Society. The frosty weather in the spring caused injury to white clover, broad beans, and wheat, and the wet summer and autumn have led to extensive injuries by parasitic fungi. Many investigations have been made into these diseases. Another unobserved enemy to the potato, *Sty lanus capitatus*, has been proved by experiment to attack the living plant. A Hawthorn hedge was seriously affected by *Bostrytis cinerea*. Bacterial injuries to potatoes, broad beans, and oats have been investigated. Scouring in stock was found to be due to the mould developed on the feeding cake.

24. The peculiar weather conditions of the past six months were remarkably reflected in the applications received by the Zoological Department. The ordinary spring pests were rather late in appearing, but nothing of special importance was reported, except the recurrence of the Pygmy Mangold Beetle, which is probably a more frequent and serious pest to mangold than has hitherto been supposed. Then, with the abnormally wet summer, came a large number of complaints of caterpillar attack, and in many instances the caterpillars were of species not usually seriously troublesome. Later again, certain pests generally associated with particularly dry seasons, began to be complained of as the results of the continued fine weeks of the late summer and autumn. The exceptional number of applications for advice have had reference to creatures infesting stored grain and other produce.

25. During the current year there has been no substantial diminution in the prevalence of any of the contagious diseases of animals. In the case of anthrax and sheep-scab the outbreaks to date are slightly in excess of those for last year, and only the outbreaks of glanders show a slight falling off. The

worst features are exhibited by the returns with regard to swine-fever, of which the outbreaks have been nearly three times as numerous this year as last.

26. As the result of this year's examination of students of the Royal Veterinary College in Cattle Pathology, including the diseases of Cattle, Sheep, and Pigs, Mr. H. Tudor Hughes, 26 Willow Street, Oswestry, has been awarded the Society's silver medal, and Mr. M. H. Kingcome, 10 Dunsmure Road, Stamford Hill, N., the bronze medal.

27. The Council, at their last meeting, had before them a suggestion that the Board of Agriculture should be urged to "schedule" Tuberculosis; and, after full consideration, the following recommendation of the Veterinary Committee was unanimously adopted:—"That in the event of the promotion of legislation dealing with the question of Tuberculosis and other diseases of Cattle, the Council of the Royal Agricultural Society of England is of opinion that any regulations for dealing with this question should be issued by the Board of Agriculture and not by any other Department." A discussion ensued as to the desirability of forming a National representative Body to safeguard, as far as possible, the interests of Agriculturists in connection with any measures to be adopted for dealing with the question of Tuberculosis in Cattle; and on the motion of Mr. C. R. W. Adeane, seconded by Mr. Richard Stratton, the Council unanimously resolved:—"That a Committee be formed to communicate with other Societies for the purpose of watching the interests of Agriculture, in view of possible legislation with regard to the Tuberculosis question." The following gentlemen were appointed a Committee to carry out the terms of the resolution:—The Earl of Northbrook, the Hon. Cecil T. Parker, Mr. J. Bowen-Jones, Mr. Richardson Carr, Mr. Ernest Mathews, Mr. C. M. S. Pilkington, Mr. Richard Stratton, and Mr. George Taylor, with power to add to their number. At a subsequent meeting of this Committee, it was decided to invite the various Cattle and County Agricultural Societies to send representatives to attend a meeting to be held at the Royal Agricultural Hall, Islington, at 3 o'clock p.m., on Wednesday, December 11 next.

28. In compliance with a request received from the Board of Agriculture and Fisheries, Mr. J. Marshall Dugdale was appointed to give evidence on behalf of the Society before the Departmental Committee on Agricultural Education. Mr. Dugdale's evidence was taken on May 28 last.

29. The eighth annual examination for the National Diploma in Agriculture was held at Leeds, from May 6-9, 1907, when the following 27 candidates were awarded the Diploma, the first-named candidate gaining Honours:—

*Diploma with Honours.*

**JAMES MACKINTOSH**, Glasgow and West of Scotland Agricultural College, Glasgow.

*Diploma.*

**ROBERT AMENT**, Leeds University.

**THOMAS E. BAYNE-JARDINE**, Glasgow and West of Scotland Agricultural College, Glasgow.

**GEORGE SMITH BEDFORD**, Leeds University.

**JOHN BROWN**, Glasgow and West of Scotland Agricultural College, Glasgow.

**ROBERT BROWN**, Aberdeen and North of Scotland Agricultural College, Aberdeen.

**ALLAN CARRUTH**, Glasgow and West of Scotland Agricultural College, Glasgow.

**ALEXANDER FARQUHARSON CUMMING**, Aberdeen and North of Scotland Agricultural College, Aberdeen.

**DANIEL LINFORD FREEMAN**, Harris Institute, Preston.

**JOHN GETTY**, Royal College of Science, Dublin.

**ALFRED LEONARD GIBSON**, Holmes Chapel Agricultural College, and Harris Institute, Preston.

**JOHN GILLIES**, Glasgow and West of Scotland Agricultural College, Glasgow.

**TEASDALE HILTON HUTCHINSON**, Leeds University.

**ALFRED KILBOE**, Harris Institute, Preston.

**JOHN ESPENETT KNOTT**, Agricultural College, Holmes Chapel, Cheshire.

**ARTHUR SAMUEL LLEWELLYN**, Harris Institute, Preston.

**JOHN WALLACE MCKAY**, Royal College of Science, Dublin.

**ARTHUR DOUGLAS MCKINSTY**, South-Eastern Agricultural College, Wye, Kent.

**GAUPATLAL DAYASHANKER MEHTA**, Cambridge University Agricultural Department.

**WILFRID BERNARD MERCER**, Harper-Adams Agricultural College, Newport, Salop.

**Miss ESTHEE LILWALL ROBINSON**, Harris Institute, Preston.

**CHARLES SAUNDERS**, Harris Institute, Preston.

**DOUGLAS WILLIAM SCOTLAND**, Harper-Adams Agricultural College, Newport, Salop.

**JOHN WILLIAM SHOEBOTHAM**, Harper-Adams Agricultural College, Newport, Salop.

**JOHN HUNTER SMITH**, Glasgow and West of Scotland Agricultural College, Glasgow.

**WILLIAM RICHARD STOKER**, Harris Institute, Preston.

**WILLIAM THOMPSON**, Harris Institute, Preston.

30. The Examinations for the National Diploma in Dairying were held this year for English students at the Midland Agricultural and Dairy College, Kingston, Derby, from September 21-27, and for Scottish students at the Dairy School for Scotland, Kilmarnock, from September 30 to October 4. Twenty-nine candidates were examined at Kingston, of whom 17 passed, and 30 candidates at Kilmarnock, of whom 21 passed. The following are the names of the successful candidates :—

*English Centre.*

**TOM CLARK**, Harper-Adams Agricultural College, Newport, Salop.

**Miss EMMA EVANS**, University College of Wales, Aberystwyth.

**Miss HELEN G. FORMAN**, Midland Agricultural & Dairy College, Kingston, Derby.

MISS IVY G. FULLER, Midland Agricultural & Dairy College, Kingston, Derby.  
 PANDIT RAM GOPAL, British Dairy Institute, Reading.  
 MISS JEAN JONES, University College of Wales, Aberystwyth.  
 WATKIN SAMUEL JONES, University College of Wales, Aberystwyth.  
 PATRICK LEE, Midland Agricultural & Dairy College, Kingston, Derby.  
 A. S. LLEWELLYN, Lancashire C. C. Farm, Hutton, Preston.  
 MISS GRACE HEATHER MASON, British Dairy Institute, Reading.  
 MISS ETHEL MORRIS, British Dairy Institute, Reading.  
 MISS JENNIE SHEMWELL, Midland Agricultural & Dairy College, Kingston, Derby.  
 GEORGE F. SLINGER, Midland Agricultural & Dairy College, Kingston, Derby.  
 WILLIAM THOMPSON, Lancashire C. C. Farm, Hutton, Preston.  
 MRS. TOUSSAINT, Midland Agricultural & Dairy College, Kingston, Derby.  
 STANLEY SCOTT TREVOR, Midland Agricultural & Dairy College, Kingston, Derby, and British Dairy Institute, Reading.  
 MISS MARGARET S. WILD, Midland Agricultural & Dairy College, Kingston, Derby.

*Scottish Centre.*

MISS GWEN BAGNALL, Park Road, Bedford.  
 JAMES MCCULLOCH BROWN, Carleton Terrace, Viccarton Street, Girvan.  
 THOMAS R. D. CARRUTHERS, 7 St. Vincent Street, Edinburgh.  
 ALEXANDER F. CUMMING, Ashgrove, Craigellachie.  
 MISS JEANNIE CURRIE, 3 Woodside Avenue, Gallowflat, Rutherglen.  
 WILLIAM MURRAY DENNY, Cardross Park, Cardross.  
 MISS CONSTANCE MARY EMMERSON, Rylstone House, Biggleswade.  
 JAMES P. GOW, Mountain Hall, Ballantrae.  
 REGINALD GRANT, Kingston House, Llanthwy Road, Newport, Mon.  
 WILLIAM HUNTER, Whiteleys, Stranraer.  
 MISS MARGARETTA A. IRONS, Whitehill, Tannadice.  
 MISS WINIFRED E. LOVE, Sandy, Beds.  
 JOHN GOODWIN LUCAS, 28 Westland Drive, Whiteinch, Glasgow.  
 MISS MARY JANE MCKERROW, Whitehill, New Cumnock.  
 MISS ELSPETH MAY MARTIN, 23 Wilson Street, Hillhead, Glasgow.  
 MISS JEANIE MORRISON, Inghismount, Burghmuir, Perth.  
 ALLISTER OGILVY, Holme Lea, Kelso.  
 WILLIAM PATERSON, Gordonston House, Hamilton Crescent, Partickhill, Glasgow.  
 WILLIAM PATON, Stairvaird, Mauchline.  
 ALEXANDER V. D. RINTOUL, Windmill House, Wye, Kent.  
 MISS ELLA WYLLIE STEVENSON, Parkhill, Mauchline.

By Order of the Council,

THOMAS MCROW,

*Secretary.*

16 BEDFORD SQUARE,  
 LONDON, W.C.

November 7, 1907.



**ANNUAL REPORT FOR 1907 OF  
THE PRINCIPAL OF  
THE ROYAL VETERINARY COLLEGE.**

**RESEARCH LABORATORY.**

**DURING** the year 1907, 873 morbid specimens were forwarded for examination to the Laboratory at the Royal Veterinary College for Research in Comparative Pathology and Bacteriology. The number of similar specimens examined in the three preceding years were:—1906, 855 ; 1905, 692 ; 1904, 654. The Laboratory was founded by the aid of a grant from the Royal Agricultural Society in 1890, and the annual grant of £200, which the Society at present makes to the College, is devoted to defraying part of the cost of the work which is carried on in the Laboratory. As has been mentioned in previous reports, this work is useful in two principal directions : (1) It is helpful to stock-owners and veterinary surgeons by affording assistance in the diagnosis and general investigation of obscure cases of disease ; and (2) the varied collection of morbid material sent for examination is of great value for the instruction of the students.

**ANTHRAX.**

The following Table shows the number of outbreaks of this disease, and the total number of animals attacked in each of the last six years :—

Year	Outbreaks	Animals attacked
1902	678	1,032
1903	767	1,143
1904	1,049	1,589
1905	970	1,317
1906	940	1,326
1907	1,089	1,466

As judged by the number of outbreaks actually reported, anthrax has been more prevalent during the past year than in any of the other years included in the Table, and a reference to the earlier statistics published by the Board of Agriculture and Fisheries shows that the figures for the past year are the highest since 1886, when anthrax was first made a notifiable disease. The fact that in Great Britain somewhere between one and two thousand animals annually die from anthrax invests the disease with a considerable amount of importance, but nevertheless, from an economic point of view, it is much less serious than is generally supposed. The public estimate of its importance is no doubt partly due to the fact that the disease

is communicable to human beings, and that annually a number of persons become affected while dealing with the carcasses of animals that have died from anthrax. The newspaper reports—often more or less sensational—which record such occurrences are apt to convey the idea that the disease is one of a highly contagious character, but that such is not the case is abundantly proved by the published statistics, which show that in the majority of cases what is called an “outbreak” comes to an end with the death of the first animal. Anthrax is no doubt a contagious disease, but it is infinitely less contagious than, say, cattle plague or foot-and-mouth disease, and precautions which would entirely fail to prevent these latter diseases from spreading are quite effectual when applied against anthrax. This difference is due to the fact that, as regards the occurrence of anthrax among the animals of the farm, the chief danger is not in connection with the live diseased animal, but with the carcass. Animals which are affected with anthrax may be the means of spreading the disease while they are still alive, for their urine and fæces may contain the germs of the disease, but experience shows that the danger arising in this way is not great, because the number of “bacilli” which leave the body during life is usually not enormous. On the other hand, the fresh dead carcass is highly charged with danger, because, at least in cattle and sheep, every drop of blood contains myriads of the “bacilli,” and the skinning or cutting of an animal dead of anthrax thus creates a tremendous risk of future trouble. It is to guard against this danger that the Anthrax Order prescribes rigid precautions in dealing with anthrax carcasses, and it is a pregnant fact that the more serious outbreaks, in which a considerable number of animals are attacked, are, on inquiry, nearly always traceable to neglect in dealing with the carcass of the first fatal case.

In previous Reports attention has been drawn to the fact that the majority of the outbreaks of anthrax in this country are not recurrent, but apparently fresh outbreaks on farms previously supposed to be free from the disease, and for this and other reasons the conclusion has been drawn that a large proportion of the outbreaks are caused by anthrax spores in such imported materials as feeding stuffs and manures. The Report of the chief Veterinary Officer to the Board of Agriculture and Fisheries for 1906 contains some figures which are very suggestive in this connection. It is there shown that in five counties, viz., Aberdeen, Somerset, Salop, Wilts, and Cheshire, the total number of outbreaks in the two years, 1905 and 1906, was 474, and that in no fewer than 395 of these the outbreak appeared to be a fresh infection, that is to say, there was no history of a previous case on the same

farm. In the county of Aberdeen alone there were 224 outbreaks in these two years, but only on six farms did more than one outbreak occur in twelve months. Experience is therefore accumulating to show (1) that when an animal dies from anthrax and its carcass is promptly disposed of in accordance with the law, there is little likelihood that there will be any further trouble traceable to this outbreak ; and (2) that many of the outbreaks in this country are of the nature of independent fresh infections from foreign food materials containing anthrax germs. This latter danger must be recognised, but at the present time it does not appear to be possible to deal with it by legislation. There is some reason to think that feeding cake from one particular country is specially dangerous in this connection, but anthrax is very prevalent in nearly all the countries from which linseed or cotton-seed and the cakes manufactured from them are imported, and it is easy to understand how feeding stuffs from any of them may be infected.

## GLANDERS.

The following Table shows the number of cases of this disease for each of the past six years :—

Year	No. of cases	Year	No. of cases
1902	2,040	1905	2,068
1903	2,499	1906	2,012
1904	2,628	1907	1,934

In former Reports it has frequently been pointed out that the Order under which glanders has been dealt with since 1894 could never be expected to stamp out the disease, because it ignored the fact (1) that glanders is spread and perpetuated by "in-contact" horses which are infected although presenting no outward or clinical symptoms, and (2) that the discovery of mallein had placed in the hands of local authorities an easy method of detecting such latent cases of disease. It is matter for congratulation that a new Order remedying these defects is to come into force on the 1st January, 1908. This Order will greatly strengthen the hands of local authorities, inasmuch as it gives power to place restrictions on the movement of horses known to have been exposed to contagion, and ordains the slaughter of horses which have reacted to mallein, the owner to receive half value in compensation when the diagnosis is confirmed by post-mortem examination, and full value when it is not confirmed. It can scarcely be doubted that if full advantage is taken of these new powers a marked impression will within

a few years be made on the prevalence of glanders, and it is even permissible to hope that by their means the disease will eventually share the fate of rabies, pleuro-pneumonia, and foot-and-mouth disease, and be entirely eradicated from this country.

#### SWINE FEVER.

The following Table shows the number of outbreaks of this disease for the past six years :—

Year	Outbreaks	Year	Outbreaks
1902	1,688	1905	817
1903	1,478	1906	1,280
1904	1,196	1907	2,336

These figures speak for themselves. They show that during the past year swine fever has been nearly three times as prevalent as it was in 1905, and as a matter of fact we appear to be no nearer the extermination of the disease than we were ten years ago (1897, when there were 2,155 outbreaks). During the five years 1901-1905 the operations of the Board of Agriculture and Fisheries reduced the annual outbreaks from 3,140 to 817, and it appeared probable that the measures which had been so far effectual would, if persevered with, actually succeed in stamping out the disease. It must be confessed that any such prospect now appears remote. That there are great difficulties in the way of exterminating swine fever is obvious to any one acquainted with the characters of the disease, but all these difficulties were in existence in the period 1901-1905, when the number of outbreaks was being steadily reduced. It may be taken as certain that no alteration in the character of the disease has recently taken place, and the cause of the recrudescence of the disease during the last two years must be sought for either in some change in the regulations prescribed by the Board or in the attitude of the owners of swine. In previous Reports it has been suggested that the earlier success of the Board was due to the regulations having been at that time drafted on what may be called cattle-plague lines, and that, provided the object in view was to stamp out the disease, it was a mistake to lessen the stringency of the measures when in force. In particular, it appeared to be unwise just at the time when the Board seemed to be getting the upper hand of the disease, to modify the slaughtering-out method, and to rely on isolation of suspected pigs for bringing outbreaks to an end or preventing the spread of the disease. The past year's experience only tends to confirm these views.

Regarding the question whether the increased prevalence of the disease during the last two years is partly due to a changed attitude on the part of pig owners, it may be observed that unless the regulations are of such a kind as to commend themselves to the majority of owners, stamping-out is impossible. The voluntary co-operation of the owner is essential, because concealment of swine fever is comparatively easy, and the danger of discovery when the law is contravened is not great. It is therefore easy to understand that less liberal terms in dealing with owners, and especially the practice of refusing to slaughter out and compensate, may have led to more frequent concealment of disease, and thus have powerfully contributed to the recent spread of swine fever. To counteract this, concealment ought to be made unprofitable by imposing a serious penalty when it is discovered.

#### JOHNE'S DISEASE.

In the previous Annual Report, attention was called to the existence of this disease in Great Britain, and the experience of the past year shows that it is, unfortunately, comparatively common. Apparently, it has hitherto been generally confounded with tuberculosis and parasitic gastritis, but as it is easy to diagnose post-mortem, there will be no excuse for such mistakes in the future. There can be little doubt that the great majority of cases of chronic fatal diarrhoea in cattle are of this nature. During the past year a case of apparent recovery was observed, but in all the other instances that have come under notice the course of the disease was from bad to worse. The exceptional case was a yearling which, along with a cow on the same farm, developed symptoms of the disease in the autumn of 1906. Both animals were brought to the College, and soon afterwards the cow was killed and the disease verified at the post-mortem examination. The yearling, although not medicinally treated, gradually ceased to scour, and gained a little in condition. It was killed six months after admission, and the post-mortem examination showed that the intestine was normal in appearance, while none of the characteristic bacilli could be detected with the microscope.

The fact remains, however, that when the disease has advanced so far as to cause decided symptoms (the chief of which are diarrhoea and wasting) the case may be considered hopeless, and the wisest course is to have the animal destroyed as a source of danger to others.

The most important new fact regarding the disease which has come to light during the past year is that it is not, as had previously been supposed, absolutely peculiar to cattle. During the year recourse was had to the Laboratory for

assistance in ascertaining the cause of chronic diarrhoea among deer kept in a park, and when one of the diseased animals was killed the post-mortem examination unexpectedly disclosed the fact that it was the subject of Johne's disease.

The fact that deer may suffer from the disease is not one of much direct interest, but it is of importance as suggesting that other ruminants, such as the sheep, may not be immune. It is intended to carry out experiments to test this possibility.

#### REDWATER IN CATTLE.

In a previous Annual Report (Vol. 66, page 143), an account was given of the pathology of this disease, including some hints regarding measures of prevention. The disease is again referred to here because it has been found that the old erroneous opinions regarding its cause are still widely held.

It must therefore be repeated that redwater is caused by a microscopic blood parasite which is transferred from affected to healthy cattle by means of ticks. It is the fact that ticks play an essential rôle in the causation of the disease that explains the peculiar regional and seasonal occurrence of cases of redwater.

Cattle of any age can be infected with redwater, but, whereas the disease is generally severe and frequently fatal in adults or animals over two years of age, it is of so mild a character in calves or animals under a year old that it generally fails to excite in them any visible disturbance of health. As one attack of the disease tends to render an animal insusceptible, cattle which are infected during early life rarely afterwards become visibly affected or die, even although they are grazed on notoriously dangerous ground. Nevertheless these animals are not entirely free from the disease, for the rule is that when once an animal has been infected it ever afterwards, or at any rate for years, continues to harbour the minute parasites which are the cause of redwater. This may in most cases be readily proved by using a small quantity of their blood for the inoculation of a healthy adult ox, the almost invariable result being that the inoculated animal develops the symptoms of redwater after about a week. On what may be called redwater pasture the animals which were infected while young tend to perpetuate the disease, for ticks in sucking their blood become infective and pass the parasites on to other animals on the same pasture.

These facts give the clue to the prevention of the disease. If ticks could be eradicated from any given pasture, redwater would thereby be stamped out, but in actual circumstances such eradication is usually difficult. It may, however, be achieved by keeping cattle and other animals off the pasture for

one whole year, as this probably exceeds the greatest possible lifetime of a tick which is denied the opportunity to suck the blood of an animal. Fortunately, however, there is a simpler and less expensive method of, so to speak, cleansing a pasture, and that is to graze it exclusively with horses or sheep for a full period of one year. Such a procedure does not lead to the extermination of the ticks, for these may maintain their existence and propagate their species on horses and sheep, but as only cattle can be infected with redwater, an infective tick ceases to be dangerous after it has attached itself to a sheep or a horse. It is to be hoped that in this country attempts will soon be systematically made to stamp out redwater by taking advantage of the facts just mentioned. It must be noted, however, that an essential part of this plan is that after the full year has been allowed for the cleansing of the ticks, no animal of the ox species that has had an attack of redwater or which has even been grazed on redwater ground must be allowed on the purified pasture, because, as already explained, such animals often for life contain the germs of the disease in their blood, and would therefore provide the means for re-infecting the ticks.

Although the measures here advised can scarcely anywhere be altogether impracticable, it is obvious enough that in general a certain amount of loss and inconvenience would be caused in carrying them out, and it may therefore be asked whether there is any other means by which a farmer may prevent or reduce the loss which he annually suffers from redwater. That there is another method in reality follows from what has already been said, for it has previously been explained that the disease, when contracted in youth, is usually so mild as to be of little consequence to the animal and yet protects it for the rest of its life. Hence, where the more radical measures sketched above cannot be put into operation, a farmer may seek to minimise his losses by grazing the dangerous land exclusively with young cattle, or with cattle which have been for at least one season on such land. This plan is, however, not free from risk, for although an animal may have been grazed as a calf on dangerous tick-infested ground, it may have accidentally escaped infection and thus failed to acquire immunity. The probable consequence would be that when this same animal returned to the pasture next season it would contract the disease in a dangerous form. To counteract this risk the owner might assure the infection of his calves, or of such of them as were afterwards to be grazed on the dangerous pasture, by having them inoculated with the blood of an animal known to have recently recovered from an attack of redwater, as experience shows that this is an operation attended with little or no risk in the case of animals under six months old.

In conclusion it ought to be pointed out, however, that all animals which have thus been vaccinated against redwater, and all those which have been grazed on infected pasture, are capable of carrying the seeds of the disease to pasture previously healthy, provided they carry ticks with them or ticks are already there. This danger scarcely exists in moving infected animals to land subject to rotation of crops, for ticks cannot there permanently establish themselves, but the risk is a very real one when infected cattle are moved to permanent pasture or moorland.

#### THE TRANSMISSIBILITY OF BOVINE TUBERCULOSIS TO MAN.

It will be remembered that in the course of an address delivered at the Congress for the study of Tuberculosis in London, in July, 1901, Professor Koch renounced the opinion which he had formerly expressed regarding the identity of human and bovine tuberculosis, and openly declared that the question whether man could be infected from cattle was unproved, but that if such transmission ever took place the occurrence was so rare that it was not advisable to take any measures against it.

The controversy which was then started has been since maintained, but fortunately it appears to be drawing to a close, at least with regard to the main point of dispute. As a result of Koch's pronouncement a Royal Commission was appointed in this country in the autumn of 1901 to investigate the relationship between human and animal tuberculosis, and it has since been continuously engaged with this problem. Simultaneously experiments bearing on the same question have been carried on in Germany, and during the course of the present year both the English<sup>1</sup> and the German<sup>2</sup> Commissions have published exhaustive reports giving the result of their researches to date.

The general plan of the experiments carried out in the two countries was substantially the same, and, as might have been expected where competent workers were engaged, the results are also in close agreement. The English Royal Commission made a painstaking investigation of sixty cases of tuberculosis occurring in human beings, and came to the conclusion that in fourteen of these the bacilli which caused the disease had been derived from cattle. The German Commission similarly investigated sixty-seven cases of the disease in man, and in eleven of these they found bacilli which were identified by them as bovine bacilli. In two of these eleven cases the patient had been infected both from a human and a bovine

<sup>1</sup> Royal Commission on Tuberculosis. Second Interim Report.

<sup>2</sup> Tuberkulose-Arbeiten aus dem Kaiserlichen Gesundheitsamte. 6 Heft.



source, but in the other nine the lesions contained bovine bacilli only.

All these nine German cases occurred in children, and in eight of them the primary seat of disease was in connection with the glands attached to the intestine or those in the neck. The total number of cases investigated in children under twelve years of age in which infection appeared to have taken place through the intestine was twelve, and in six of these the only bacilli present were bovine bacilli.

In the English cases twenty-eight appeared to have been infected by way of the alimentary canal, and in thirteen of these the bacilli were of the bovine type.

As previously remarked, it was to be expected that, since they followed the same methods of investigation, the English and German Commissions would obtain substantially the same experimental results; but there was, of course, no such certainty that they would draw the same conclusions from these results. As a matter of fact, however, the conclusions are very similar.

What are called the practical results of the German investigations, so far as these relate to the infection of human beings from cattle, are stated as follows:—

“1. The fact that tubercle bacilli of the bovine type have been detected in tuberculous lesions of human beings shows that the human body is capable of becoming infected with the discharges (milk for example) or the tuberculous flesh of the domesticated animals, when such materials contain tubercle bacilli.”

“2. The alterations in the tissue of human beings which are caused by tubercle bacilli of the bovine type are in a notable number of cases limited to the place at which the germs entered and the neighbouring lymphatic glands, or to the latter alone. Nevertheless tubercle bacilli of the bovine type have also been found in cases of tuberculosis in which the disease had spread to remote parts of the body, and had actually caused the death of the patient.”

“3. Accordingly, the use by human beings, and especially by children, of articles of diet derived from tuberculous animals and containing tubercle bacilli of the bovine type cannot be regarded without misgiving.

“4. A scientific system of meat inspection affords a valuable protection against the transference of tubercle bacilli to human beings by means of meat, and an added protection is afforded by the appropriate preparation of the meat (thorough boiling or roasting).”

“5. The possibility of the transference of tubercle bacilli with milk or milk products to human beings will be notably diminished by actively combating tuberculosis among cattle. Tubercle bacilli contained in milk can be killed by proper heating of the milk.”

The conclusions arrived at by the English Royal Commission are as follows:—

“There can be no doubt but that in a certain number of cases the tuberculosis occurring in the human subject, especially in children, is the direct result of the introduction into the human body of the bacillus of bovine tuberculosis; and there also can be no doubt that in the majority at least of these cases the bacillus is introduced through cows' milk. Cows' milk

## 210 *Annual Report for 1907 of the Consulting Chemist.*

containing bovine tubercle bacilli is clearly a cause of tuberculosis, and of fatal tuberculosis, in man."

\* \* \* \* \*

"These facts indicate that a very large proportion of tuberculosis contracted by ingestion is due to tubercle bacilli of bovine source.

"A very considerable amount of disease and loss of life, especially among the young, must be attributed to the consumption of cows' milk containing tubercle bacilli. The presence of tubercle bacilli in cows' milk can be detected, though with some difficulty, if the proper means be adopted, and such milk ought never to be used as food. There is far less difficulty in recognising clinically that a cow is distinctly suffering from tuberculosis, in which case she may be yielding tuberculous milk. The milk coming from such a cow ought not to form part of human food, and indeed ought not to be used as food at all.

"Our results clearly point to the necessity of measures more stringent than those at present enforced being taken to prevent the sale or the consumption of such milk."

J. MCFADYNEAN.

Royal Veterinary College,  
London, N.W.

---

## ANNUAL REPORT FOR 1907 OF THE CONSULTING CHEMIST.

THE year 1907 has shown a somewhat marked diminution in the number of samples submitted by members of the Society for analysis in the Society's Laboratory. During the twelve months ending November 30, 1907, the total number sent has been 462, as against 559 in 1906, and 571 in 1905. To what extent this diminution is to be attributed to the operation of the Fertilisers and Feeding Stuffs Act it is hard to say, but there can be little doubt that the introduction of the new Act of 1906 has brought about a feeling of confidence so far as purchasers are concerned. And though the Act itself is no more made use of than it was, and while, indeed, a check has been placed by it on the activity of County Councils, there is no question that the purchaser in general thinks there is less need now than formerly of having the materials he buys submitted to analysis. This has been brought about mainly through the obligation imposed, under the new Act, on the vendor, to guarantee not only approximately, but within stated limits, the quality of what he supplies. So far, however, as actual prosecution in cases of deficiency or adulteration goes, the Act has, like its predecessor, been practically a "dead letter." As I have pointed out before, the obligation to take an official sample within ten days of delivery of purchase or receipt, has proved, as I expected it would, a bar to subsequent proceedings even when the circumstances justified such. Also the added necessity of obtaining the sanction of the Board of

Agriculture to the instituting of a prosecution has damped the ardour of many County Councils who before had shown a praiseworthy activity. Farmers are quite willing to have "informal" samples taken of their purchases, so long as this involves no responsibility nor trouble to themselves, and especially if, by so doing, they can get analyses made for nothing, or for a merely nominal sum, but it is only when they suspect themselves to have been "done" that they will trouble further, and then in 99 cases out of 100 they find that the statutory limit of ten days has already been exceeded. I have been blamed, I may say, for prognosticating that the new Act would be made little more use of, if as much, as its predecessor, but I already find full confirmation of my views as originally expressed. As regards the traders, it must be said to their credit, that they have, as a class, loyally complied with the requirements of the Act, and the farmer has had the full benefit of the provisions introduced by it. In some cases, to which reference will be made, it has been sought, by the insertion of qualifying clauses, to evade the spirit of the Act, and in others guarantees have been given in terms not contemplated by the Act, and with "margins," as regards composition, much in excess of the limits imposed under it.

Meanwhile, the work conducted for members of the Society goes on, if to a somewhat smaller extent, yet without loss of activity nor without providing useful guidance to those who avail themselves of the privileges afforded them.

The past season has not brought to light any new points of particular importance; there has not been the introduction of any new materials either for food or manure, nor has any novel form of adulteration been brought to light. The satisfactory features are the general excellence of linseed cakes and their freedom from impurity, while the increasing demand—a mistaken one in many cases, I consider—for compound cakes and meals has led to a corresponding laxity in regard to the materials of which they are composed. The inability of the Fertilisers and Feeding Stuffs Act to deal adequately with these has been specially marked, and it has been made more and more apparent that a mere guarantee of oil and nitrogen, independently of a consideration of the sources from which these are derived, is useless as a guide to the real feeding value of such compound materials. Encouragement has thereby been given to the setting out of guaranteed analyses showing high percentages of oil and nitrogen, and to judging these as if they had been obtained from a high-class feeding material such as linseed cake.

The detailed list of samples analysed is given at the end of this report, and it may be mentioned that, in addition to these, 21 samples of cider and perry and 133 samples of milk were

analysed in connection with the prizes awarded at the Society's Show held at Lincoln in June, 1907.

A. FEEDING STUFFS.

1. *Linseed Cake.*

These, as noted, have been almost uniformly of good character. It has, indeed, but seldom happened, in the case, at least, of samples submitted to me, that cakes invoiced as "Linseed cake" have been found to be impure, and, speaking generally, no practical difficulty has been experienced in complying with the demands of the Fertilisers and Feeding Stuffs Act as regards the "limits" beyond which the composition shall not vary.

In one instance brought to my notice the purchaser had ordered "Linseed cake" and, on the invoice reaching him, it was noticed to describe the cake as "Linseed cake" but to have also the following qualifying note :—

"To comply with the Fertilisers and Feeding Stuffs Act, 1892, notice is hereby given that the Article or Articles invoiced above have been prepared from more than one substance or seed, and may be mixed or compounded with substances or seeds other than those implied by the name. The articles, however, are warranted to be of known quality or similar to sample shewn.

"Not responsible for weight, measure or quality after the delivery of the goods, or for the age, growth or sort of any seed."

The effect of such a note is to vitiate the guarantee conveyed in the use of the description "Linseed cake," for linseed cake must be made from one substance or seed only, viz., Linseed, and may not be compounded with other substances or seeds. Purchasers receiving invoices thus marked should return them, or the delivery, and insist upon having their goods properly described.

2. *Cotton Cake.*

The ordinary undecorticated cotton cake—made from Egyptian seed, as it is generally described—has been, as a rule, of good quality, and but few cases have occurred in which the seed has not been well cleaned or excess of sand been found. The use of borax as a preservative would appear also to have largely diminished. The unrestricted employment of a medicinal material of this kind is decidedly objectionable.

Bombay cotton cakes, with the inducement of their lower price, have continued to be extensively used. But I am no more favourable than before to their employment, and seeing that neither cotton wool nor woody fibre can be called "feeding materials," any more than peat, I consider them, as a whole, to compare unfavourably with good Egyptian seed cake at the higher price asked for it. Of course Bombay cotton cakes

vary much ; some are much better than others, and some are little more than husk and wool, but the purchaser takes his chance of this ! Nor can I say that the quality of Bombay cotton cakes has, in general, improved, but rather the reverse. Samples I have had continue to show excessive sand and dirt, and many have very excessive amounts of wool. Instances are the following :—

	A	B	C
Moisture . . . . .	13·30	11·64	11·73
Oil . . . . .	4·13	4·43	6·29
<sup>1</sup> Albuminous compounds(flesh-forming matters) . . . . .	20·13	19·31	17·62
Mucilage, sugar, and digestible fibre . . . . .	21·31	37·51	34·22
Woody fibre (cellulose) . . . . .	35·56	20·99	26·20
<sup>2</sup> Mineral matter (ash) . . . . .	5·57	6·12	3·94
	100·00	100·00	100·00
<sup>1</sup> Containing nitrogen . . . . .	3·22	3·09	2·82
<sup>2</sup> Including sand . . . . .	2·19	1·20	0·10

“A” cost 4*l.* 12*s.* 6*d.* per ton. It was a very hard cake and contained much wool ; the percentage of woody fibre (35·56), as shown in the analysis, is exceptionally high, and the sand (2·19) also very excessive. “B” cost 4*l.* 10*s.* per ton, and was also very woolly. “C” was described as “Kibbled Cotton cake.” It cost 4*l.* 18*s.* 9*d.* per ton, delivered, and though in some respects—notably the oil—the analysis reads well, the cake is very poor in nitrogen, and, on sifting it after breaking it up, no less than 75 per cent. of it was found to consist of husk and wool.

Decorticated cotton cake has, as usual, been almost impossible to get of nice soft quality, and in many instances it has not been as well decorticated as it should be. The home-made variety has been used to some extent, but that, too, has not been of really high class.

#### *Pieces of Metal in Bombay Cotton Cake.*

In a consignment of three tons of Bombay cotton cake sent to a member of the Society there were noticed to be pieces of metal, some of considerable size. The purchaser had the whole delivery carefully broken up and from the three tons he extracted no less than 342 pieces of metal, these consisting of a miscellaneous collection of flattened nails, iron bolts and nuts, strips of steel (as if they had come from broken machinery), hair pins, and the like. It is needless to say that had the presence of this in the cake not been noticed serious loss of stock would inevitably have occurred. This would have been an interesting case under the Fertilisers and Feeding Stuffs Act,

and, anyhow, it is well to put purchasers on their guard in respect of the possible presence of extraneous materials of this kind.

### 3. *Compound Cakes and Meals.*

"A" spiced cake. "B" compound cake. Two deliveries of cake, sold under the foregoing respective names, were made to a purchaser in Kent, and samples sent for analysis gave the following results:—

	A Spiced cake.	B Compound cake.
Moisture . . . . .	11·22	12·79
Oil . . . . .	9·79	11·03
<sup>1</sup> Albuminous compounds (flesh-forming matters) . . . . .	18·69	19·63
Starch, sugar, and digestible fibre. . . . .	40·60	40·65
Woody fibre (cellulose) . . . . .	11·82	8·86
<sup>2</sup> Mineral matter (ash) . . . . .	7·88	7·04
	<hr/> 100·00	<hr/> 100·00
<sup>1</sup> Containing nitrogen . . . . .	2·99	3·14
<sup>2</sup> Including sand and silica . . . . .	2·84	1·35

"A," it will be noticed, contained an excessive amount of silica, this was largely due to the presence of a quantity of rice husk, a worthless and objectionable ingredient; further, the cake contained a good deal of weed seeds, prominent among which were polygonum and corn cockle. "B" cost 7*l.* 5*s.* per ton, delivered, and consisted to a large extent of materials of unsatisfactory nature, rice husk, rape seed, and weed seeds being present in considerable quantity.

### 4. *Molasses Feeding Materials.*

In addition to "molassine meal" and "molascuit" there are many other combinations in which molasses, either of beet sugar or cane sugar origin, figures, and which have been noted from time to time. Of fresh materials brought to my notice are the following, the analyses of which are appended:—

	A Cattle Food.	B Derby Sugar Food.
Moisture . . . . .	20·01	19·12
Oil . . . . .	3·16	1·13
<sup>1</sup> Albuminous compounds (flesh-forming matters) . . . . .	11·82	10·94
Starch, sugar, and digestible fibre. . . . .	47·37	56·00
Woody fibre (cellulose) . . . . .	11·35	4·89
Mineral matter (ash) . . . . .	6·29	7·92
	<hr/> 100·00	<hr/> 100·00
<sup>1</sup> Containing nitrogen . . . . .	1·89	1·75

"A" was, practically, nothing but molasses and earthen cake meal. "B" was simply a mixture of molasses and bran.

#### 5. Meat Meal—for pigs.

Analyses of samples of two deliveries of meat meal, used as food for pigs, gave the following results :—

	A	B
Moisture . . . . .	9.94	8.88
Fat . . . . .	21.55	9.62
<sup>1</sup> Organic matter . . . . .	64.76	80.45
Mineral matters (ash) . . . . .	3.75	1.05
	100.00	100.00
<sup>1</sup> Containing nitrogen . . . . .	10.46	13.03

"A" cost 18s. per cwt., delivered, and "B" 13s. 6d. per cwt. While, if mixed with other foods, these might be usefully employed for pig-feeding, their highly nitrogenous character would oblige their being used with caution. Further, the prices of them, more especially of "A," are much too high.

### B. FERTILISERS.

The supply of mineral superphosphate of lime, as of the commoner manufactured fertilisers, has been of quite a satisfactory character, and I have had nothing to report adverse to these. It is however, in the matter of compound manures, often made from waste materials, that there is scope, despite the Fertilisers and Feeding Stuffs Act, for selling these materials at prices far beyond their real value. The Act does not touch these, for they are sold as required, by guaranteed analysis, but there is no security that the cost is commensurate with the value. In regard to Basic Slag it has also to be mentioned that, notwithstanding the Act and its requirement that the exact percentage of phosphate contained shall be guaranteed, it is not unusual still to see invoices set out in some such form as the following :—" guaranteed to contain 38—45 per cent. of phosphates." Such a form of guarantee is quite contrary to the Act, for it allows of a margin of 7 per cent. whereas the Act allows only 2 per cent. Purchasers receiving invoices set out thus should return them and insist on having them set out in accordance with the Act.

#### 1. Bone Meal.

A purchase made under the name of "Continental Bone Meal" was found, on analysis, to have the following composition :—

Moisture . . . . .	5·78
<sup>1</sup> Organic matter . . . . .	37·75
Phosphate of lime . . . . .	40·06
Carbonate of lime, &c. . . . .	5·78
Sand. . . . .	10·63
	100·00
<sup>1</sup> Containing nitrogen . . . . .	4·96
Equal to ammonia . . . . .	6·02

This sample, it will be noticed, contained over 10½ per cent. of sand and grit. The high percentage of Ammonia is accounted for by the presence of meat refuse.

2. *Superphosphates.*

An instance of an excellent delivery, sold at a very low price, is the following:—

Moisture . . . . .	15·18
Organic matter and water of combination . . . . .	9·42
Monobasic phosphate of lime . . . . .	20·97
Equal to tribasic phosphate of lime (bone phosphate) rendered soluble by acid . . . . .	(32·83)
Insoluble phosphates. . . . .	1·19
Sulphate of lime, alkaline salts, &c. . . . .	48·50
Insoluble siliceous matter . . . . .	4·74
	100·00

This cost only 47s. 6d., per ton delivered, which makes the unit price of soluble phosphate per ton 1s. 6d. only.

3. *Compound Manures.*

Below are given the analyses of two samples, the one called "Eclipse Compound Fish Manure," the other "Raw Blood and Bone Compound," which were sold at prices much above their real value.

	A	B
	Eclipse Compound Fish Manure.	Raw Blood and Bone Compound.
Moisture . . . . .	15·30	13·44
<sup>1</sup> Organic matter and water of combination . . . . .	23·48	27·73
Monobasic phosphate of lime . . . . .	3·58	5·80
Equal to tribasic phosphate of lime (bone phosphate) rendered soluble by acid. . . . .	(5·59)	(9·08)
Insoluble phosphates . . . . .	2·99	4·56
Sulphate of lime, alkaline salts, &c. . . . .	14·92	24·05
Insoluble siliceous matter . . . . .	39·73	24·42
	100·00	100·00
<sup>1</sup> Containing nitrogen . . . . .	1·13	1·17
Equal to ammonia . . . . .	1·37	1·42



“A” was sold under a guarantee of containing 2 to 3 per cent. of ammonia, and 6 to 8 per cent. of soluble phosphates—a guarantee which, by the way, is not in accordance with the Act. The cost of the manure was 3*l.* per ton—a favourite price, as I have pointed out before, for materials of this class. In regard to actual deficiency, an allowance of 8*s.* 6*d.* per ton was claimed and allowed, but a price of 2*l.* per ton would have fully represented the actual value of the manure.

“B” cost 5*l.* 5*s.* per ton, which was just about double its value.

Another material sold as “Fertiliser,” and which was very dear, is the following :—

Moisture . . . . .	24·97
<sup>1</sup> Organic matter . . . . .	36·16
Phosphate of lime . . . . .	3·68
Oxide of iron and alumina, &c. . . . .	16·19
Sand . . . . .	19·00
	<hr/>
	100·00
	<hr/>
<sup>1</sup> Containing nitrogen . . . . .	2·69
Equal to ammonia . . . . .	3·27

The price of this was 70*s.* per ton, delivered. I should have considered it dear even at 50*s.*

#### 4. Rape Dust.

Rape dust, sold for manurial purposes, is unfortunately often liable to contain excessive amounts of sand and earthy matter. The following is an example, the sample containing 13½ per cent. of sand :—

Moisture . . . . .	11·58
<sup>1</sup> Organic matter . . . . .	67·36
<sup>2</sup> Phosphoric acid. . . . .	1·96
Lime, magnesia, &c. . . . .	5·37
Sand . . . . .	13·73
	<hr/>
	100·00
	<hr/>
<sup>1</sup> Containing nitrogen . . . . .	4·54
Equal to ammonia . . . . .	5·51
<sup>2</sup> Equal to phosphate of lime . . . . .	4·28

#### 5. Soot.

Soot is a material of variable nature, but the samples that have passed through my hands this year have been of quite good quality. I give here the analyses of three such samples :—

Percentage of :—	A	B	C
Nitrogen . . . . .	4·38	4·97	4·13
Equal to ammonia . . . . .	5·32	6·04	5·02
Mineral matter . . . . .	25·85	24·29	21·81
containing Sand . . . . .	14·60	8·78	13·15

6. *Native Guano.*

This material, prepared from sewage, has been found to vary considerably in regard to the amount of moisture which it contains. If properly dried and sent out carefully, it will contain only about 17 per cent. of moisture, but I have examined a number of samples and found the degree of dampness to vary. When the material is not properly dried not only is its value to the purchaser materially affected, but the mass is very subject to ferment and to heat considerably. The following comparative analyses of two samples submitted to me will illustrate this difference :—

	A	B
Moisture . . . . .	17·67	30·71
<sup>1</sup> Organic matter . . . . .	47·39	38·33
Lime . . . . .	3·13	2·65
<sup>2</sup> Phosphoric acid . . . . .	1·67	0·91
Oxide of iron, alkalis, carbonic acid, &c.	11·24	8·60
Sand . . . . .	18·90	18·80
	<hr/> 100·00	<hr/> 100·00
<sup>1</sup> Containing nitrogen . . . . .	1·97	1·74
Equal to ammonia . . . . .	2·39	2·11
<sup>2</sup> Equal to phosphate of lime . . . . .	3·65	1·99

These analyses show a difference of 13 per cent. of moisture in the two samples, while the phosphates are much reduced in sample "B."

7. *Lime Screenings.*

One is rightly suspicious, as a rule, about purchasing waste lime, lime screenings, and the like, especially when no guarantee is given. It happens occasionally, however, that such can be obtained cheaply, as illustrated in the following analysis :—

Lime (caustic) . . . . .	per cent. 52·39
Siliceous matter . . . . .	12·75

The cost of this was only 3s. 4d. per ton delivered, and it must be considered well worth getting.

C. MISCELLANEOUS MATERIALS.

*Lead in Cider.*

A member of the Society sent me for examination a sample of Cider drawn from a cask, saying that several of his men complained of illness after drinking the Cider. On testing the

sample I found it to be impregnated to a considerable extent with lead. It was found that a patch had been made with lead when repairing the cask, and no doubt in this way the lead came in and caused the harm complained of.

*!Lead in White-washing paint.*

A case involving a somewhat unaccountable loss of calves was investigated by me, for a member of the Society. He had to complain of the death of a number of his calves. The different foods given to them were analysed and found to be perfectly good. Attention was then turned to the fact that the walls of the stalls in which the calves were had been white-washed with a preparation sold as taking the place of lime-washing. The walls were noticed to be scaling, and the calves licked the loose pieces off. An examination of some of these pieces revealed the presence of a decided amount of lead, and subsequent examination of the stomachs of some of the calves that died also showed lead in quantity. The vendors of the paint maintained that they did not use lead in their preparation, and a sample they submitted direct certainly contained none, but was composed chiefly of carbonate of lime with zinc and some barytes. The vendors, however, were not themselves the makers, and, anyhow, it was made clear that the deliveries made to the owner of the calves did contain lead paint, and the calves, attracted no doubt by the linseed oil in the preparation, licked it off, and so took the lead into their systems, with the disastrous consequences related.

List of samples analysed on behalf of members of the Society between Dec. 1, 1906, and Nov. 30, 1907:—

Linseed cakes . . . . .	53
Undecorticated cotton cakes . . . . .	29
Decorticated cotton cakes . . . . .	6
Compound feeding cakes and meals . . . . .	41
Cereals . . . . .	12
Rice meal . . . . .	2
Dried grains . . . . .	2
Superphosphates . . . . .	26
Dissolved bones and compound manures . . . . .	26
Raw and steamed bones . . . . .	15
Peruvian guano . . . . .	8
Fish, meat, and bone guano . . . . .	8
Sewage sludge, &c. . . . .	6
Basic slag . . . . .	28
Nitrate of soda . . . . .	4
Sulphate of ammonia . . . . .	7
Potash salts . . . . .	14
Shoddy . . . . .	26
Hoofs and horns . . . . .	3

220 *Annual Report for 1907 of the Consulting Botanist.*

Chalk . . . . .	1
Lime . . . . .	11
Soot . . . . .	7
Waters . . . . .	68
Soils . . . . .	17
Milk, cream, and butter . . . . .	12
Miscellaneous . . . . .	30
	Total . . . . . 462

J. AUGUSTUS VOELCKER.

22 Tudor Street,  
London, E.C.

## ANNUAL REPORT FOR 1907 OF THE CONSULTING BOTANIST.

DURING the past year 184 inquiries from members of the Society have been dealt with. These referred to the quality of seeds, the names and treatment of weeds, the diseases of cultivated plants, and more miscellaneous subjects.

### PURITY AND GERMINATION OF SEEDS.

The seed harvest of 1906 was very satisfactory, both at home and abroad, consequently the samples examined were of good quality, and on the whole the germination was higher than usual. Only two of the samples may be referred to; one of imported Italian rye-grass which contained eleven per cent. of worthless seeds. The mixture consisted of:—

Italian rye-grass ( <i>Lolium italicum</i> Linn.) . . . . .	89.0
Brome grass ( <i>Bromus mollis</i> Linn.) . . . . .	2.2
Yorkshire fog ( <i>Holcus lanatus</i> Linn.) . . . . .	1.7
Buttercup ( <i>Ranunculus arvensis</i> Linn.) . . . . .	1.5
Trefoil ( <i>Medicago lupulina</i> Linn.) . . . . .	2.3
Field Madder ( <i>Sherardia arvensis</i> Linn.) . . . . .	1.2
Rib grass ( <i>Plantago lanceolata</i> Linn.) . . . . .	1.1
Forget-me-not ( <i>Myosotis arvensis</i> ) . . . . .	1.0
	Total . . . . . 100

It should be impossible for any honest and intelligent seed merchant to offer these seeds to a farmer. It is time that those in the trade who are ignorant of the goods they deal in, and whose only object is to make a profit, should be held responsible for the injury they bring to the farmer by causing him to sow one or more worthless or baneful weeds with every

eight or nine seeds of the kind he believes he has purchased. But only less to be blamed is the farmer who puts on his land such impure seeds without examination. The presence in the above mixture of so many small and very different looking seeds to the rye-grass is easily determined by the naked eye, and such a mixture should not have been bought by the farmer.

The other case was a sample of rye which had germinated very imperfectly in the field. After several tests under different conditions it was found that its germination was only 28 per cent. Though there has been great and general improvement in the quality of the seeds sold to farmers in England since the Royal Agricultural Society took the matter up on behalf of its members, it is clear that much yet remains to be done before the farmer can be sure that he is purchasing the best quality. One of the first steps that the Society took was to urge its members to obtain with their purchased seed a guarantee of its purity and germination. At that time no merchant entertained the proposal; but it has commended itself increasingly to seed merchants until now there is no difficulty in purchasing seeds guaranteed both as to purity and germination. The farmer has now himself to blame if he continues to buy bad seed.

The weather of this year (1907) has been so wet and sunless that the seed harvest has been far from satisfactory. Much of the seed failed to get fully ripe. Unripe seed is more difficult to maintain in vitality during the winter and those that survive produce but poor plants. There is good reason to fear that the general quality of this year's seeds will not be satisfactory, and really good, well-filled seeds will be scarce and high priced—and this is the case not only with English but also with imported seeds.

Seeds have been examined and tested for the Royal Parks, on behalf of His Majesty's Office of Works, and for growth in the grounds of the asylums under the London County Council.

#### DURATION OF VITALITY IN FARM SEEDS.

The experiments as to the life of farm seeds were continued this year, being the twelfth year of these consecutive annual trials of seeds harvested in 1895. This year's trials show yet a few seeds, in ten cases some remaining vitality, but only in the case of the two samples of oats is the life retained to any extent. Last year the black oats germinated 76 per cent., this year it fell to 70 per cent., while the white oats fell from 57 per cent. in 1906 to 50 per cent. in 1907. Full details were added to the diagram prepared by Mr. Güssow, and this was again exhibited at the Society's show at Lincoln.

The number of inquiries received in regard to this diagram manifests that considerable interest has been awakened in regard to the phenomena dealt with. It is not desirable to reproduce the diagram, or to publish any results until the trials are completed.

#### WEEDS.

Some of the plants reported upon were poisonous, like Meadow Saffron, from damp meadows, and *Euphorbia amygdaloides* Linn.), a spurge found in woods, which was growing in some land that had been deforested and had injured cattle feeding there. A branch of the American poison oak, *Rhus radicans* Linn. was sent from the shrubbery of a member of the Society, where it caused irritation and inflammation to some members of his family. The injury produced by this plant has been long known. It is caused by a poisonous substance called *Toxicodendrol*. The injury to the skin has been cured by the application of a saturated solution of arsenate of lead in alcohol. Energetic steps have been taken in America to prevent the cultivation of this shrub, and it would be well if its presence in our shrubberies in England were forbidden.

Some weeds believed to be injurious to stock were found to be innocent. And others found in pastures or cultivated fields were named and advice given as to their eradication.

In view of these applications it may be well to put on record some general conditions which should be kept before one in dealing with weeds. Any plant growing out of its proper place is a weed. A potato in a field of wheat, or oats in a turnip field are as much weeds as thistles or nettles in a pasture.

Plants which grow from seed, produce flower and fruit, and die within the year, like wheat, are called *annuals*. Plants, which live for two seasons, spend the first year in making and storing up food which is employed the second year in producing flowers and fruit. These, like the turnip, are called *biennials*. Plants which live for years and repeatedly flower and fruit are called *perennials*.

A preliminary step to dealing with growing weeds is to prevent their being brought on the land by using only pure and clean seed. This can now easily be done. Many seeds found in the hay or straw with which stock is fed have such firm coverings that they pass through the alimentary canal without being injured. The farm-yard manure thus becomes a medium of placing on the land the seeds of many undesirable weeds.

The problem of getting rid of annual and biennial weeds is more easily solved than practically applied. They must be hoed out or pulled up before or when they are in flower. No effort short of this can get rid of them. They produce, as a

rule, enormous quantities of small seeds, and many, like the annual *Poa* and the common chickweed seed from early spring till late autumn. If it were possible to cut them down before the seed is produced little would be gained, for the life of an annual plant is maintained until it bears seed. In this way the annual mignonette is converted into a shrub by the gardener, but whenever he permits it to flower and fruit it dies. In the same way the annual wheat would keep possession of the ground for years, though the popular notion that in time it changes into oats is baseless and absurd.

Efficient cultivation, as in the case of root crops, removes the annual weeds. But this cannot be done in cereal crops. When harvest opens up the weeds to the influence of the sun they become active in the production of seed. To prevent this it would be well, where it is possible, to run a shallow plough over the field so as to turn over the weeds and arrest their activity; and when the deeper ploughing is done later the whole of the surface vegetation would be so buried that it would be destroyed. It is obvious that the rotation of crops affords, in its courses, several opportunities for dealing with weed pests.

To deal efficiently with perennial weeds in good pastures is a serious problem. There is a great and general dislike to break up an old pasture because of the difficulty of procuring within a reasonable time a good turf. In these days, when the value of the various plants in a pasture is better known, and the power to obtain true and clean seed of high germinating quality is within the reach of every one, this danger no longer exists. There are, moreover, many erroneous opinions as to the desirable or objectionable elements in a pasture. The value of some good pasture lands in France was believed to be due to the abundance of crested dogstail. The seeding heads of that grass appeared from their great abundance in autumn to establish that they were the cause of this high quality. But it is clear that a grass which is allowed to run to seed could not have been eaten by the stock, and that the real value belonged to the close cropped grasses, other than the dogstail, which were scarcely visible. So also the late distinguished scientific agriculturist, Sir John B. Lawes, Bart., who cannot be charged with careless observation, came to the conclusion that rye-grass, which abounded in some good pastures in Hertfordshire, gave to them their high feeding value. He had a plot in one of these fields hurdled in, where he observed that rye-grass predominated. To his astonishment the rye-grass disappeared and cocksfoot, meadow-fescue, and foxtail overpowered all else. His first conclusion was that a pasture should be regularly eaten down to prevent the coarser grasses getting the mastery over the finer

and more valuable kinds. Afterwards, his attention being called to the sudden appearance of the larger grasses, he realised that they could not have grown from seed after the inclosure was made, and concluded that they were there but had been kept down by the stock, while the rye-grass being rejected by the stock made a great show in the pasture.

Similar erroneous opinions, from defective observation, are widely entertained regarding the weeds that occur in pastures. In the report of last year in dealing with a case in which the bitter taste of butter made from the milk of a cow that fed in a meadow in which spearwort (*Ranunculus Flammula* Linn.) was growing, it was said :—

“Inquiry was made as to the properties of a plant which was believed to be the cause of scour in calves, giving great trouble in rearing them. The meadow, in which the plant grew in considerable abundance, was marshy. The butter made from the milk of cows which fed in it had a decidedly bitter taste. The plant sent was spearwort (*Ranunculus Flammula* Linn.), and the injuries specified are those which would follow from the eating of this plant. All the species of *Ranunculus*, called buttercups or spearworts, possess acrid properties, and have not the slightest feeding value. They are usually rejected by animals, but young stock not infrequently eat them to their injury. Some farmers like to see buttercups in a field. They consider them to be the sign of a good pasture. They no doubt show that the soil is fitted to grow plants, but every buttercup is a distinct injury to the pasture. Being rejected by the stock they flower and seed in abundance. Their numerous seeds are well protected and remain ready to germinate under favourable conditions. Some of the most acrid increase by creeping stems that run above ground or in the soil. The pasture becomes more and more filled with yellow buttercup, and it loses half its value by the presence of acrid plants which causes every year injury to, if not the death of, some animals. It would be better and more profitable where land is burdened with buttercups to plough it, carefully clean it, take at least one root crop off it, and then sow it with grasses and clover, pure in quality and of good germination. Properly sown down and generously treated, a good feeding pasture has thus been secured within a year of the sowing.”

In August last a member of the Society complained of this statement in a letter which he has given leave to be printed with this report :—

“I do not feel justified in letting the short article on ‘Buttercups in Pasture,’ on page 258 of the last Journal of the R.A.S.E. pass without comment.

“To advise farmers ‘who have many, or burdened with buttercups in meadows, to plough them up, carefully clean them and take at least one root crop off and then sow with grasses and clover,’ is not good ‘Practice with Science.’ I could take the writer to hundreds of meadows which have large quantities, even ‘burdened’ with them, and are readily let at from thirty to fifty shillings per acre, the herbage of which will either fatten a bullock or enable a cow to give produce of the best quality.

“They are also during the year closely grazed and no harm comes to the stock. Many farm agreements have a clause in them prohibiting the ploughing up of old pasture under a penalty of £50 per acre.

“Apart from such a clause the cost of ploughing, cleaning, and cultivating the root crop would make the method advised impracticable. The *Ranunculus* which grows on marshy ground is no doubt bad for young stock and may



occasionally injure them. These plants might be destroyed. To plough up such land would of course be out of the question.

"The *Ranunculus* which abounds in many good pastures is well known to lose its acridity when made into hay, and I have never yet heard of a hay dealer objecting to this plant. If you were to plough up as directed, many fresh plants would spring up in the new grass from dormant seed and the meadow would be as full of buttercups as before, but minus the good and valuable turf. Animals reject these plants when freshly in flower, but as the season advances they gradually eat them, hence the bare state of the meadow (when properly grazed) in the autumn.

"*Ranunculus bulbosus* is the most general in ordinary pastures. This is commonly kept in check by rooks which grub them out and eat them. *Repens* and *acris* are not so common."

The writer allows that *R. Flammula* is no doubt bad for young stock, in the case mentioned it was bad for a milch cow. This particular case in the report was made the occasion of a warning as to buttercups in pastures. It is well known that buttercups lose their acridity in hay, but no one doubts that when the plant is growing in the field it is acrid. That in good pastures buttercups abound is unhappily too true, but every buttercup in a pasture is a defect. It is a weed where a good grass should be, and more, it is a dangerous weed which, if swallowed in any quantity by the feeding animal may, as it has often done in the past, cause injury. The assertion that ploughing and resowing a meadow—not where *Ranunculus Flammula* was growing, which was not suggested, but—where buttercups abound is not good "Practice with Science" needs some modification.

#### DISEASES OF PLANTS.

The damp and cold summer was most favourable to the growth of fungi, and a considerable number of inquiries were received in regard to injuries caused by these parasites.

Toadstools, species of *Agaricus*, have been frequent in lawns. They find in the humus of the soil sufficient food for their nourishment and do not injure the vegetation.

Several cases of rust on the leaves of the pear tree were reported upon, and of the earlier stage when it lives on the common saviue, *Juniperus sabina* Linn. Peach leaves attacked by *Eroascus deformans* Berk. causing leaf curl, were received and treatment recommended. The leaves of black currant were injured by *Glæosporium curvatum*, commonly called shot hole fungus from the roundish holes it makes in the leaves. It is deserving of notice that, although the dreaded disease of the American Gooseberry Mildew is still present in localities from which it was sent last year, no specimens have reached the laboratory.

A crop of sainfoin was destroyed in patches, and it was found that the injury was caused by the fungus *Sclerotinia ciborioides* Rehm, well known to cause sickness in red clover.

Two injuries to broad beans were investigated. The leaves in one case were covered with numerous small orange-coloured pustules, being the fruiting stage of *Uromyces fabae* Pers. No serious damage results from the attack of this fungus. The other case was an injury to the stems of beans from a field in Norfolk. The attack had begun in the root and passed up into the stem, suggesting the disease of blackleg in the potato plant. The parts killed in both the root and stem were filled with a greyish slimy substance swarming with innumerable very minute rod-like bacteria. The bacterium was isolated and cultivated on sterilised carrot. It grew freely, forming gelatinous, dirty white colonies. From these the bacteria were transferred on a needle to young seedling beans. The bacteria began to multiply, and in four days the blackness of the rootlets and the stem as in the original specimens made its appearance. The examination of the blackened tissues showed that the injury was due to the same bacteria. A further experiment was made to test whether this bacterium of the bean was the same as that causing blackleg in potato. Bacteria from the beans were transferred to healthy potato tubers which were planted in the soil. The shoots that were developed were healthy, but after direct infection of the shoots the disease appeared and they were killed. These results may not be sufficient to determine the identity of the bacterium causing blackleg in potatoes and in beans, it nevertheless establishes that the potato may be infected by the bacterium from the bean. It is therefore well that caution be exercised when an attack of blackleg appears in a crop of either beans or potatoes, neither plant should be the succeeding crop.

Two diseases, hitherto unknown in England, affecting potatoes have been investigated. Some tubers had been stored in a somewhat moist place. In a short time there appeared patches of a dark mould, composed of short olive green bristles. The tissues of the potatoes underneath these patches were brownish coloured. The fungus was found to be *Stysanus Stemonitis* Corda. This has been hitherto considered as growing only on dead organic matter, but the experiments recently conducted at the German Biological Station at Dahlem have proved that the fungus produces rot in potatoes, which spreads from tuber to tuber when stored in pits. It is also reported from America that the brown disease in potato is caused by this fungus. The spores have readily germinated in the laboratory on healthy tubers which were soon covered with the dark mould. The accompanying illustration (Fig. 1) shows the fungus greatly magnified (A, B), and the spores still more magnified (C). Well-ventilated pits will greatly hinder the growth of this fungus.

The other disease manifests itself in raised spots of varying size on the surface of the tuber (see Fig. 2). At first the epidermis covers them, but by and by the skin bursts and exhibits an olive-green powder, giving to the potato a scurfy

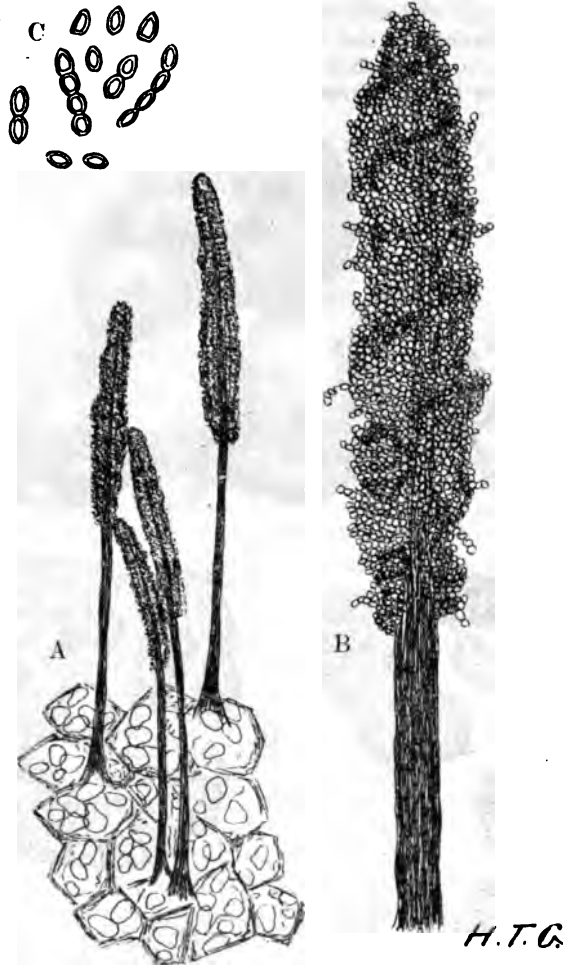

FIG. 1. *Stysanus Stemonitis* Corda. A. Four fruiting bristles. B. The fruiting head. C. Ripe spores. All magnified.

appearance. The powder under the microscope is found to be the spore balls of the slime fungus *Spongospora Solani* Brunch. These balls form irregular roundish or elongated hollow bodies,

having somewhat the appearance of a minute sponge, hence the name given to the fungus. The disease was first observed by Brunchhorst, in Holland, in 1886, and has been detected thereafter in several European countries. It has been noticed and has been described by Professor Johnson, of Dublin, in 1906. Though the disease and its cause are known, there has yet to be discovered the manner in which the fungus obtains entrance into the tuber and develops there. Experiments instituted for this purpose are being prosecuted.



FIG. 2.—Tubers of potato attacked by *Spongospora Solani* Brunch.

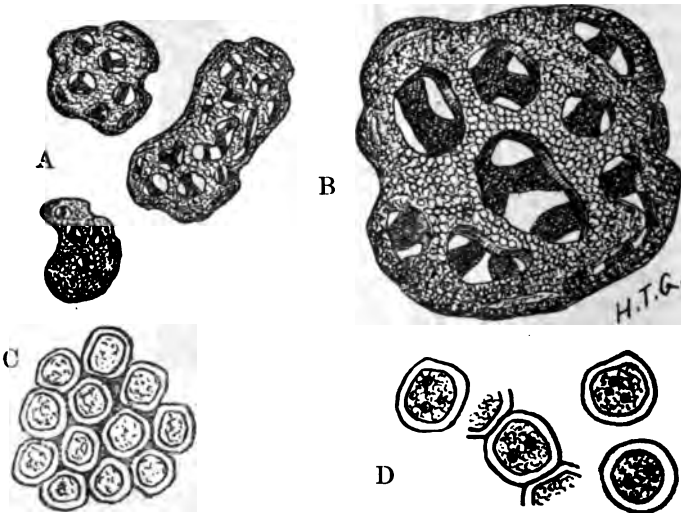

FIG. 3.—*Spongospora Solani* Brunch. A, Spore balls magnified. B, A spore ball more highly magnified. C, Mass of single spores. D, Separate spores, treated with staining reagents.

Diseases on pines, larches, and Douglas firs have been investigated, which have been described in former reports.

Injuries to alsyke, white clover, broad beans, and wheat were traced to the severe frosts of early spring. As a rule the plants get over such injuries.

Advice was asked by a member as to the cultivation of hemp for fibre, and instructions were given as to the most improved methods.

A feeding cake seriously injured by moulds had undoubtedly caused injury to stock.

WILLIAM CARRUTHERS.

The Laboratory,  
44 Central Hill, Norwood, S.E.

---



---

## ANNUAL REPORT FOR 1907 OF THE ZOOLOGIST.

### INTRODUCTION.

THE peculiar weather conditions which prevailed during almost the whole of the past year were very faithfully reflected in the applications for advice received by the Zoologist. During the spring there was little especially noticeable except that the ordinary pests seemed to be appearing somewhat later than usual. The only pest of special importance was the pygmy mangold beetle, *Atomaria linearis*. This insect was recorded by the late Miss Ormerod in 1892, and did not attract attention again until the last year or two; but as it probably occurs much more frequently than is suspected, and as it is entirely unknown to most farmers, a fuller notice of it is given in the following pages.

After a late spring followed an unusually wet summer, and this was marked by an unwonted number of complaints of caterpillar attack on fruit and foliage trees. A variety of other pests were reported, but it was particularly by caterpillar plagues that the prolonged period of rainy weather was signalled, and it was noticeable that not only the familiar species, such as the winter moth, were more active than usual, but that many common caterpillars of the Tortrix or "leaf-roller" group, whose work is ordinarily unimportant, became on this occasion seriously destructive.

Late in August a remarkably dry spell of weather set in, and during the autumn some pests which are generally associated with particularly dry seasons made a somewhat belated appearance.

During the year many Members sought advice with regard to creatures infesting stored produce and buildings, and though this is no doubt accidental and without special significance the opportunity has been taken of giving some account of the principal insects and arachnids which are likely to be found in such situations.

#### THE PYGMY MANGOLD BEETLE (*Atomaria linearis*).

This minute beetle was first recorded as a pest to mangolds in England by Miss Ormerod in 1892, though that writer believed that many previous failures of mangold crops hitherto unaccounted for had in reality been due to the same cause. It next attracted attention in 1904, when Mr. F. V. Theobald recorded it in the first British Museum Report on Economic Zoology, and it has since been reported from Buckinghamshire, Devonshire, Huntingdonshire, Hampshire, Shropshire, and Somersetshire. In May last my attention was called to a bad attack in Essex. It would seem, therefore, that the pest is either very much on the increase, or that the real cause of mangold failure has very often remained unrecognised in the past, which, as will presently be seen, is extremely likely. In either case it is desirable that root growers should become more familiar with this insect, possessed as it is of great destructive powers.

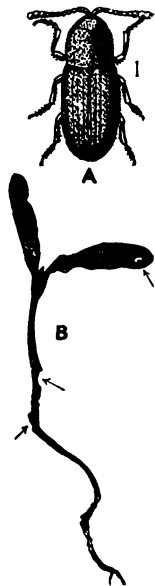

FIG. 1.—  
A. *Atomaria linearis*.  
B. Injured mangold plant.

Its very small size (it is about one-sixteenth of an inch in length) and its nocturnal habits render it very likely to be overlooked by the farmer, who on visiting the crop by day sees nothing to account for its failure, and if he sends specimens of the injured plants to an entomologist, none of the beetles are included in the sample, or they escape before examination, so that it is extremely probable many cases of this attack have been attributed to wire-worm or millipede. Such mistakes are not likely to occur in the future now that it is known that the insect is widely distributed and the distinctive characters of its work are sufficiently familiar to at once suggest the real cause of injury.

*Nature of the injury.*—The beetle appears in May and June, and attacks the germinating mangold seed, and more or less destroys the crop before it comes above ground at all. Such plants as succeed in putting forth seed-leaves are attacked in two ways. The beetles bite holes in the seed-leaves, but they inflict much more serious injury on the root, the places

where they have been at work showing blackened spots. Frequently they bite the plant almost through near the ground surface. The crop may thus be entirely destroyed, and the farmer, visiting it by day, sees nothing to account for the disaster. If he pulls some of the plants up the two or three minute beetles which may be clinging to the roots may very well escape his notice, and if he sends them to an expert for examination the very active insects will almost certainly have escaped before the plants reach their destination. If, however, he knows what to look for, and lifts some of the damaged seedlings with their accompanying soil, the beetles soon betray themselves by crawling about. If the crop be visited at night multitudes of the insects will be found above ground. Thus, if it is once recognised as a likely cause of mangold failure, there is no difficulty in determining its presence in any given case. The trouble in the past has been that it was so little known as not to suggest itself as the cause of injury, and so small and elusive as to escape observation when the crop was examined, or when injured seedlings were sent for expert examination.

Clearly this pest deserves more attention than it has yet received, for nothing seems to be definitely known of its life-history. We require in the first place to ascertain the frequency of its occurrence, and the circumstances—of weather and of crop rotation—under which it generally appears. It is especially necessary to find out where and how it lives in the intervals between mangold attacks.

In cases of a pest such as this, which is better known in other countries than in England, we are naturally anxious to benefit by the experience of our neighbours, but with regard to the pygmy mangold beetle they give us little assistance. The information derivable from foreign entomologists may be summed up as follows :—

1. The circumstances which seem to favour the attack are a light gravelly soil and prolonged dry weather. (The latter circumstance was certainly wanting in the Essex attack last May.)

2. The beetles are sometimes found infesting dry dung, and may therefore be sometimes conveyed to the crop in farmyard manure. It seems likely, therefore, that the substitution, as far as possible, of chemical manures would be beneficial.

3. Where the beetle is known to occur, extra thick seeding and stimulating manures are recommended.

4. Kirchner recommends impregnating the seed with five parts sulphate of magnesia and one part carbolic acid in one hundred parts water for twenty minutes. [Das impregnieren der Rübenknäul mit 5 teil schwefelsaurer Magnesia 1 teil Karbolsäure auf 100 teile Wasser (20 minuten lang).]

5. The beetle is most injurious where sugar beet is grown year after year, so that the ground does not get the benefit of a proper rotation. The difficulty is partly met by sowing the beet in *patches*, and planting out. The patches

are changed from year to year and the risk to the seedlings minimised, while the plants placed in the previously infested ground are strong enough to resist any but a very severe attack.

Mangold and beet are the crops attacked, and even Kaltzbach, who has investigated the insects occurring on a large number of plants whether of economic importance or not, mentions no other food-plant for this beetle. Most of our pests, however, are able to maintain themselves on weeds in the intervals between the successive appearances of the farm crop they attack, and if this is the case with *Atomaria* we should naturally look to the "goosefoot" weeds to explain its existence when not in evidence on the farm, for these are the nearest allies of beet and mangold. Many of them are distinctly sea-side plants, and it would be interesting to know whether mangolds are attacked more frequently in districts neighbouring the sea than in those further inland.

#### PESTS INFESTING BUILDINGS AND STORED PRODUCE.

An unusual number of complaints have been received during the past year with regard to creatures infesting stored produce, or occurring in such numbers as to be a nuisance in granaries, out-houses, and dwelling rooms. Samples of stored corn were infested by various beetles, including *Calandra granaria*, *C. oryzae*, *Sylvanus surinamensis*, and *Cryptophagus badius*, the last probably an accidental visitor, as it is commonly found in cellars. Stored food-stuffs contained *dermestes lardarius* and *Sitodrepa panicea*. The curious "rat-tailed" grubs of *Eristalis tenax* were found in cow-sheds in such numbers as to cause alarm. A granary was infested by bird parasites derived, presumably, from a neighbouring pigeon house. A haystack was reported as harbouring incredible numbers of the mite *Tyroglyphus longior*, and in other cases the allied mites *Glyciphagus domesticus* and *G. spinipes* were accused of infesting dwelling rooms and getting into everything that could afford the smallest modicum of nutriment. All these in addition to such familiar pests as meal-worms, clothes moths, cockroaches, and rats and mice.

Such pests are not of equal importance with those attacking growing crops, but they are often the cause of great annoyance and no inconsiderable loss. Most of them are good examples of the way in which the operations of civilisation disturb the balance of nature, for, finding abundance of food and shelter provided for them, their habits have been modified, and their reproductive powers enormously increased.

The familiar grain weevil, *Calandra granaria*, which has entirely adapted itself to an indoor life, perforates the individual grains of corn with its long proboscis and inserts an



egg in each. The grub which results hollows out the grain and goes through all its changes within the husk. The weevils are very prolific, especially in a warm granary, so that the introduction of a very few of them may result in quite considerable destruction of grain in the course of a few months. The rice weevil, *C. oryzae*, introduced from India, has now spread all over the world, and is almost as common in grain as *C. granaria*, which it very closely resembles, though it is not difficult to distinguish them. The punctations on the thorax (or fore-body) of *C. granaria* are linear, while they are circular in *C. oryzae*, and the latter has four reddish spots on the wing covers. It is also more catholic in its tastes, and infests many stored products besides grain.

Another little beetle which is widely spread in stored grain and other produce is *Silvanus surinamensis*. It is very minute—only the tenth of an inch in length—and cannot be mistaken for either of the *Calandras*, as it has no proboscis, and the fore-body is toothed along each side. Its grub is active, and instead of living within the grain it moves about and attacks many different grains from the outside.

*C. oryzae* and *S. surinamensis* are thus to be found in various food-stuffs besides grain, and in one case a third beetle was complained of—*Sitodrepa panicea*. This has been variously called the “drug-store beetle,” and the “bread beetle.” It has remarkable tastes, chamomile, red pepper, tobacco, ginger, and old books being among its favourite foods, though it does not despise flour and meal. It is a very small oval insect—about the tenth of an inch long—and the covering of its fore-body forms a sort of hood.

A comparatively gigantic beetle often found infesting stored goods of a fatty nature, such as bacon or cheese, is *Dermestes lardarius*, the “bacon” or “larder beetle.” It is easily recognised by the characteristic markings on its wing-covers, and its extremely hairy grub is not likely to be mistaken for anything else.

Occasionally microscopic Acarines of the “cheese mite” tribe (*Tyroglyphidæ*) are found infesting all kinds of stores, and even wandering at large about dwelling rooms. *Glyphagus domesticus* is the usual culprit, though *G. spinipes* has similar habits. These mites are exceedingly small creatures of a whitish colour which run about actively. They generally first occur in some neglected parcel of food material which has been left lying about, and they may increase to such an astonishing extent as to permeate the whole place. They do no great harm, but their presence is very naturally objected to.

There are two mites to which the common name of “cheese mite” is applied, as both almost equally infest decaying cheese.

They are *Tyroglyphus siro* and *T. longior*. A remarkable case was reported in September where the latter species was present in such enormous numbers round a clover stack as to attract the attention of the owner. They may always be found if searched for in such situations, but seldom occur in sufficient numbers to be noticeable. The circumstance is not unprecedented however, for Michael in his monograph mentions having seen a stack which appeared to consist quite as much of mites as of clover, and which was absolutely ruined by creatures so small as to be only just visible without a microscope.

*Treatment.*—The circumstances under which these different pests may appear are so various that it is impossible to devise a remedy which will fit every case. They have one point in common, however, for the trouble nearly always begins through neglecting to remove waste material from granaries or store rooms. Waste corn or meal left lying about is a danger to the mill or granary, and in the same way moth or beetle-infested clothing or food in a house, unless speedily removed, may lead to the whole building becoming infested. The first care, then, is to search for and destroy the material which has given rise to the particular attack. Other measures will necessarily depend on the circumstances.

For stored grain or any material which can be placed for treatment in a closed bin, carbon bisulphide is the most effective insecticide in the hands of one who can be trusted to use it with the necessary caution. It is placed in open vessels on the top of the infested material in the bin, and the lid tightly closed down. Its fumes permeate all the material with fatal results to every kind of insect life. The fumes must not be inhaled by the operator, and it is most important that no light should be brought near till the smell has quite passed away after opening the bin, for the bisulphide is extremely inflammable.

There are cases which can be best dealt with by the application of heat—by stoving or baking the infested matter. In last year's report the results were given of some experiments on the temperature necessary to kill certain mites without injury to the material in which they occurred.

If a larder or store-house becomes infested by any of these household pests it is best to have it thoroughly cleaned out and washed as far as possible with dilute carbolic acid. Spraying with benzine is sometimes recommended.

The bacon beetle can be specially troublesome in a larder or a grocer's store if its first appearance is not immediately noted. Its occurrence on a ham or a side of bacon is not in the least an indication of unsoundness; it only demands food of a fatty nature. If observed at once the attacked portion may be

cut away and destroyed. It is frequently a puzzle how it obtains access to hams apparently securely tied up in bags, but it is not necessary that there should be a hole large enough for the beetle to pass through. A very small aperture will admit the young grubs, and near such a hole the beetle will lay its eggs. All insects preying on stored goods seem to have this instinct. Blow-flies will drop their eggs through the wire gauze of the meat safe. I have seen an apparently hermetically sealed specimen-box of wheat swarming with weevils and every grain destroyed. There was certainly no hole large enough to admit the weevil, but the glass top was not absolutely tight, and there was just room for the newly hatched larvæ to crawl in. It is worth knowing that furs put away clean in newspaper wrappings are safe from the moth if the paper is free from holes and all the junctions are closed by gumming. The moth cannot pierce the paper, but it will take advantage of the slightest opening by which its caterpillars may enter.

A few years ago the owners of flour mills throughout the country were greatly troubled by the "Mediterranean flour-moth," *Ephestia kühniella*, the grubs of which choked up the

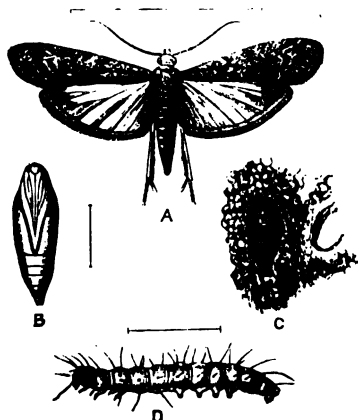

FIG. 2.—*Ephestia kühniella*.—A. Imago. B. Pupa. C. Pupæ in situ. D. Larva. A and C. from nature; B and D. after Riley.

bolting reels and elevators with their webs and rendered frequent closing down and cleaning out compulsory. So great was the nuisance in American and Canadian mills that, after a large expenditure on experimental treatment, the absolute eradication of the pest was almost despaired of, and the measures adopted against it took rather the form of automatic cleaning apparatus in the parts of the machinery liable to attack. I have not lately received any complaint of this

moth, whether because it is less common or because it is regarded as inevitable, it would be interesting to know. An account of it appeared in the Zoologist's report of 1903.

It sometimes happens that alarm is caused by the presence of large numbers of insects of unfamiliar appearance in stables or cow sheds. Such a case was reported from Truro in July, and as other Members may meet with a similar experience it may be alluded to here. The creatures were well described as grubs "of a dull grey colour, walking about like caterpillars, but with a long tail. They appear to hang themselves by the tail in any suitable crevice in walls or doors, and are very abundant in all the cattle houses here."

The creatures in question were the grubs of the "drone fly," *Eristalis tenax*, an insect very closely resembling the honey-bee, and perfectly harmless. Their presence in such localities is accounted for by the fact that the grubs live in liquid filth, and their long tails (which cause them to be known as "rat-tailed larvæ") bear the breathing orifice, which can be kept above the surface while their bodies are immersed in the manure in which they breed. When climbing the walls they were fully fed and ready to turn to chrysalids. Their bee-like appearance probably gave rise to the very ancient belief that honey bees could originate from "carcasses" or other decaying matter. They do no harm in the cow sheds, and in green-houses, where they often appear in the autumn, it has often been asserted that they are largely instrumental in cross-fertilising certain plants—especially chrysanthemums.

#### NURSERY GARDEN PESTS.

Rather a large number of the pests inquired about during the past year were injurious to the garden rather than to the farm, though, except where flowering plants are concerned, the distinction is perhaps unimportant. The increasing frequency of a not very familiar rose pest deserves mention, and there are other injurious insects to which the very mixed produce of gardens renders them especially liable.

Many pests attack the rose, and some, such as the aphid, the yellow saw-fly, and the green rose-beetle (*Cetonia aurata*), are familiar to most growers. The black saw-fly (*Blennocampa pusilla*) is less well known, but it has occurred rather frequently of late on cultivated roses. The attack may be recognised at once by its effect on the bushes, for the young caterpillars, by their feeding, cause the leaves to roll up in a cylindrical fashion, giving the plants quite a characteristic appearance.

The saw-fly is a very small insect, only one-seventh of an inch long, with a span of about one-third of an inch across the

wings, the body black, but the tips of the legs whitish. It appears in May and June, and lays its eggs on the rose leaves, choosing by preference the wild rose, or even blackberry bushes. In the garden it is those varieties which approach most nearly to the wild type which generally suffer most, though the attack is not confined to them. As is usual with saw-flies the caterpillars, when fully fed, go down to the ground to pupate, and it is this habit which renders saw-fly pests among the easiest to deal with, for the winter is spent on or beneath the surface of the ground under the plants they attack, and there is ample time to take measures for their destruction before the flies come out in the following spring. The first thing is to remove and destroy all dead leaves or other shelter in which the pupæ may be hiding, and it is well to take away the surface earth to the depth of an inch or two and bury it deeply, substituting fresh soil for it. Or the soil beneath the plants may be dressed in winter with some substance likely to kill the chrysalids it contains.

Mr. F. V. Theobald has made the very pertinent suggestion that the pest is very likely introduced into gardens at the roots of the briar stocks used in budding for standards. This is extremely probable, and it would be a wise measure to make sure that no pupæ are imported in the earth about the roots, either by washing them clean or by dipping in a paraffin emulsion.

#### WEEVILS (*Otiorrhynchus picipes*, *O. sulcatus*).

A case of severe injury to young plantations of ash, oak, lime, and sycamore by the "clay-coloured weevil," *Otiorrhynchus picipes*, was reported from a Cheshire nursery in May, the bark being eaten away to such an extent that many of the seedling trees were killed. The weevil is a common one, and, in company with an allied species, *O. sulcatus*, is often accused of causing injury in gardens, especially to raspberry and strawberry plants and vines. That it is very catholic in its tastes - was well exemplified in another instance during the summer. Some Michaelmas daisies were seen eaten away in a very characteristic manner, so that they showed numerous slits more or less parallel to the lateral veins. Nothing could be found on or near the plants by day, and it was only by visiting the plants with a lantern at night that the cause of injury was discovered, numerous weevils being then seen at work on each leaf. Most of them were *O. picipes*, but a few of a larger species, *Barynotus obscurus*, were present.

In the day time the insects take refuge in the ground, where their earthy colour enables them to escape observation. In dealing with them it is well to take advantage of this habit, for immense numbers may be caught by shaking them off into

suitable receptacles at night. The operation must be rapid, for many let go and fall to the ground very soon after the light is flashed upon them. This plan, repeated a few times, was entirely successful in clearing the Michaelmas daisies, and is certainly the best where practicable, but it might be well to supplement it in the case of infested tree plantations by suitable dressings. Kainit would probably be useful, as it would benefit the trees, while the salt it contains would be obnoxious to the weevil.

It is *O. sulcatus* which does most injury to vines, biting through the leaf stalks and littering the floor of the vinery with leaves. Here again the pest is seldom seen unless sought for at night, when it can be found at work and shaken down. Precautions must further be taken to prevent the ascent of the weevils, which cannot fly but have to crawl up the stems or the walls to reach the leaves. It is generally possible to stop them effectively by banding the trunks and strewing ashes soaked in paraffin along the foot of the wall.

#### PINE SHOOT TORTRIX (*Retinia buoliana*).

This is another plantation pest of special interest to nursery gardeners, as it prefers young trees of Scotch pine, and more than one complaint of its ravages was received during the past year. The injured shoots have a characteristic brush-like appearance, and if opened at any time during the winter months a brown caterpillar is found within. The very prettily variegated moth, reddish-yellow in colour with silver streaks, and about an inch across the extended wings, comes out in June, and it is important that they should be picked off and burnt before the end of May, otherwise the disease is sure to spread. There is no way of saving them, for the caterpillar is too securely hidden to be reached by any wash, and the sole object of the gardener is to prevent the moth from emerging and laying eggs on new shoots.

#### CELERY FLY (*Tephritis onopordinis*).

This is a dry-weather pest, and as the fly normally appears in May, it seemed hardly likely that it would be particularly troublesome during the past year. Nevertheless some celery beds developed the disease severely during the warm weather of the late summer and autumn. There is no need to re-describe so familiar a pest, but it may be mentioned that the fly lays its eggs on the leaves of celery and parsnips, and that the grubs which hatch out "mine" the leaves, causing them to be blistered with brown patches.

On the small scale pinching the blistered leaves with the gloved hand is recommended, but it is much quicker—and scarcely more injurious to the plant—to remove them altogether

and burn them. No doubt the plant is weakened, but at all events the grubs so destroyed will not become flies and do injury in the future.

For treatment on the large scale various dressings have been tried in order to prevent the fly from laying its eggs. The grub within the leaf is unharmed, but further attack may be more or less forestalled. Soot is fairly effective, but better results have been obtained by a mixture of soot, lime, and earth. The plants should be liberally watered in dry weather.

**.ROOT-KNOT EELWORM (*Heterodera radicum*).**

Complaints were again received of damage done to cucumbers by this troublesome pest, which causes little galls or swellings on the roots, giving them an appearance recalling the disease known as "finger and toe." Tomato plants also suffer from the disease.

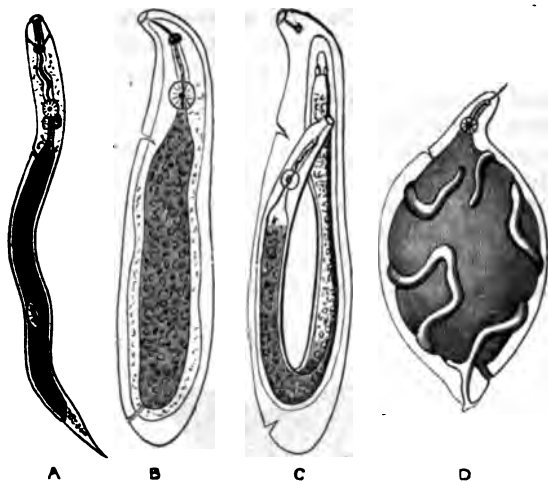

FIG. 3.—Development of *Heterodera radicum*, after Ritzema Bos. A. Young eelworm, or larva. B. The same after having buried itself in the root. C. Developing male. D. Adult female.

This eelworm is essentially a soil pest, that is, it is present in large numbers in infested soil, where it can remain alive for a long time, ready to penetrate into any tomato or cucumber root which it finds at hand. It is therefore fortunate that cucumbers are generally grown in definitely circumscribed areas of soil, for they can be treated much more satisfactorily than would be possible with crops grown in the open. If cucumbers fail for no apparent reason some of the roots should be examined for this pest, and the swellings, if present, will at once be recognised. Badly knotted roots should be removed

and burnt, and something must be done to clear the soil of the worm. For this purpose carbolic acid has proved very effectual, and the amount to be used is governed not by the superficial area but by the cubic content of the soil, which can readily be roughly estimated in the case of a frame. Two ounces of carbolic per cubic foot of earth is generally sufficient to eradicate the pest.

#### CATERPILLARS.

The impetus given to various caterpillar attacks by the wet weather in June and July was very marked. Complaints were heard on all hands of fruit and garden trees having their foliage destroyed by these pests, and from the specimens sent it was evident that the recognised orchard enemies were by no means the only ones at work. Indeed, in many cases the winter moth caterpillars were greatly out-numbered by various species of "leaf-rollers," the larvæ of the group of moths known as *Tortricidæ*. Several of these are common enough, and to be found in every garden, but it is seldom that they do as much harm as was the case during the past season. These exceptional attacks furnish no reason for relaxing the precautions to be taken against the winter moth, which is a constant pest, while the leaf-rollers only occur spasmodically in injurious numbers. The life-history of the winter moth is well known, and its green, white-lined, looper caterpillar easily recognised, and all fruit-growers know that its practically wingless female can be prevented from climbing the fruit trees to lay eggs by banding early in October. But this measure



FIG. 4.—A, Male Winter moth. B, Female, natural size. C, Caterpillar, enlarged.

does not, of course, deter such moths as the *Tortricidæ*, which can fly perfectly well, and the fruit-grower ought to be ready with an arsenic wash, in the Spring, to be used in case of need, and without loss of time. Its object is to kill the caterpillars by poisoning their food, so that it is only used if the pest is already at work, but the earlier the attack is noticed the more efficacious the treatment. Moreover, at a later stage the



curling of the leaves prevents the grubs from being easily reached. These "leaf-roller" moths are all very similar in their life-history, and the particular species has no great interest for the fruit-grower, but it may be mentioned that in the cases referred to three species were especially prevalent, *Lozotaenia rosana* on various garden and fruit trees, *Tortrix ribeana* and *Antithesia pruniana* especially on apples and plums.

The safest and most convenient spray is, perhaps, the following :—Dissolve six ounces of arsenate of soda in a little water, and pour this into 100 gallons of soft water. Also dissolve eighteen ounces of acetate of lead ("sugar of lead") in a little water, and pour the solution into the 100 gallons containing the arsenate of soda. Stir frequently, and deliver as a fine spray. Soft soap may be added with benefit. There may be no need for spraying at all, but it is very desirable to have the ingredients ready in case of emergency, so that the wash can be immediately made and applied.

#### SNAILS AND SLUGS.

Of these troublesome and familiar garden pests there is nothing new to say except that probably much more might be done than is done at present in the way of collecting them with a lantern at night. Very large numbers might be destroyed at slight expense if paid for by the pint, as boys would enjoy the fun. Acetylene bicycle lamps are excellent for the purpose. Certainly in a garden they soon become conspicuously reduced by a few determined raids upon them in this way. I have found attempts to trap them somewhat disappointing, especially if there are hedges at hand in which they can hide, but a good many can be caught by a bait of "brewers' grains."

Of the materials used to keep them off plants, wood ashes are the most effective. Soot and lime are of some slight use, but by no means furnish impassable barriers.

A good many of the curious *Testacella* slugs were found during the past year, especially on asparagus beds. They should not be destroyed, as they are carnivorous, feeding chiefly upon earthworms. It may be recognised by the little ear-shaped flat shell at its hind end. It is capable of great elongation, and its habit is to pursue earthworms down their burrows as the weasel pursues the rabbit. The object of the shell is believed to be to protect the slug so engaged from an attack in the rear by another testacella which may be seeking an earthworm down the same burrow.

CECIL WARBURTON.

Zoological Laboratory,  
Cambridge

VOL. 68.

R

THE WOBURN EXPERIMENTAL  
STATION OF THE ROYAL AGRICULTURAL  
SOCIETY OF ENGLAND.

	PAGE
FIELD EXPERIMENTS, 1907 . . . . .	242
CONTINUOUS GROWING OF WHEAT AND BARLEY . . . . .	242
<i>Alterations in Plan of Experiments</i> . . . . .	242
<i>Continuous Wheat (Stackyard Field), 1907</i> . . . . .	245
<i>Continuous Barley (Stackyard Field), 1907</i> . . . . .	250
ROTATION EXPERIMENTS, 1907 . . . . .	251
GREEN MANURING EXPERIMENT, 1907 . . . . .	257
NITRATE OF SODA AND SALT FOR MANGOLDS, 1907 . . . . .	257
LUCERNE, 1907 . . . . .	258
VARIETIES OF LUCERNE, 1907 . . . . .	259
GRASS EXPERIMENTS, 1905-7 . . . . .	259
1. <i>Laying Down Pasture, 1906-7</i> . . . . .	259
2. <i>Improvement of Old Pasture, 1905-7</i> . . . . .	261
RAINFALL AT WOBURN, 1907 . . . . .	264
POT-CULTURE EXPERIMENTS, 1906-7 (Summary) . . . . .	264

FIELD EXPERIMENTS.

CONTINUOUS GROWING OF WHEAT AND BARLEY.

*Alterations in Plan of Experiments.*

THIRTY years having elapsed since these experiments were commenced, the conclusion of the harvest of 1906 afforded a favourable opportunity for reviewing the work of the past, and for considering in what ways, if any, alterations in the plan of experiment might, with advantage, be made. I was accordingly requested by the Chemical and Woburn Committee to go into this matter and submit any proposals I had to make. This I did, and the suggestions meeting with the Committee's approval, were carried into effect as from the crops of 1907.

It will be within the recollection of many that the Woburn Field Experiments were originally designed (in 1876-77) to supplement the older Rothamsted Experiments of Lawes and Gilbert, and, inasmuch as the latter were conducted on a heavy soil, the light sandy soil of Woburn was chosen for the new series, and to enable an answer to be given to the oft-asked question whether the striking results brought out in the Rothamsted Experiments would be found to hold good on a soil of totally different character. It is now a matter of history that the results of the Rothamsted Experiments have found

a confirmation in general respects in the experience at Woburn. At the same time certain differences have been brought out between the two places which have rendered the confirmation of the work very desirable. Chief among these is the influence of lime in the soil, the Woburn land being very deficient in this constituent.

Having thus a common origin, it was both natural and desirable that, when the Woburn Experiments on the Continuous Growth of Wheat and Barley were begun, the manurial plan adopted should be much the same as that of Rothamsted. Certain modifications and amplifications of the latter, which experience had shown to be desirable, were made, but, in the main, the same line of inquiry was followed. In this way it came about that the manurial treatment was independent of "cost," the object being to see what the different fertilisers used were capable of producing, apart from the variations caused by market changes in the purchase of manures or sale of produce. It was sought to establish data for calculating what increase of produce might be expected from the use of this or that constituent, rather than to determine directly what would "pay." So it happened that materials of comparatively recent introduction, such as sulphate of ammonia and nitrate of soda, were employed in quantities which, to the present-day farmer, with corn hardly a "paying" crop at all, may seem prohibitive. Further, in the case of compound manures, the idea was mainly to supply *all* the constituents that the crops might require, so that failure should not be due to the absence of any one or other, and that the differences in crop results should thus be attributable directly to the difference of manurial treatment. Accordingly, under "mixed mineral manures" were included superphosphate of lime, sulphate of potash, sulphate of soda, and sulphate of magnesia, these supplying phosphoric acid, lime, potash, soda, magnesia, and sulphuric acid, with small quantities of iron, alumina, silica, &c.; similarly "ammonia salts" comprised not sulphate of ammonia alone, but also muriate (chloride) of ammonia. Farmyard manure, again, was not merely what was taken out of a yard, but was box-made manure for which definite quantities of cake, corn, roots, and chaff were consumed and known weights of litter used, so that, the nitrogen contents being approximately known, a fair comparison could be made with nitrogen in the other forms of ammonia salts, nitrate of soda, and rape dust.

Since these experiments began a good deal more knowledge has been collected as to the action of different manures and constituents of manures, and the conclusion of the thirtieth year of continuous cropping afforded a suitable opportunity for reviewing the original plan in the light of the experience

gained. It has also to be allowed that the fact of the manurial applications being, in many instances, out of proportion to what the farmer could profitably employ—under altered conditions of corn-growing—militated not inconsiderably against the ready acceptance of the experiments by the “practical farmer,” and placed them, as it were, beyond his reach.

Without admitting that this complaint was justified, and while maintaining that scientific inquiry must, in many cases, be carried on independently of direct cost or return, it was felt by the Committee that if the plan could be revised in some respects so as, without destroying their scientific value, to commend them more fully to the practical man, this would be very desirable. In this sense marked modifications were introduced when entering upon the fourth decade, and these will now be briefly noted.

1. In place of ammonia salts (this being a mixture, in equal parts, of sulphate of ammonia and muriate of ammonia) sulphate of ammonia alone is now employed, experience having shown that muriate of ammonia cannot be considered a regular article of commerce for manurial use; moreover, the action of chlorides on such a soil as that of Woburn is likely, in the long run, to have an influence the reverse of beneficial.

2. The rates at which nitrogen is used in its various forms of sulphate of ammonia, nitrate of soda, and rape dust have been considerably reduced and brought within practical limits. Previously the smallest application of nitrogen was equivalent to 50 lb. of ammonia per acre, represented by a dressing of about 2 cwt. per acre of sulphate of ammonia, or  $2\frac{1}{2}$  cwt. of nitrate of soda, while the heavier applications went up to 5 cwt. of nitrate of soda per acre. These are amounts manifestly beyond the reach of the practical farmer at the present day. The quantities accordingly were reduced by one-half, 25 lb. of ammonia per acre being used as the ordinary dressing, this being equivalent to rather less than 1 cwt. per acre of commercial sulphate of ammonia or rather over 1 cwt. of nitrate of soda. The double application (50 lb. ammonia) is retained in some instances in order to afford a comparison.

3. Mineral manures, instead of being of the former complex nature and high cost, are reduced to a general application of 3 cwt. of mineral superphosphate of lime and  $\frac{1}{2}$  cwt. of sulphate of potash per acre. The soil being light and sandy, it was deemed desirable to keep up the application of a certain amount of potash, but, experience not having shown any need for the special use of salts of soda or magnesia, these were dropped.

4. In place of an application of 14 cwt. of rape dust per acre (to yield 100 lb. ammonia) one-fourth that quantity only is now used (25 lb. ammonia per acre).

5. Farmyard manure, instead of being put on in quantity *estimated* (as the result of feeding with known foods) to yield a certain amount of ammonia, is now, while being made as before, analysed when applied, and the actual quantity required to supply 100 lb. ammonia per acre is given. This is just one-half of what had been reckoned hitherto to be supplied. Recent investigations at the farm have shown that in reality a considerably less quantity of ammonia was supplied than had been calculated to be the case.

6. Lastly, the plots 10a and 11a (on which rape dust and farmyard manure respectively had been used for several years and the application then left off for the last twenty years or so) were considered to have afforded all the information they were likely to give, and the treatment was replaced by using on plot 10a, superphosphate of lime 3 cwt. and nitrate of soda 1 cwt. per acre, and on plot 11a, sulphate of potash 1 cwt. and nitrate of soda 1 cwt. per acre. In the former the omission of potash, and in the latter that of phosphoric acid, might, it was thought, bring out information as to whether one or the other is essential for corn-growing.

The foregoing alterations being sanctioned by the Committee, they were first introduced in the cropping for 1907 in the case of both wheat and barley.

#### CONTINUOUS GROWING OF WHEAT (*STACKYARD FIELD*), 1907 (31ST SEASON).

The usual course of cultivation, which has frequently been described in detail before, was followed in its main respects. There was a change made, however, in regard to the farmyard manure used on plot 11b; instead of being applied as a top-dressing about the end of January or early in February, the dung was made during the preceding winter (January-February, 1906), and stored, covered with earth, until wanted, and on October 13, 1906, it was ploughed in previous to the sowing of wheat. This had been the plan adopted in the earlier days of the experiments, but had been given up in favour of applying the dung as a top-dressing, the light character of the land leading to the belief that the burying of the dung deeply might render it less available for use and more subject to loss by drainage. The poor crop of 1906, however, induced a return to the earlier practice. The actual weight of farmyard manure put on was 15 cwt. 1 qr. 14 lb. for the  $\frac{1}{2}$  acre plot, or 6 tons 3 cwt. per acre, this being the quantity, as ascertained by analysis, required to supply 100 lb. of ammonia per acre. It

TABLE I.—Continuous Growing of Wheat, 1907  
(31st Season).

(Wheat grown year after year on the same land, the manures being applied every year.)

Stackyard Field—Produce per acre.

Plot	Manures per acre	Head corn		Tall corn	Straw, chaff, &c.	Value per quarter on basis of 8s.	
		No. of bush.	Weight per bushel	Weight		s.	d.
1	Unmanured	8·8	Lb. 61·9	Lb. 40	C. q. lb. 9 3 1	35	6
2a	Sulphate of ammonia (=25 lb. ammonia)	3·5	60·0	8	3 0 10	34	6
2aa	As 2a, with 5 cwt. lime, Jan., 1905	10·5	62·0	28	11 0 16	35	0
2b	As 2a, with 2 tons lime, Dec., 1897	24·2	61·0	80	22 0 10	34	6
2bb	As 2b, with 2 tons lime (repeated), Jan., 1905	15·1	58·0	104	24 3 0	33	0
3a	Nitrate of soda (=50 lb. ammonia)	25·6	57·2	120	33 2 26	33	0
3b	Nitrate of soda (=25 lb. ammonia)	17·3	58·2	68	19 5 10	34	6
4	Mineral manures (superphosphate, 3 cwt.; sulphate of potash, $\frac{1}{2}$ cwt.)	9·2	61·0	24	9 2 18	35	6
5a	Mineral manures and sulphate of ammonia (=25 lb. ammonia)	31·4	62·4	52	27 1 22	35	6
5b	As 5a, with 1 ton lime, Jan., 1905	33·7	61·6	64	31 3 10	35	6
6	Mineral manures and nitrate of soda (=25 lb. ammonia)	23·2	59·8	49	26 0 9	35	0
7	Unmanured	12·2	61·1	24	11 3 2	35	6
8a	Mineral manures and (in alternate years) sulphate of ammonia (=50 lb. ammonia)	17·8 <sup>1</sup>	61·2	48	17 3 18	35	0
8aa	As 8a, with 10 cwt. lime, Jan., 1905	37·0 <sup>1</sup>	62·2	96	32 1 16	35	6
8b	Mineral manures, sulphate of ammonia (=50 lb. ammonia) omitted (in alternate years).	13·3 <sup>2</sup>	64·0	20	13 0 24	35	6
8bb	As 8b, with 10 cwt. lime, Jan., 1905	23·9 <sup>2</sup>	62·7	44	20 2 4	35	6
9a	Mineral manures and (in alternate years) nitrate of soda (=50 lb. ammonia)	26·3 <sup>1</sup>	58·5	82	33 3 10	34	6
9b	Mineral manures, nitrate of soda (=50 lb. ammonia) omitted (in alternate years).	11·1 <sup>2</sup>	61·5	34	13 2 0	34	6
10a	Superphosphate 3 cwt., Nitrate of soda (=25 lb. ammonia)	22·0	61·9	56	27 1 8	35	0
10b	Rape dust (=25 lb. ammonia).	20·7	62·2	54	20 3 22	36	0
11a	Sulphate of potash 1 cwt., nitrate of soda (=25 lb. ammonia).	16·6	60·0	58	21 3 2	35	0
1b	Farmyard manure (=100 lb. ammonia)	19·0	61·4	96	28 1 0	35	0

<sup>1</sup> Applied.<sup>2</sup> Omitted.

TABLE II.—Continuous Growing of Barley, 1907 (31st Season).

(Barley grown year after year on the same land, the manures being applied every year.)  
Stackyard Field—Produce per acre.

Plot	Manures per acre	Head corn		Tail corn	Straw, chaff, &c.	Value per quarter on basis of 30s.	
		No. of bush.	Weight per bush.	Weight		s.	d.
1	Unmanured	20.5	52.0	42	11 1 11	26	6
2a	Sulphate of ammonia (=25 lb. ammonia)						
2aa	As 2a, with 5 cwt. lime, Mar., 1905	13.5	52.0	28	8 0 16	26	0
2b	As 2a, with 2 tons lime, Dec., 1897	25.2	52.7	60	14 3 24	26	0
2bb	As 2b, with 2 tons lime (repeated), Mar., 1905	28.4	51.2	56	16 3 4	26	0
3a	Nitrate of soda(=50 lb.ammonia)	36.4	50.3	74	23 3 22	26	0
3b	Nitrate of soda(=25 lb.ammonia)	31.0	50.6	50	18 1 24	26	0
4	Mineral manures (superphosphate 3 cwt., sulphate of potash $\frac{1}{2}$ cwt.)	16.3	52.7	24	8 3 25	27	6
5a	Mineral manures and sulphate of ammonia(=25 lb.ammonia)	7.1	50.0	4	4 1 7	27	6
5aa	As 5a, with 1 ton lime, Mar., 1905	43.7	55.5	44	25 0 8	29	0
5b	As 5a, with 2 tons lime, Dec., 1897	29.6	53.3	24	16 2 24	28	6
6	Mineral manures and nitrate of soda(=25 lb. ammonia)	35.6	52.3	32	20 3 13	28	6
7	Unmanured	17.5	54.1	48	9 3 25	28	0
8a	Mineral manures and (in alternate years) sulphate of ammonia(=50 lb. ammonia)	13.4 <sup>1</sup>	56.0	36	11 0 17	26	0
8aa	As 8a, with 2 tons lime, Dec., 1897	37.2 <sup>1</sup>	53.9	40	22 3 16	28	0
8b	Mineral manures, sulphate of ammonia(=50 lb. ammonia) omitted (in alternate years).	5.8 <sup>2</sup>	56.0	12	2 2 22	26	0
8bb	As 8b, with 2 tons lime, Dec., 1897	20.3 <sup>2</sup>	54.7	24	9 2 16	27	6
9a	Mineral manures and (in alternate years) nitrate of soda(=50 lb. ammonia)	42.8 <sup>1</sup>	53.6	42	26 0 14	28	6
9b	Mineral manures, nitrate of soda(=50 lb. ammonia) omitted (in alternate years).	28.0 <sup>2</sup>	54.1	18	14 0 27	27	6
10a	Superphosphate 3 cwt., nitrate of soda(=25 lb. ammonia)	22.6	52.7	18	18 2 27	27	6
10b	Rape dust(=25 lb. ammonia)	31.4	54.8	20	19 2 27	27	0
11a	Sulphate of potash 1 cwt., nitrate of soda(=25 lb. ammonia)	35.2	51.6	28	19 2 27	27	6
11b	Farmyard manure(=100 lb ammonia)	45.8	53.0	40	21 3 4	28	0

<sup>1</sup> Applied.

<sup>2</sup> Omitted.

may be of interest to give the following figures relating to the making and storing of the dung :—

Weight of dung as removed from the boxes, Feb. 9, 1906 .	C.	q. lb.
„ „ weighed out for use, Oct. 11, 1906 .	45	1 13
	23	0 0

The seed, "Square Head's Master," was drilled on October 20, 1906, at the rate of 9 pecks per acre, after being dressed with sulphate of copper. Mineral manures (3 cwt. superphosphate and  $\frac{1}{2}$  cwt. sulphate of potash per acre, in accordance with the new plan) were applied on December 10; rape dust (about  $3\frac{1}{4}$  cwt. per acre) on March 7, 1907, and the nitrogenous top-dressings of sulphate of ammonia and nitrate of soda between April 13 and May 7. The heavier dressings (plots 8a, 8aa, 9a) were put on in two lots (April 13 and May 7), the lighter ones on April 29.

During the winter a distinct improvement was made in these experiments by the enclosure with wire fencing of the entire area devoted to the continuous growth of wheat and barley. For some time past it had been noticed that damage was being done to certain plots by hares and rabbits, and as the area comprised plots the largest of which was only  $\frac{1}{4}$  acre in extent, any accidental loss came to be more considerable when multiplied up to give the produce of a full acre. The wiring-in of these small plots thus tends to remove more effectually any sources of error.

The season, it will be well remembered, was one marked by an almost entire absence of warmth, this causing a late and prolonged harvest. It was not until about August 15 that the plots began to ripen, and no cutting was done until August 27. Even then the weather was very "catchy," and the crops could only be got in with difficulty. Finally, all were carted by September 11. The plots to which lime had been applied presented, throughout the year, very striking appearances, and were the subject of much interest to visitors to the farm.

Continuous rain during the month of November delayed threshing beyond the usual time, and it was not until December 3 that this could be undertaken. The corn was subsequently weighed and valued. The results are set out in Table I., page 246.

The general produce was above the average of the last ten years and rather better than in 1906, the unmanured yield (plot 7) being  $12\frac{1}{4}$  bushels per acre. Plots 1 and 4, as explained previously, are influenced by trees and cannot be taken fully into account.

Nitrate of soda alone, at the rate of just over 1 cwt. per acre, gave an increase of 5 bushels (3b) which was further increased by 8 bushels (3a) when the quantity of nitrate was



raised to 2 cwt. per acre. The addition of superphosphate and a little sulphate of potash (6) to the 1 cwt. nitrate of soda gave over 23 bushels, or 11 bushels more than the unmanured produce, while doubling the nitrate (9a) only gave 3 bushels more, the omission of nitrate (9b) as usual taking the yield at once down to the unmanured level.

The results with sulphate of ammonia were, more particularly when taken in conjunction with the action of lime, very striking. With 100 lb. sulphate of ammonia used alone (2a) there was almost total failure, a thick growth of spurry taking the place of the wheat. But the single application (in Jan. 1905) of 5 cwt. lime per acre (2aa) produced 10·5 bushels of wheat per acre, while on plot 2b, which last had lime (2 tons per acre) in December 1897, the yield was 24·2 bushels or double the unmanured crop. The repeating of this dressing of lime in 1905 (2bb) did not do the good expected, as the yield was markedly lower. The flag of the straw was quite browned, and the ear had a dark colour, indicating that the application of lime had been overdone. Possibly this may have been due to the fact that the later application of lime was in the form of ground lime. When used with minerals (5a) 100 lb. sulphate of ammonia continued to yield a good crop, though in places there were signs of failure, and on plot 5b, which had in 1905 1 ton of lime to the acre in addition to the minerals and sulphate of ammonia, the yield was increased by 2·3 bushels and amounted to 33·7 bushels per acre. Where the double quantity (200 lb.) of sulphate of ammonia was used the crop continued to show the decrease marked in recent years, but the application of 10 cwt. of lime to the acre in 1905 on plots 8aa, 8bb, gave an increase of crop, this increase amounting to 19 bushels with 8aa, and 10·6 bushels with 8bb, the results in each case considerably exceeding the produce of the plots 9a and 9b similarly manured with nitrate of soda. Comparing plots 10a and 11a, the presence of phosphates appeared to be more necessary than that of potash, though it is still early to draw conclusions on this point.

Rape dust did not do nearly as well as in 1906, though it was superior to farmyard manure, which, once again, gave a low yield. The farmyard manure plot was weaker in straw and "knocked down" more than any of the others. It would appear not at all unlikely that the soil has, by the repeated dressings, received too much farmyard manure, and that the effect of its continued use is to bring about a too "open" condition of the land. The crop was rather better than in 1906, but this can hardly, as yet, be put down to the ploughing in of the manure in place of applying it as top-dressing.

As regards straw, the nitrate plots gave rather the higher yields, though sulphate of ammonia was not much behind; farmyard manure also gave a good yield, viz., 28 cwt. per acre.

The valuation of the corn was made on the basis of 35s. per quarter of 504 lb. The wheats were described as, on the whole, in exceptionally good condition. The four best samples were good average wheats for the season, possessing both strength and "bloom." The best quality was that grown by rape dust, the unmanured (1 and 7) and minerals only (4) plots coming next, along with sulphate of ammonia and minerals (5a, 5b). Farmyard manure (11b) was but little inferior. Nitrate of soda gave corn generally inferior in quality, and the weight per bushel was lower than in any other case.

#### CONTINUOUS GROWING OF BARLEY (*STACKYARD FIELD*), 1907 (31ST SEASON).

Farmyard manure was carted on to plot 11b on March 15, 1907. The actual weight applied, to give 100 lb. ammonia per acre, was 5 tons 17 cwt. per acre. Chevalier Barley, 9 pecks per acre, was drilled in on March 20, the mineral manures being given at the same time and harrowed in. The top-dressings of sulphate of ammonia and nitrate of soda were applied, as in the case of the wheat, the heavier dressings on May 7 and May 18, and the lighter ones on May 18 only. For a considerable time, and during the almost sunless months of May and June, the barleys were a very moderate lot; the farmyard manure plot (11b), however, was distinctly the best. They all improved greatly as the season went on, and though they could not be cut until September 10, they produced yields very similar to those of the exceptionally good crop of 1906. The results are given in Table II, page 247.

The unmanured produce (average of 1 and 7) was 19.01 bushels per acre, minerals only (4) giving less, viz., 16.3 bushels.

Nitrate of soda (1 cwt. per acre) produced 31 bushels, and 2 cwt. per acre 36.4 bushels, the former, with minerals, yielding 35.6 bushels, while the heavier dressing, with minerals, gave up to 42.8 bushels.

With sulphate of ammonia, more especially in conjunction with lime, the results were particularly interesting. When used alone, sulphate of ammonia gave no crop at all, but the small dressing of 5 cwt. per acre of lime, given in 1905, yielded .35 bushels. The 1897 application of 2 tons per acre of lime produced a crop of 25.2 bushels, and, unlike the result noticed with wheat, the renewal in 1905 of this dressing did further benefit, 28.4 bushels being the yield. Minerals without lime, when sulphate of ammonia was used (5a), continued to be

almost a dead failure, only 7 bushels per acre being given, but this same treatment when it received (in 1905) 1 ton of lime to the acre in addition produced 43.7 bushels (5aa). Plot 5b, which had 2 tons of lime in 1897, only yielded 29.6 bushels. As before, the heavier application of sulphate of ammonia with minerals gave insignificant crops when no lime was used (8a, 8b), but 8aa, with lime (2 tons) last put on in 1897, yielded 37.2 bushels. It is evident from this that, whereas in the case of wheat the application of 2 tons of lime per acre in 1897 seems to be still sufficient and not to require renewal, in the case of barley the lime put on in 1897 seems to be working itself out, and benefit to accrue from its repetition.

Comparing plots 10a and 11a it would seem that potash is more required than phosphates. Rape dust did not do nearly as well as farmyard manure, the latter producing the heaviest crop of the whole series, viz., 45.8 bushels, and showing a marked difference to the wheat crop similarly manured.

The corn was valued on a basis of 30s. per quarter of 448 lb. As a whole the barleys were not good. The best sample (5aa) would alone go for malting. The next few were judged as just passing for low-class malting purposes, and the remainder were only fit for grinding. Nitrate of soda, as usual, gave the lowest weight per bushel (50 lb.), but that of the rape dust sample was 54.8 lb., and of the farmyard manure corn 53 lb. per bushel. Nitrate of soda also produced the largest amount of tail corn. Sulphate of ammonia with mineral manures and lime gave nearly as much straw as did nitrate of soda with minerals.

#### ROTATION EXPERIMENTS (*STACKYARD FIELD*).

The new scheme for these experiments came first into operation in 1904, in which year the root crop on the upper half of the area was fed off by sheep, barley following in 1905 on Rotation IV., the other rotations duly coming into regular order. In this series the root crop was fed off on the several plots by sheep receiving respectively:—Plot 1, decorticated cotton cake; plot 2, maize meal; plots 3 and 4, neither cake nor corn. The cropping for 1907 was:—

Upper Half. Rotation I., Green crop (mustard); Rotation II., Swedes; Rotation III., Barley; Rotation IV., Wheat.

In 1907 the lower half of the area also came under regular rotation experiment. While, on the upper half, the object sought to be attained was to ascertain the difference of manurial value obtained by the consumption of, in the one case, decorticated cotton cake, and in the other, of maize meal, by *sheep feeding off roots on the land*, on the lower half the object was to ascertain what would be the difference of

manurial value between these two foods when they were fed to *bullocks* in feeding-boxes and subsequently carted out to the field as farmyard manure and used for growing a root crop. While the former plan illustrated, so to say, the circumstances that would prevail in the case of the light land farmer, who feeds his roots off on the land with cake or corn, the latter illustrated the case of the farmer who feeds cake or corn to his bullocks in the yards and carts out the dung on to his land.

It was hoped in this way to attack the problem of the unexhausted manurial value of purchased foods according as whether they were fed on the land by sheep, or else given as food to stock at the homestead.

For several years past the lower half of the area had been cropped alike, until, a level condition of fertility having been obtained all over, the new experiment was ready to be begun. This commenced in 1907 with the Root crop on Rotation II., it being manured with farmyard manure made respectively with decorticated cotton cake (plot 5), maize meal (plot 6), and with roots, chaff and litter only, without cake or corn (plots 7 & 8).

#### A.—UPPER HALF (Sheep-feeding).

##### *Rotation I. 1907, Green crop (Mustard).*

This crop followed the barley crop of 1906. The rotation not having previously received lime, 2 tons of Buxton lime to the acre were carted on and spread at the end of February, 1907. Mustard was drilled on July 24, 20 lb. of seed to the acre, and with the exception of plot 2, which was patchy, a nice crop was obtained which was cut and weighed green. The results are given in Table III.

TABLE III.—*Rotation I. Mustard, 1907.*

Stackyard Field.

Plot	Green produce per acre				
		T.	c.	q.	lb.
1	After barley—decorticated cotton cake plot . . . . .	4	10	3	0
2	“ “ maize meal plot . . . . .	3	4	3	0
3	“ “ no cake or corn . . . . .	5	6	3	0
4	“ “ “ “ . . . . .	4	15	3	14

##### *Rotation II. 1907, Swedes.*

On June 3, 1907, 4 cwt. per acre of basic superphosphate and 1 cwt. per acre of sulphate of potash were given to the land, and “Monarch” swede seed was drilled at the rate of 4 lb. per acre. A fair plant was obtained, and though spurry

was very noticeable, there was comparatively little "finger-and-toe." The swedes, however, were much affected by aphid during September. They were pulled and weighed December 16-24, and the weights are recorded in Table IV.

TABLE IV.—*Rotation II. Swedes, 1907.*  
Stackyard Field.

Plot	Produce of roots per acre			
	T.	c.	q.	lb.
1	9	17	2	18
2	9	3	2	25
3	10	3	0	14
4	11	14	3	18

*Rotation III. 1907, Barley.*

The swede crop of 1906 was made up to twelve tons per acre on each plot, and was fed off by eighty sheep which received a little clover-hay chaff in addition to the respective foods assigned to them. The clover-hay chaff came to  $1\frac{1}{2}$  cwt. per acre, the decorticated cotton cake and maize meal to 920 lb. per acre in each case, being about  $\frac{1}{2}$  lb. of cake or corn per head daily. The sheep were on the plots from December 14, 1906, to January 11, 1907. The land was then ploughed and "Chevalier" barley drilled at the rate of 9 pecks per acre, on April 2. The barley came very well indeed and bid fair to be a fine crop. Plot 1 (decorticated cotton cake) was, to appearance, much better than any of the others. Under the influence of a thunderstorm in July this plot "went down" considerably, so that a good deal had to be cut out by hand. The crop was finally harvested by September 10, and was subsequently threshed, the results being given in Table V.

TABLE V.—*Rotation III. Barley, 1907.*  
Stackyard Field—Produce per acre.

Plot		Head corn			Tail corn	Straw, chaff, &c.	Value of corn per quarter on basis of 30s.
		Weight	Bush.	Weight per bushel	Weight		
		C. q. lb.		Lb.	Lb.	C. q. lb.	s. d.
1	Swedes fed off with dec. cotton cake	26 0 4	54.5	53.5	162	40 3 25	26 0
2	Swedes fed off with maize meal	25 0 12	51.0	55.2	73	32 2 2	27 0
3	Swedes fed off without cake or corn	26 2 18	54.6	54.7	94	36 1 0	27 0
4	Swedes fed off without cake or corn	25 0 19	51.2	55.1	58	33 3 12	28 0

It will be seen that the crop was an exceptionally heavy one, the lowest yield (plot 2) being over 50 bushels per acre, and the highest (plots 1 and 3)  $54\frac{1}{2}$  bushels. When such crops as these are yielded it is clear that the land was doing its utmost under the influence of the specially favourable season, and under such circumstances it was not to be expected that the manurial differences would tell. The heavy crop was, in fact, the result of "season" rather than of manuring. The crop of plot 1 (decorticated cotton cake) looked decidedly the heaviest, and it produced most straw, but it "went down" a good deal more than the others, and the yield was not more than from plot 3. The quality of the corn was not good, and none of the samples were really "malting" ones.

*Rotation IV. 1907, Wheat.*

This followed the green crop (mustard) of 1906. Nine pecks per acre of "Square Head's Master" wheat were drilled on October 18, 1906, and a very nice crop was grown which seemed to show little difference between the four plots. It was cut on August 23, and later on was threshed and weighed, the results being given in Table VI.

TABLE VI.—*Rotation IV. Wheat, 1907.*

Stackyard Field—Produce per acre.

Plot		Head corn			Tall corn	Straw, Chaff, &c.	Value of corn per quarter on basis of 35s.					
		Weight	Bush.	Weight per bushel	Weight							
		C	q.	lb.	Lb.	Lb.	C.	q.	lb.	s.	d.	
1	Decorticated cotton cake plot	15	2	5	27·7	62·8	66	26	3	25	36	0
2	Maize meal plot	14	0	13	25·3	62·6	146	25	3	18	36	6
3	No cake or corn	15	1	17	27·3	63·1	50	26	0	16	36	0
4	No cake or corn	14	3	20	26·6	62·8	151	25	2	19	36	0

Here, again, but little difference was shown between the several plots, either in corn or in straw. The yield of plot 1 (decorticated cotton cake) was slightly the highest, but this was probably accidental. The wheats were described as "four very nice samples of wheat, being well grown, strong, and good Millers' wheats."

As the new plan of experiment only began in 1904, and only Rotation IV. has as yet concluded its first rotation-course, it will be well to defer making a general summary of the conclusions come to until the other Rotations (I., II., and III.) have completed their course.

B.—LOWER HALF (Bullock-feeding).

As previously stated, the same crop had been, for several years past, grown over the lower halves of all four rotations, in order to get the land level. In 1905 wheat was the crop, and was followed in 1906 by swedes, which were fed off, on all the plots, with sheep. On Rotation II. the swedes were fed off with decorticated cotton cake, with maize meal, and with clover-chaff only, without cake or corn, according to the new plan of experiment which really began in 1907 with this Rotation (II.). On the other three rotations the swedes were fed off without cake or corn, and the several crops were taken in 1907 as follows:—

Lower half. Rotation I., green crop (mustard); Rotation II., swedes; Rotation III., barley; Rotation IV., wheat.

*Rotation I. 1907, Green Crop (Mustard).*

This crop followed swedes fed off. The rotation, having had lime before, had no more applied now, though the upper half of the rotation area received 2 tons per acre. Mustard was sown as on the upper half (see page 252), and the crop, when weighed green, gave the results set out in Table VII.

TABLE VII.—*Rotation I. Mustard, 1907.*

Stackyard Field.

Plot	Green produce per acre			
	T.	c.	q.	lb.
5	4	17	3	0
6	5	4	3	14
7	4	16	0	0
8	4	13	2	14

*Rotation II. 1907, Swedes.*

This followed, as elsewhere on this half of the rotation area, swedes fed off, but without cake or corn. They were finished by April 5, 1907, and the plots then ploughed. Meanwhile the farmyard manure for the swedes had been made during the winter, in the feeding boxes, by eight bullocks, consuming known weights of decorticated cotton cake, maize meal, roots, &c., and having litter in known quantity supplied to them. To two bullocks decorticated cotton cake was given, along with roots, chaff, &c. (for plot 5), to two others maize meal (for plot 6), while the other four had only roots and chaff (for plots 7 and 8). The principle adopted in the feeding was to keep the amounts of litter, roots, chaff, &c., as nearly alike as possible, so that there might be about the same bulk of manure to apply to the land in each case, but to have the first lot of manure

made with decorticated cotton cake in addition, and the second with maize meal. The actual quantities of cake and maize consumed were :—

		C.	q.	lb.
For plot 5 (half-acre).	Decorticated cotton cake . . . . .	5	0	2
For plot 6 (half-acre).	Maize meal . . . . .	5	0	2

The two bullocks fed on decorticated cotton cake gained 167 lb. in the time of feeding; the two on maize meal 69 lb., whilst two fed without cake or corn lost 46 lb. in the period.

The farmyard manure took 71 days to make; the several lots were then removed and stored in a heap (though divided from one another) and covered with earth until required. The dung was applied May 25-29 to the respective plots at the rate of 4 tons per acre to each. Swede seed ("Monarch") was drilled on June 3 at the rate of 4 lb. per acre, and a nice plant soon showed itself. It was noticeable that spurry, which was abundant on the upper half (previously unlimed) of the rotation area, was entirely absent on this lower (limed) half. Throughout July and August plots 5 and 6 looked decidedly better than 7 and 8, and plot 5 (decorticated cotton cake) was better than plot 6 (maize meal). But in September the swedes were attacked by aphis, and the distinctions between the plots were not greatly marked as time went on. The crop was pulled and weighed December 16-24, and the results are given in Table VIII.

TABLE VIII.—*Rotation II. Swedes, 1907.*

Stackyard Field.

Plot	Produce of roots per acre				
		T.	c.	q.	lb.
5	Decorticated cotton cake dung . . . . .	15	11	3	23
6	Maize meal dung . . . . .	16	10	3	8
7	Dung without cake or corn . . . . .	16	7	0	5
8	do. do. do. do. . . . .	13	15	1	8

It will be seen that plot 6 (maize meal) gave the heaviest crop, and that the average of the two plots 7 and 8 was 15 tons 1 cwt. per acre, not much below that of the decorticated cotton cake plot (5). These weights hardly bore out the appearances which the crops had shown in the earlier periods, but they must be taken and recorded as they existed. The want of uniformity between the two plots 7 and 8 further tells against the satisfactoriness of the experiment.

*Rotation III. 1907, Barley.*

The swedes were fed off by sheep without cake or corn, February 13-28; the land was then ploughed, and "Chevalier"



barley drilled at the rate of 9 pecks per acre on April 2. The crop, as on the upper half, was an excellent one, a few warm days early in September just ripening it off nicely. As this rotation had not yet come under regular experiment, each plot produce was not separately weighed, but the whole produce of plots 5, 6, 7, and 8 was taken together, this giving an average of 49.3 bushels per acre, of 54.5 lb. weight per bushel. Considering especially how very little manure this rotation has received of late years, such a return points clearly to the paramount influence of "season" as against that of manuring. The produce was within 6 bushels of the highest produce of the manured plots on the upper half of this rotation.

*Rotation IV. 1907, Wheat.*

As the swedes of 1906 were being fed off on this rotation by sheep (without cake or corn), it was necessary to sow spring wheat here. On March 7, 9 pecks per acre of "Nursery" wheat were drilled; this came up fairly, but the crop was very late in ripening, and could not be cut until September 20. It was thereafter threshed and weighed as a whole, and yielded an average of 30.9 bushels per acre, of 62.75 lb. weight per bushel.

---

**GREEN-MANURING EXPERIMENT (*LANSOME FIELD*), 1907.**

1907 was the year for the green crops, to be followed by wheat. Winter tares (ten pecks per acre) were drilled on October 22, 1906, on plots 1 and 2, and mineral manures (superphosphate and sulphate of potash) were put on plot 1, November 3. Rape (4 lb. per acre) on plots 3 and 4, and mustard (20 lb. per acre) on plots 5 and 6, were drilled on May 28, 1907, and the mineral manures applied to plots 1, 3, and 5. The first crops were ploughed in, the tares on July 2, the rape and mustard on July 23. All three crops were again sown on August 8, and ploughed in for the second time on October 1, after which wheat was sown over the whole area.

---

**NITRATE OF SODA AND SALT FOR MANGOLDS  
(*BUTT FURLONG*), 1907.**

This experiment, previously carried out on other fields of the farm in the years 1905 and 1906, was repeated in 1907, on Butt Furlong, the soil of which is of distinctly light and sandy character. Indeed, there is in this field a sand pit from which sand is regularly carted. The manurial treatment was just the same as in previous years. About 15 tons of farmyard manure per acre were given to the land on April 15-20, and "Yellow

Globe" mangold seed was drilled just after. The top-dressings of nitrate of soda and salt were given on June 20. For some time the absence of sun and warmth caused the crop to be rather backward, but it improved greatly towards the end of July, though showing, as was universal throughout the country, a large number of "bolted" roots. Ultimately an excellent crop, considering the light character of the soil, was obtained, and this was taken up on November 8-9. The weights are given in Table IX.

TABLE IX.—*Mangold Experiments, 1907 (Butt Furlong).*

Plot	Manures per acre	Produce of roots per acre, 1907			
		T.	c.	q.	lb.
1	Dung only . . . . .	33	7	2	0
2	Dung with nitrate of soda, 1 cwt. . . . .	33	8	2	0
3	Dung with nitrate of soda, 1 cwt. ; salt, 1 cwt. . . . .	33	15	2	0
4	Dung with nitrate of soda, 2 cwt. . . . .	32	16	0	0

In this experiment, as in the rotation barley experiments of this year, it is made abundantly clear that "season" rather than manuring had been the dominant factor. This is shown by the fact that on light land like this the plot without nitrate of soda has given the high produce of 33 tons 7 cwt. per acre. This has been just about the full capability of the land, and consequently the manures have been able to produce but very little more. It is interesting, however, to note that where increases are shown they are in the same direction as were the experiments of the two previous years, an application of 1 cwt. per acre of nitrate of soda along with 1 cwt. of salt per acre giving better results than either 1 cwt. or 2 cwt. per acre of nitrate of soda alone.

#### LUCERNE (*STACKYARD FIELD*), 1907.

These experiments were continued in 1907, no further manurial applications being given. All the sets produced three cuttings, viz., on June 25, August 27, and October 28. These were weighed green, and the results are given in Table X., page 259.

Plots 6 and 7, as in previous years, gave much the highest produce; next in order came the unmanured plot (1), and that manured with sulphate of potash (3), the other applications appearing to have done harm.

TABLE X.—*Lucerne (Stackyard Field).*  
Green produce per acre, 1907 (sixth year).

Plot	Manures per acre, applied 1902, 1903, 1904, 1906.	Green produce per acre <sup>1</sup>			
		T.	c.	q.	lb.
1	No manure . . . . .	11	6	2	0
2	Superphosphate, 4 cwt. ; bone dust, 4 cwt. . . . .	8	9	3	14
3	Sulphate of potash, 4 cwt. . . . .	11	3	3	6
4	Sulphate of ammonia, 2 cwt. . . . .	7	6	3	23
5	Nitrate of soda, 2 cwt. . . . .	10	18	1	18
6	Superphosphate, 4 cwt. ; bone dust, 4 cwt. ; sulphate of potash, 4 cwt. ; sulphate of ammonia, 2 cwt. . . . .	17	9	0	21
7	Superphosphate, 4 cwt. ; bone dust, 4 cwt. ; sulphate of potash, 4 cwt. ; nitrate of soda, 2 cwt. . . . .	19	16	1	14

<sup>1</sup> Three cuttings.

VARIETIES OF LUCERNE (*STACKYARD FIELD*), 1907.

Three cuttings of these new plots—began in 1905—were obtained in 1907. The results are given in Table XI.

TABLE XI.—*Varieties of Lucerne (Stackyard Field).*

Plot	Green produce per acre. <sup>1</sup> 1907 (second year).				
		T.	c.	q.	lb.
A	Provence seed . . . . .	9	11	3	14
B	American seed . . . . .	9	1	1	0
C	Canadian seed . . . . .	12	13	3	0

<sup>1</sup> Three cuttings.

As in 1906, so now, the Canadian variety gave considerably the highest produce. The Provence variety was rather better than the Canadian, this being the reverse of what was obtained in 1906.

GRASS EXPERIMENTS.

1. *Laying-down Pasture, 1906 and 1907 (Great Hill Bottom).*
2. *Improvement of Old Pasture.*
  - (a) *Broad Mead, 1905 and 1907.*
  - (b) *Long Mead, 1906 and 1907.*
1. *Laying-down Pasture (Great Hill Bottom), 1906 and 1907.*

1906.

The earlier laid down (1886 and 1888) portion of the field has for some years past been treated as a whole, the produce of

the individual plots being no longer weighed. Lime (2 tons per acre) had been put (January, 1899) on a strip along the top side of the field, and basic slag (8 cwt. per acre in 1898) on a similar strip along the lower side, but both of these applications failed to make any impression. In December, 1904, the lime dressing was repeated, and also 3 cwt. per acre of superphosphate and 1 cwt. per acre of sulphate of potash given to the upper side, while in December, 1904, the basic slag was repeated on the lower side with the addition of 1 cwt. per acre of sulphate of potash. Though basic slag had, till then, made no improvement, it now, with the sulphate of potash added, began to show a marked change in the pasture; clover began to come, first here and there, and gradually increased over the area, so that in 1906 there was quite a carpet of white clover which spread gradually to the upper end of the field, the improvement in which from the use of lime, superphosphate, and sulphate of potash had not been, hitherto, so decided. It is remarkable that such a change should have been effected, and the result would seem to point to some joint action of the two materials, basic slag and sulphate of potash, inasmuch as each had been tried separately on the grass land of the farm without benefit accruing. At one end of this field were the two plots more recently (1901) laid down with the grasses and deep-rooting plants suggested by Mr. R. H. Elliot, of Clifton Park, Kelso. These were grazed in 1905 with bullocks and sheep, and the stock seemed to eat both the chicory and the burnet very closely. In 1906 the field was put up for hay on July 14, and the produce of these plots was separately weighed, giving results as follows:—

Plot	Produce of Hay per acre, 1906 (fifth year)			
	T.	c.	q.	lb.
4a Elliot's mixture—without rye grass . . .	1	6	2	15
4b Elliot's mixture—with rye grass . . .	1	16	0	18

1907.

Although the field had been hayed in 1906, the grass "came away" so rapidly, owing to the wet spring, that it was impossible to feed it off, and it was once more cut for hay. The only plots actually weighed were the two plots 4a and 4b laid down in 1901 with the mixtures recommended by Mr. R. H. Elliot, of Kelso. These gave, in this the sixth season, the following weights of hay per acre:—

Plot	Produce of hay per acre, 1907 (sixth year)			
	T.	c.	q.	lb.
4a . . . Elliot's mixture—without rye grass . . .	2	4	1	0
4b . . . " " with rye grass . . .	2	0	0	0

The field was subsequently grazed.

## 2. Improvement of Old Pasture.

## (a) Broad Mead.

1905.

The manurial applications were all put on in the winter of 1904 (November 25-30) and the plots were chain-harrowed and rolled in the spring of 1905. By July 8, 1905, the hay crop was ready for cutting, and was carted on July 12. The weights of hay are given in Table XII.

TABLE XII.—Grass Experiments (Broad Mead).

Produce of hay, 1905, and botanical separation.

Plot	Manures per acre in 1901 and 1904	Weight of Hay per acre		Botanical separation		
				Gramineæ	Leguminosæ	Miscellaneous
		T. c.	q. lb.	Per cent.	Per cent.	Per cent.
1	Basic slag, 10 cwt.; nitrate of potash, 1 cwt.	2	6 0 0	94·8	2·0	3·2
2	Superphosphate, 5 cwt.; sulphate of potash, 1 cwt.	2	3 1 0	89·4	5·9	4·7
3	Basic slag, 10 cwt.; sulphate of potash, 1 cwt.	2	3 3 0	89·6	7·1	3·3
4	No manure	1	18 2 0	93·3	3·9	2·8
5	Lime, 2 tons	2	1 1 0	90·5	6·3	3·2
6	Farmyard manure, 12 tons	2	1 3 0	93·9	2·9	3·2

All the applications, it will be observed, gave an increase over the unmanured plot (4). The least increase was from the lime and the farmyard manure. Between basic slag and superphosphate, each used along with sulphate of potash, there was nothing to choose, while the highest return came from basic slag along with nitrate of potash.

Samples of the hay were taken from the different plots and were analysed botanically at Rothamsted, by the kindness of the Director, Mr. A. D. Hall. When this was done previously, in 1903, it was found that on the plots where potash manures had been used, the clovers were markedly increased, the percentage of leguminosæ going up to 27 in the case of plot 2 (superphosphate and sulphate of potash), while with farmyard manure it was so low as 8·5. In 1905, however, there were not these differences, and the leguminosæ went down very considerably, the highest percentage being 7·1 in the case of plot 3 (manured with basic slag and sulphate of potash). Farmyard manure also continued to show a low percentage of clovers. In 1906 the plots were all grazed.

1907.

The manurial applications having last gone on in 1904, basic slag and lime were respectively applied at the end of October, 1906, farmyard manure on December 10, 1906, superphosphate and sulphate of potash on March 12, 1907, and nitrate of potash on April 9, 1907. The grass grew well and was cut for hay June 25 to July 19. Owing to the very uncertain weather, care was taken only to cut as much of the field as could be dealt with at the time, and in this way the whole crop was got in in very good condition. The weights of hay on the experimental plots are given in Table XIII.

TABLE XIII.—*Grass Experiments (Broad Mead).*

Produce of Hay, 1907, and botanical separation.

Plot	Manures per acre in 1901, 1904, and 1906.	Weight of hay per acre	Botanical separation		
			Gramineæ	Leguminosæ	Miscellaneous
		T. c. q. lb.	Per cent.	Per cent.	Per cent.
1	Basic slag, 10 cwt.; nitrate of potash, 1 cwt. . . . .	2 10 2 0	84·0	8·3	7·7
2	Mineral superphosphate, 5 cwt.; sulphate of potash, 1 cwt. . . . .	2 8 1 0	73·6	19·0	7·4
3	Basic slag, 10 cwt.; sulphate of potash, 1 cwt. . . . .	2 12 2 0	83·3	11·2	5·5
4	No manure . . . . .	2 7 0 0	87·1	5·1	7·8
5	Lime, 2 tons . . . . .	2 7 2 0	89·4	6·4	4·2
6	Farmyard manure, 12 tons . . . . .	2 10 2 0	88·1	9·2	2·7

It will be seen that these plots came out very well, the lowest yield being given on the unmanured plot (4). Lime alone (plot 5) did nothing in the way of producing a heavier crop, but the grass was of distinctly finer quality than on plots 4 and 6. Farmyard manure (plot 6), as usual, gave a large crop but of coarse character. The plots manured with basic slag or superphosphate, along with potash salts, were the best, and contained the most clover. The actually highest yield was that of plot 3—basic slag and sulphate of potash.

As regards the botanical composition of the herbage, it will be noticed that plot 2 again assumes the high place it had in 1903 as containing the greatest amount of leguminous plants; plot 3, as before, is next best in this respect, while the unmanured plot shows the lowest percentage of leguminosæ.

*(b) Long Mead.*

1906.

In 1905 the plots were grazed; they were chain-harrowed and rolled in the spring of 1906 and cut for hay on June 30.

The manures were last applied in 1903. The weights of hay are given in Table XIV.

TABLE XIV.—*Grass Experiments (Long Mead).*  
Produce of hay, 1906.

Plot	Manures per acre in 1900 and 1903	Hay per acre		
		T.	c.	q. lb.
1	Lime, 2 tons . . . . .	1	1	2 7
2	No manure . . . . .	1	2	0 21
3	Superphosphate, 5 cwt. ; kainit, 4 cwt. . . . .	1	5	0 0
4	Basic slag, 8 cwt. ; kainit, 4 cwt. . . . .	1	3	0 14

Superphosphate and kainit gave the largest crop, and then basic slag and kainit, but the increases over the unmanured plot were but small. Lime used alone gave no benefit.

1907.

Lime (Buxton lime)—2 tons per acre—was applied to plot 1 on October 29, 1906, and basic slag to plot 4 on November 3, 1906 ; the dressings of superphosphate and sulphate of potash went on to plots 3 and 4 on March 22, 1907. The plots were cut for hay June 21-28, and the weights per acre are given in Table XV.

TABLE XV.—*Grass Experiments (Long Mead).*  
Produce of Hay, 1907.

Plot	Manures per acre in 1900, 1903, and 1906	Weight of hay per acre		
		T.	c.	q. lb.
1	Lime, 2 tons . . . . .	1	16	2 7
2	No manure . . . . .	1	11	1 0
3	Mineral superphosphate, 5 cwt. ; sulphate of potash, 1 cwt. . . . .	2	2	3 7
4	Basic slag, 8 cwt. ; sulphate of potash, 1 cwt. . . . .	1	14	0 7

Here, as in Broad Mead, the unmanured plot (2) gave the lowest yield. Lime (plot 1) effected a slight improvement, especially in the quality of the herbage. Basic slag and sulphate of potash (plot 4) were disappointing in their result, and decidedly the highest yield was given with superphosphate and sulphate of potash (plot 3).

In addition to the foregoing, field experiments on grass land (Broad Mead) were carried out in 1907 with different kinds of sewage sludge, on behalf of the Royal Commission on Sewage Disposal. These form the subject of a separate report to the Board of Agriculture.

RAINFALL AT WOBURN EXPERIMENTAL STATION, 1907.  
(292 ft. above sea level.)

	1907		1907
	In.		In.
January . . . . .	1·04	July . . . . .	1·86
February . . . . .	0·99	August . . . . .	1·84
March . . . . .	0·83	September . . . . .	0·64
April . . . . .	2·20	October . . . . .	3·74
May . . . . .	3·48	November . . . . .	1·84
June . . . . .	1·67	December . . . . .	3·66
		Total . . . . .	23·78

## POT-CULTURE EXPERIMENTS, 1906-7

## (SUMMARY).

IT being the intention to issue shortly, in separate form, a detailed account of the Pot-culture Experiments which have been carried on for some years past, these are not dealt with at any length in the present report. But it is thought well to indicate briefly their present scope and certain points of interest arising out of them.

In the first place, the work in connection with the Hills' Experiments has been continued, the influence of salts of lithium, in particular, being investigated. The presence of a little lithium, in the form of the chloride or the sulphate, as to show '05 of the metal in 100 parts of soil, is found to reduce the yield of wheat to one-quarter of the natural, untreated crop. On the other hand, the presence of sulphate of iron to this same extent increased the produce materially. The detrimental action of lithium salts was found to be largely due to the stunting of root growth.

The chloride and sulphate of manganese have also been shown to have a beneficial effect upon the oat crop, when given in quantities not exceeding 1 cwt. per acre.

Further work has been done on the subject of green manuring, and the results of the Field Experiments in Lansome Field (in which tares ploughed in have always given a subsequent corn crop inferior to that when mustard has been ploughed in) have been explained at the Pot-culture Station by the alteration produced in the physical condition of the soil. When tares are grown the soil is left in a light and very open condition, and there is much more rapid loss of moisture than when mustard is grown; the soil, being left in a less consolidated condition and requiring more moisture to be supplied to it, is, in the case of a light sandy land, such as that of Woburn, in a much less suitable condition for the subsequent growth of a wheat crop after tares have been grown and ploughed in.



The relations of lime and magnesia in soils have been studied, and most interesting results have been obtained, both as regards the quality of the corn (both wheat and barley) produced and the nature of the root growth. It is found generally that as the relative proportions of lime and magnesia in a soil approach nearer and nearer to the ratio 1 : 1 so the wheat grain tends to become more and more glutinous or "hard," in other words to show more "strength." Further, the character of the root growth entirely alters, an increasing proportion of magnesia to lime developing a root of abnormally extensive and fibrous character. These points were well illustrated by specimens sent to the Agricultural Education Exhibition at the Society's Show at Lincoln in June, 1907.

Inquiries have been pursued with regard to the "acid" condition obtained in Stackyard Field soil as the result of the continued application of salts of ammonia to a soil naturally poor in lime. It has been established that the failure of plant on these plots is due, not to an actual deficiency of soil-constituents, but to the presence of a poisonous principle, the nature of which is now being investigated. The removal of this by washing with water and other means has been tried, and the harmful influence of the matter thus removed by washing has been established. Solutions prepared from the acid soil have been allowed to stand and have been noticed to give rise to vegetable growth quite different to that which comes when lime water or magnesium carbonate are added to the solution. The counterpart to this has been observed in the field, in the appearance of the plots themselves according as whether the soil remains acid or has been neutralised by the addition of lime. The general outcome is to lead to the belief that the failure in the field is not directly owing to the removal of lime but to the introduction of some poisonous principle, or to the growth of certain lower forms of vegetation.

Work has been continued in reference to the extermination of weeds, more particularly the wild onion. So far, no practical method of applying any "chemical" to the soil that will directly destroy the wild onion has been found, and attention is now being turned to the alteration of the physical condition of the soil, whereby this may be rendered such as to be unsuited to the ready growth of the weed. Experiments in this direction are now assuming a more hopeful aspect, and the alteration of the texture of the soil and of its capacity for retaining water is being effected by the use of salts which tend to aggregate the finer particles of the soil and in this way to improve the drainage. The growing of a tare crop and the turning in of it are also being tried, the object being, as above,

to alter the physical condition of the soil. This is being done not only at the Pot-culture Station, but also on the field at a farm in the vicinity, where the soil is a heavy clay.

Lastly, in connection with the inquiry of the Commission on Sewage Disposal, a large number of experiments have been carried out at the Pot-culture Station to determine the comparative value of different sewage sludges. These experiments commenced in 1907, and will be continued in 1908.

J. AUGUSTUS VOELCKEL

22 Tudor Street, E.C.

---

## STATISTICS AFFECTING BRITISH AGRICULTURAL INTERESTS.

THE information compiled in the tables printed on pages 288, in continuation of those given in this Journal in previous years, is taken from the official publications of the Board of Agriculture and Fisheries, and other Government Departments as noted below<sup>1</sup>. The data have been brought up to date wherever possible, by the inclusion of the figures for the latest year, and in certain cases changes have been made in consequence of revisions effected by the Board of Agriculture in the returns of the official returns.

Before summarising the general remarks on the distribution of acreage and the number of live stock in the year 1906, furnished in the prefatory report to the first of the four statements into which the single volume of Agricultural Statistics for 1906 is divided, it may be interesting to notice that with the issue of this section of the returns the forty-second statement of Agricultural Statistics is laid before Parliament. First appearing in preliminary and less complete form in 1866, the British Board of Agriculture had in 1867 a complete official picture of the distribution of the cultivated surface of Great Britain, such as had been previously available for Ireland for some considerable time before; and the continuous presentation of these statistics, year by year since, has enabled all engaged either in the practical or the scientific, or the political aspects of agriculture to trace the movements of an epoch of peculiar significance and importance.

In the first of the general tables which follow these returns there will be found a summary for the United Kingdom, in this is included the separately collected data for the Isle of Man, and the Channel Islands, for the details of which

<sup>1</sup> Agricultural Statistics for 1907, Vol. XLII., Part I.; Agricultural Statistics for 1906, Vol. XLI., Parts I., II., and III.; the preliminary statement of the produce of crops and yield per acre for 1906; the Annual Statement of the Board of Trade; and the Trade and Navigation Accounts for December 1906.

which reference must be made to the official volume. This general statement gives the grouping of the crops on the 77,000,000 acres whereon are concentrated the population of 44,000,000 persons who inhabit the Kingdom as a whole. Rather more than one acre per person, or 47,000,000 acres altogether, is accounted for within the so-called cultivated area, whereof in round numbers 27,400,000 acres are classified as permanent grass and 19,600,000 acres are regarded as arable land. Of the latter area not very far short of one-half, or 8,317,000 acres, still carries corn of one description or another. About one-half of the corn area, or 4,219,000 acres, was under oats, and one-fifth part only, or 1,665,000 acres, under wheat in 1907; while the stock of cattle recorded in the United Kingdom now exceeds 11,628,000 head, that of sheep once again exceeds 30,000,000, and the pigs enumerated in these returns are within a little of reaching the 4,000,000 head—a figure which has only been seven times exceeded in the forty years between 1867 and 1907.

#### ACREAGE OF CROPS.

The report which Mr. Rew submits on this occasion to the Secretary of the Board of Agriculture deals, however, in detail only with the 56,200,000 acres forming the land surface of Great Britain, whereof 32,243,447 acres were accounted for as cultivated under crops and grass in 510,954 separate agricultural holdings exceeding one acre of land, while these half million farms employed an additional area of rough grazing land, estimated as 12,742,779 acres. Were the estimated surface under woodlands added to these totals it would be found that 85 per cent. of the measured area is brought under review in these returns. The Department in reviewing the year's figures notes the welcome diminution in the small minority of occupiers whose failure to co-operate in the collection of the yearly statistics slightly retards the date of publication; and it is satisfactory to find that those in default in this matter are now reduced to the very insignificant figure of 2·4 per cent.

The year's changes in Great Britain include a further reduction of 56,000 acres of arable land, but since in 1907 some 53,000 acres less than in 1906 were left in bare fallow there is practically no diminution of arable land actually cropped. Declines in the area under wheat, barley, rye, potatoes, turnips, rape, and hops have been balanced by the parallel extension of oats, beans, peas, mangolds, vetches, lucerne, cabbage, kohlrabi, and other crops.

The area under Wheat in Great Britain in 1907 was 1,625,445 acres, being a decrease of nearly 7½ per cent. on the year; but the shrinkage of 130,000 acres is ascribed rather to the weather

at the time of wheat sowing than to any other cause. The area lost to wheat was greatest in the counties of the eastern and north-eastern division, and least in the northern and north-western; but relatively to the total area under this crop the positions were reversed, and an autumn with a heavy rainfall appears to have affected the wetter districts of the west more than the east. The reduction was general in every county of England and in Wales. In Scotland nine out of the thirty counties showed additions to the small wheat area there grown, while the rest showed decreases.

The area under **Barley** in 1907 was 1,712,094 acres, a decline of 39,144 acres as compared with the preceding year, bringing the acreage below that of 1905, the lowest figure hitherto recorded. The decrease was generally distributed.

**Oats**, with an increase of 79,972 acres, or 2·6 per cent., replaced some of the losses under wheat and barley, and reached an area of 3,122,898 acres in 1907, the greatest relative increase occurring in the west-midland and south-western counties of England, where it amounted to just over 6 per cent.

**Beans** now occupy 309,730 acres, an increase of 20,839 acres, or 7·2 per cent. over 1906. For some years past this crop has been increasing in favour, and this year's return represents an excess of some 80,000 acres over the minimum of 1897. **Peas** recovered some of the area lost last year, and the addition of 12,157 acres, or nearly 8 per cent., brings the total acreage up to 166,136 acres.

**Potatoes** again showed a decline, but not to such a marked degree as in 1906, the deficit this year being 3 per cent.; and the total acreage, 548,920 acres, is the lowest since 1899. **Turnips** and **Swedes** continue to show a decline. The further loss of 27,942 acres, or 1·8 per cent., bringing the total extent of land under this crop in Great Britain down to 1,562,978 acres—the lowest figure on record. **Mangolds**, on the other hand, being increasingly grown in preference to turnips, continue to extend.

The following summary of the area under the potato and root crops is of interest as indicating the relative changes in these crops. Turnips occupy now 465,000 acres less and mangolds occupy 100,000 acres more than at the earlier date:—

Periods	Potatoes	Turnips and Swedes	Mangolds
	Acres	Acres	Acres
Average of 1877-1886	544,000	2,028,000	345,000
" 1887-1896	545,000	1,937,000	347,000
" 1897-1906	560,000	1,670,000	397,000
Year 1907 . . .	549,000	1,563,000	450,000

The acreage under **Cabbage** steadily increases, and the addition of 4,528 acres, or nearly  $6\frac{1}{2}$  per cent., raises the total area to 74,896 acres. During the past 25 years the acreage has been more than doubled. An addition of nearly 3,000 acres, or 16·8 per cent., took place under **Kohl-rabi**, and the area now devoted to this crop reaches about 21,000 acres, or nearly double the average for the period 1881-1885. The chief gains were in **Essex, Kent, Suffolk, and Cambridge.**

The area under **Lucerne** again increased, and the 8,000 acres more than last year represent an augmentation of 14 per cent. The cultivation of **Lucerne** is almost confined to the eastern half of Great Britain, the six counties of **Essex, Kent, Suffolk, Hertford, Cambridge, and Norfolk** accounting for 66 per cent. of the total area.

On the subject of **Small Fruit** the returns for the year 1907 make a new departure, and afford further and more correct information as to the kinds of fruit and their relative importance. Occupiers were this year requested to return small fruit under four, and orchards under five headings, and also to state how much of the land under orchards was also returned as under small fruit. To meet the difficulty of land on which more than one kind of fruit was grown, the following instruction was given in the schedule:—"The average under *mixed* small fruit, containing more of one sort than another, should be entered against the sort to which the larger proportion of the fruit belongs. Where the sorts are equally mixed the entry should be made against 'Other Kinds.'" A similar instruction was given with regard to orchards. The result of this new investigation may be given in the following statement:—

FRUIT AREAS	England	Wales	Scotland	Great Britain
<b>SMALL FRUIT :</b>	Acres	Acres	Acres	Acres
Strawberries . . . . .	23,623	780	3,424	27,827
Raspberries . . . . .	6,480	20	2,378	8,878
Currants and Gooseberries . . . . .	24,179	177	1,234	25,590
Other kinds . . . . .	19,090	236	554	19,880
<b>Total . . . . .</b>	<b>73,372</b>	<b>1,213</b>	<b>7,590</b>	<b>82,175</b>
<b>ORCHARDS :</b>				
Apples . . . . .	168,576	3,115	952	172,643
Pears . . . . .	8,635	93	183	8,911
Cherries . . . . .	11,952	40	35	12,027
Plums . . . . .	14,571	60	270	14,901
Other kinds . . . . .	40,384	363	947	41,694
<b>Total . . . . .</b>	<b>244,118</b>	<b>3,671</b>	<b>2,387</b>	<b>250,176</b>
<b>Acreage of small Fruit in } Orchards . . . . .</b>	<b>22,580</b>	<b>106</b>	<b>806</b>	<b>23,492</b>
<b>Total area under Fruit . . . . .</b>	<b>294,910</b>	<b>4,778</b>	<b>9,171</b>	<b>308,859</b>

As compared with 1906 there is an increase of 1,949 acres under small fruit and of 2,489 acres under orchards. With greater accuracy in the returns both of small fruit and orchards, it may be assumed that the total acreage devoted to fruit-growing on holdings exceeding one acre is fairly represented by the above total of 308,859 acres, of which 82,175 acres carry small fruit alone, and 23,492 acres represent small fruit cultivated in areas returned as orchards.

There was a net increase in the total area under **Clover and Rotation Grasses** of 50,215 acres, or slightly over one per cent. This increase was wholly in the area returned as "for hay," which showed an addition of 58,732 acres. This was confined to England, both Wales and Scotland recording decreases. The area not reserved for hay was increased in both England and Scotland, but in Wales this section was less by nearly 20,000 acres, or over 12 per cent.

The total area under **Permanent Grass** in Great Britain is now 17,277,884 acres, an increase of 33,150 acres. While there was a diminution of 9,364 acres in England, Wales added 34,647 acres, and Scotland 7,867 acres to their totals. Dealing with the two classes "for hay" and "not for hay," separately, the breadth reserved for mowing was extended by nearly 152,000 acres, to which England contributed over 146,000 acres and Wales 6,363 acres, while Scotland showed a slight decrease. The most notable additions occurred in Sussex, Wilts, Kent, and Essex. Only three English counties reported small increases in the area of permanent grass not mown, the largest reductions in the grazing area being in Essex, Kent, and Sussex.

#### LIVE STOCK RETURNS.

Turning to the section of the returns dealing with Live Stock, the enumeration of June, 1907, displays a material increase in the number of sheep, and a still more noteworthy augmentation in the number of swine in Great Britain, accompanied, however, by small reductions in the total stock of cattle, and a still smaller, but in certain aspects significant, decline in the number of horses. The changes which have distinguished the distribution of the cultivated surface between arable land and permanent grass on the one hand, and those occurring annually in the numbers of cattle and sheep on the other, are very succinctly shown, in graphic form, by the curves given in the diagram appearing in Mr. Rew's report. On a thirty years' retrospect cattle are now 20 per cent. more in number and the area of permanent grass is 26 per cent. greater than in 1876-78; while sheep show a decline of 7 per cent. compared with that period, and arable land one of 17 per cent. The yearly fluctuations in either class of live stock are wider and more irregular

vements than are apparent in the steady growth of permanent pasture and the steady decline of the surface under plough.

The census of Horses taken in 1907 shows in the aggregate falling off, compared with 1906, of less than 1 per cent.; but there is little variation in the much larger class of horses used for agricultural purposes, the decrease is significantly confined to the much smaller group of "unbroken horses under 3 year old," where a noticeable check in horse-breeding is indicated by the loss of 10,457, out of the total of 136,941 recorded a year before.

The 6,912,067 Cattle returned in Great Britain are less by 780 than in 1906, resulting from a check in the growth of all classes of cattle other than cows and heifers. The latter group, taken separately, increased by 20,835 head, indicating the steady growth of dairying and especially of the milk-selling business. Every county in the north and north-west of England showed a substantial addition to its dairy stock. In Scotland but two of the Welsh counties there was likewise an increase in cows and heifers. In Scotland several counties on the eastern side showed decreases, but these were outweighed by gains in the south-west.

There is on this occasion a new feature to be noted in the returns of cows and heifers in-milk or in-calf. These were this year divided into two classes, distinguishing those actually in-milk on June 4 from those in-calf but not in-milk at that time. Of the total number, 80 per cent. are given as in-milk at the time of the enumeration, but the proportion varies somewhat widely in different parts of the country. The smallest proportion of cows and heifers actually in-milk is returned from those counties where arable farming still most predominates in England, the proportion falling as low as 70 per cent., in Norfolk, Lincoln, and the East Riding of Yorkshire, against 80 per cent. in the grazing districts. In Wales 84 per cent. of the total, and in the east of Scotland 88 per cent. is reached, though in the west the ratio is not more than 81 per cent.

Among cattle other than cows and heifers there were considerable losses throughout the country. The scarcity of keep and the cost of feeding-stuffs in the early part of the year, together with the high price of beef, are among the causes ascribed to by the collectors as accounting for this depletion.

The number of Sheep in Great Britain was returned as 115,455. This is the largest total since 1901, and 695,095, or 6 per cent., in excess of 1906. The relatively high price of mutton and the maintenance of the price of wool were probably the influential causes of the increase, but a successful lambing season, especially in Wales, Scotland, and the north of

England doubtless contributed. The number of lambs in Great Britain on June 4, 1907, was 384,338 more than in the previous year. Of this increase Scotland gave nearly 200,000, while in the seven northernmost counties of England the total increase of sheep under one year old in 1907 exceeded 100,000. As regards ewes kept for breeding the returns were equally satisfactory. In the remaining class of sheep—those of one year and above, other than breeding ewes—there was an increase of 94,721, but here some very marked local differences occurred. Most of the counties south of the Trent, ranging from Lincoln to Cornwall, showed a depletion, while north of the same boundary practically every county showed a substantial increase.

Pigs numbered 2,636,766 in 1907, or 313,305 more than in the previous year. The growth in numbers was equally marked in both the classes distinguished, viz.: "Sows kept for breeding" and "Other Pigs."

#### PRODUCE RETURNS.

The official estimate of the produce of the year 1907 was made known to the public by the issue of two preliminary statements on November 20 and December 3 last. These figures, which are sufficiently accurate for comparative purposes, are reproduced in the Table III. appended. The customary report from the Board of Agriculture on the general results and local distribution of the yield throughout Great Britain will not be available until after this Journal has gone to press. But from the published figures the following conclusions on the character of the past harvest may be drawn, with the proviso, however, that as a matter of common knowledge the weather of the northern portions of Great Britain in the later autumn frequently prevented the ingathering of the crops estimated to have been grown.

The Wheat crop of the year it will be seen has come to within a fraction of a yield of 34 bushels per acre. This is a higher yield than has been shown since 1898 and is  $2\frac{1}{2}$  bushels beyond the average results of the ten years, 1897-1906. Nevertheless, owing to the reduction of the area under this cereal, already referred to, the total produce of wheat in Great Britain, 6,901,000 quarters, is about  $6\frac{1}{2}$  per cent. below that of 1906. Notwithstanding the good harvest in all but the northern section of the island this is a lower aggregate than was reaped in either of the last two seasons, but compared with the five earlier harvests of this century it exceeds the crops of 1904, 1903, or 1901, and is only slightly below that of 1902.

The Barley crop of 1907 was nearly as much over the decennial mean as wheat, averaging  $35\frac{1}{2}$  bushels per acre in the country as a whole, the English counties showing  $2\frac{1}{4}$  bushels



above the mean figure, and about 1 bushel over the yield of 1906. In Wales and in Scotland the yield was under average but the aggregate crop for Great Britain is estimated at very little under the total of the previous harvest, or 7,545,000 quarters.

**Oats** proved an even more bounteous crop than either of the above with a yield per acre of over 43 bushels, or  $3\frac{1}{4}$  bushels over the ten years' average in Great Britain, and upwards of 5 bushels over that average in England by herself. The aggregate production of this cereal on its now extended acreage is estimated to exceed 16,800,000 quarters—a figure to equal which it will be needful to go back to the crop of 1894.

The past year would appear to have been a good one for the **Bean** and **Pea** crops included in these estimates. The yield in the first case is put at  $34\frac{1}{2}$  bushels per acre, or no less than 5 bushels over the ten years' figure, and although the pea crop was not quite as good as in 1906, and shows a less excess over the mean, it would take a long search over the earlier records to find an equal.

The **Potato** crop of 1907 is estimated to have yielded less than  $5\frac{1}{2}$  tons to the acre, and it was distinctly an under-average one, and below those of the three preceding seasons. It proved, however, better than the poor crops of 1903 and 1900 in Great Britain as a whole. **Turnips** and **Swedes** were less productive than in 1906 both in England and in Scotland; but the average yield was higher than in 1905 or 1903. It is, however, to be remembered that the material shrinkage in the area now occupied by these roots has left us with a turnip crop 3,600,000 tons less than was recorded just ten years ago, with an acreage yield below that of the past season. Against this reduction must of course be set the addition now visible in the total crop of **Mangolds**, where the over-average yield in 1907, here estimated as very little below 20 tons to the acre, represents an aggregate production of little short of 9,000,000 tons.

The **Hop** crop of 1907 was secured on an acreage once again reduced, but the estimated yield of 8.33 cwts. per acre was greatly above the poor crop of 5.26 cwts. secured in 1906; the smaller areas in Hants, Hereford, Sussex, and Worcester showing relatively the larger yields.

The **Hay** harvest of the year was a distinctly over-average one—the estimates for hay cut from clover and rotation grasses being nearly 33 cwt. to the acre, and those for hay from permanent grass  $27\frac{1}{4}$  cwt. as compared with a ten years' average crop of  $29\frac{1}{2}$  cwt. in the first case and under 24 cwt. in the second. As usually happens in the case of hay in all years the experience has necessarily varied considerably in different districts.

TABLE I.—*Acreeage under Crops and Grass; and Number of and Scotland, with totals for Great Britain and for the*

Crops, Grass, and Live Stock.	England		Wales	
	1907	1906	1907	1906
Total Area (excluding water)	Acres 32,381,950		Acres 4,748,394	
Total Acreeage under Crops and Grass <sup>1</sup>	24,585,455	24,600,574	2,791,514	2,793,142
Arable Land . . . . .	10,777,595	10,783,350	769,482	805,757
Permanent Grass . . . . .	13,807,860	13,817,224	2,022,032	1,987,385
Wheat . . . . .	1,537,208	1,661,147	39,930	44,468
Barley or Bere . . . . .	1,411,163	1,439,708	99,622	92,534
Oats . . . . .	1,967,682	1,881,031	203,908	205,110
Rye . . . . .	53,837	56,993	737	1,068
Beans . . . . .	296,186	276,065	1,606	1,308
Peas . . . . .	164,326	152,138	863	860
<b>TOTAL CORN CROPS . . . . .</b>	<b>5,430,402</b>	<b>5,467,082</b>	<b>337,666</b>	<b>345,646</b>
Potatoes . . . . .	381,891	396,516	28,141	29,219
Turnips and Swedes . . . . .	1,058,292	1,082,821	58,496	59,143
Mangold . . . . .	436,193	418,415	11,056	10,621
Cabbage . . . . .	65,282	61,481	622	692
Kohl-Rabi . . . . .	20,572	17,625	82	43
Rape . . . . .	79,913	82,358	4,441	4,497
Vetches or Tares . . . . .	146,067	132,378	832	989
Lucerne . . . . .	63,379	55,405	338	294
Hops . . . . .	44,938	46,722	—	—
Small Fruit <sup>2</sup> . . . . .	73,372	71,978	1,213	1,289
Clover, Sainfoin, and Grass under Rotation . . . . .	2,611,722	2,538,533	319,995	346,566
Other Crops . . . . .	117,914	110,442	1,195	1,034
Bare Fallow . . . . .	248,678	301,594	5,205	5,765
Horses used for Agricultural purposes <sup>3</sup>	No.	No.	No.	No.
Unbroken } One year and above	863,817	865,783	94,444	94,801
Horses } Under one year	234,495	234,779	43,869	44,614
	90,835	99,918	22,185	22,604
<b>TOTAL OF HORSES . . . . .</b>	<b>1,189,147</b>	<b>1,200,480</b>	<b>162,498</b>	<b>162,019</b>
Cows and Heifers { In milk <sup>4</sup>	1,590,010	2,020,340	241,171	283,596
Heifers { In calf but not in milk <sup>4</sup>	442,274		46,836	
Other Cattle:—Two years and above . . . . .	1,043,034	1,067,697	96,096	94,782
.. .. One year and under two . . . . .	992,084	1,031,866	174,024	181,416
.. .. Under one year . . . . .	920,329	940,959	190,757	187,922
<b>TOTAL OF CATTLE . . . . .</b>	<b>4,987,731</b>	<b>5,060,862</b>	<b>738,884</b>	<b>747,715</b>
ewes kept for Breeding . . . . .	5,750,187	5,685,006	1,512,826	1,460,903
Other Sheep: One year and above . . . . .	2,694,392	2,942,698	622,049	620,358
Under one year . . . . .	6,354,349	6,232,225	1,368,495	1,304,834
<b>TOTAL OF SHEEP . . . . .</b>	<b>15,098,958</b>	<b>14,839,927</b>	<b>3,703,372</b>	<b>3,586,095</b>
ewes kept for Breeding . . . . .	321,740	284,950	39,718	34,480
Other Pigs . . . . .	1,935,396	1,698,652	193,278	175,180
<b>TOTAL OF PIGS . . . . .</b>	<b>2,257,136</b>	<b>1,983,602</b>	<b>232,996</b>	<b>209,660</b>

<sup>1</sup> Not including Mountain and Heath Land used for grazing.

<sup>2</sup> Including Mares kept for breeding.

<sup>4</sup> Not separately distinguished until 1907.

*Acres under Crops and Grass ; and Number of Live Stock. 275*

**Live Stock, on June 4, 1907 and 1906, in England, Wales, United Kingdom.**

Scotland		Great Britain		United Kingdom, including Ireland, Isle of Man, and the Channel Islands	
1907	1906	1907	1906	1907	1906
Acres 19,069,662		Acres 56,200,006		Acres 77,096,048	
4,866,478	4,873,039	32,243,447	32,266,755	46,997,546	47,193,339
3,418,486	3,432,914	14,965,563	15,022,021	19,585,826	19,746,600
1,447,992	1,440,125	17,277,884	17,244,734	27,411,720	27,446,739
48,307	50,081	1,625,445	1,755,694	1,665,017	1,801,271
210,309	218,696	1,712,094	1,751,238	1,885,359	1,931,651
951,308	956,785	3,122,898	3,042,926	4,218,541	4,138,407
6,637	6,747	61,211	64,808	70,204	75,422
11,938	11,520	309,730	288,891	311,684	290,980
947	981	166,136	153,979	166,608	154,434
1,220,446	1,244,810	6,997,514	7,057,538	9,317,413	8,382,165
138,888	140,186	548,920	565,921	1,151,632	1,193,662
446,190	448,956	1,562,978	1,590,920	1,846,128	1,877,506
2,604	2,422	450,053	431,458	518,019	499,443
8,612	8,195	74,896	70,368	229,009	226,880
33	46	20,687	17,714		
6,918	6,975	91,272	93,830	156,157	144,949
8,157	8,690	154,056	142,047		
78	45	63,795	55,734	44,938	46,723
—	—	44,938	46,722		
7,580	6,959	82,175	80,228	94,175 <sup>a</sup>	91,510 <sup>a</sup>
1,559,244	1,555,648	4,490,961	4,440,746	6,693,017	6,706,840
2,759	2,814	121,868	114,260	273,621	252,047
7,587	7,178	261,450	314,537	261,717	314,876
No.	No.	No.	No.	No.	No.
155,666	155,921	1,115,927	1,116,505	1,489,064	1,494,242
35,688	35,642	313,952	315,235	415,266	416,267
13,476	14,419	126,490	136,941	184,602	199,515
204,724	206,182	1,556,369	1,568,681	2,088,932	2,110,024
367,032	434,476	2,198,213	2,738,411	4,338,086	4,252,286
71,923		561,033			
249,811	264,275	1,388,941	1,426,754	2,433,928	2,490,805
274,306	281,513	1,440,414	1,494,785	2,449,410	2,505,107
222,380	222,015	1,323,466	1,350,896	2,407,059	2,443,757
1,185,452	1,202,279	6,912,067	7,010,856	11,628,483	11,691,955
3,014,125	2,935,195	10,277,140	10,061,104	11,833,083	11,573,516
1,377,156	1,335,822	5,193,597	5,098,876	5,896,549	5,784,597
2,921,874	2,723,321	10,644,718	10,260,380	12,281,587	11,851,922
7,313,156	6,994,338	26,115,455	25,420,360	30,011,219	29,210,035
18,809	16,892	380,267	336,322	524,589	472,773
127,825	113,307	2,256,499	1,987,139	3,442,235	3,107,967
146,634	130,199	2,636,766	2,323,461	3,966,824	3,580,740

<sup>a</sup> For further details regarding Small Fruit see table on page 269.  
<sup>b</sup> Figures for Ireland include Orchards.

TABLE II.—*Statement of the Acreage of Wheat, Barley, and Oats, and Numbers of Live Stock in each County of Great Britain on June 4, 1907.*

COUNTIES	Corn Crops			Live Stock		
	Wheat	Barley	Oats	Cattle	Sheep	Pigs
	1907	1907	1907	1907	1907	1907
ENGLAND :	Acres	Acres	Acres	No.	No.	No.
Bedford . . . . .	35,339	14,312	22,302	35,999	82,893	27,977
Berks . . . . .	33,458	21,804	35,043	49,187	150,818	23,822
Buckingham . . . . .	29,981	13,916	28,819	79,694	177,040	29,959
Cambridge . . . . .	92,097	52,449	52,367	59,023	164,750	55,706
Chester . . . . .	13,713	1,208	64,953	179,827	99,019	87,391
Cornwall . . . . .	10,718	30,474	65,720	232,347	393,023	103,704
Cumberland . . . . .	1,362	1,570	69,603	156,575	644,067	18,841
Derby . . . . .	13,249	5,177	22,152	141,581	138,687	31,322
Devon . . . . .	41,841	34,610	128,203	296,965	844,230	101,054
Dorset . . . . .	17,818	20,237	33,444	90,333	331,052	56,340
Durham . . . . .	12,071	17,703	31,931	77,327	245,571	13,810
Essex . . . . .	105,630	69,643	73,392	94,699	219,888	83,689
Gloucester . . . . .	39,258	23,421	34,328	130,158	348,362	77,084
Hants . . . . .	52,575	30,036	84,881	93,960	340,761	65,618
Hereford . . . . .	18,443	17,066	26,293	100,719	343,126	29,373
Hertford . . . . .	50,661	21,381	39,316	39,969	90,537	26,942
Huntingdon . . . . .	31,428	20,234	12,095	29,129	82,724	20,187
Kent . . . . .	39,726	32,226	47,170	88,696	918,349	68,319
Lancaster . . . . .	19,225	3,941	77,482	242,873	364,102	81,990
Leicester . . . . .	19,799	9,552	24,022	141,527	301,761	24,598
Lincoln . . . . .	156,453	197,681	133,711	250,574	990,664	116,323
London . . . . .	29	15	70	4,227	3,374	2,038
Middlesex . . . . .	2,160	357	2,459	16,168	13,589	15,133
Monmouth . . . . .	4,130	3,358	8,601	49,892	240,489	17,593
Norfolk . . . . .	112,051	179,556	90,912	134,196	486,107	104,664
Northampton . . . . .	40,032	35,133	28,343	131,737	376,672	31,071
Northumberland . . . . .	5,027	31,050	41,845	120,468	1,122,180	11,790
Notts . . . . .	33,795	30,887	39,767	83,756	163,252	31,131
Oxford . . . . .	32,968	34,941	34,559	65,557	205,699	32,447
Rutland . . . . .	4,541	9,139	4,275	19,629	77,556	2,285
Salop . . . . .	24,480	42,970	46,763	184,315	491,580	77,667
Somerset . . . . .	26,140	19,338	29,355	241,800	471,299	128,266
Stafford . . . . .	19,191	12,845	36,661	165,956	230,169	53,313
Suffolk . . . . .	96,375	127,020	54,429	77,013	339,389	158,101
Surrey . . . . .	15,555	4,926	23,042	43,459	57,519	22,523
Sussex . . . . .	44,310	8,570	59,451	123,437	402,571	41,818
Warwick . . . . .	28,545	10,986	30,213	114,738	255,385	35,227
Westmorland . . . . .	127	442	13,791	70,647	415,360	4,729
Wilts . . . . .	46,810	22,588	54,048	121,124	453,418	61,736
Worcester . . . . .	25,080	6,605	20,792	73,442	160,516	45,536
York, E. Riding . . . . .	64,024	70,294	92,569	92,365	443,912	64,083
"    N. Riding . . . . .	24,574	71,807	69,972	174,165	721,907	57,013
"    W. Riding . . . . .	43,419	49,695	78,538	278,478	705,561	114,923

TABLE II.—continued.—Acreage of Wheat, Barley, and Oats, and Numbers of Live Stock in each County of Great Britain on June 4, 1907.

COUNTIES (continued)	Corn Crops			Live Stock		
	Wheat	Barley	Oats	Cattle	Sheep	Pigs
	1907	1907	1907	1907	1907	1907
<b>WALES:</b>						
	Acres	Acres	Acres	No.	No.	No.
Anglesey . . . . .	184	1,468	19,179	54,156	113,845	15,317
Brecon . . . . .	2,466	3,534	11,098	40,119	534,819	8,104
Cardigan . . . . .	5,537	14,311	26,972	68,933	276,369	21,665
Carmarthen . . . . .	6,813	12,778	24,313	121,129	294,416	37,778
Carnarvon . . . . .	256	5,187	10,721	53,657	288,527	18,433
Denbigh . . . . .	4,856	11,713	24,208	68,809	383,102	28,727
Flint . . . . .	3,401	4,469	10,424	37,631	98,631	19,989
Glamorgan . . . . .	3,465	6,015	10,687	57,871	347,913	17,217
Merioneth . . . . .	622	3,693	8,594	37,054	441,803	7,832
Montgomery . . . . .	8,157	6,758	19,932	72,424	470,425	21,903
Pembroke . . . . .	2,115	17,337	26,413	94,201	150,313	31,822
Radnor . . . . .	2,078	3,359	11,387	32,900	303,010	4,809
<b>SCOTLAND:</b>						
Aberdeen . . . . .	9	25,017	186,051	167,018	245,666	14,243
Argyll . . . . .	—	1,490	17,055	60,324	838,732	4,402
Ayr . . . . .	829	751	43,946	100,421	381,225	13,980
Banff . . . . .	21	9,498	47,908	44,141	65,402	4,001
Berwick . . . . .	1,810	19,088	32,668	16,952	329,438	3,547
Bute . . . . .	1	30	4,686	9,391	40,878	596
Caithness . . . . .	—	846	32,459	20,886	131,682	1,763
Clackmannan . . . . .	240	339	3,294	3,579	15,017	1,164
Dumbarton . . . . .	594	90	6,926	14,271	74,283	1,269
Dumfries . . . . .	81	542	41,808	65,304	577,908	9,362
Elgin, or Moray . . . . .	500	11,896	22,497	22,435	59,560	2,922
Fife . . . . .	10,663	20,445	38,633	45,365	126,436	6,359
Forfar . . . . .	8,556	28,874	47,763	50,754	182,545	7,667
Haddington . . . . .	5,204	15,062	17,271	8,815	132,987	1,864
Inverness . . . . .	71	7,015	29,854	50,106	554,358	2,674
Kincardine . . . . .	626	13,725	26,101	23,835	52,183	3,142
Kinross . . . . .	62	405	6,229	6,450	36,808	646
Kirkcudbright . . . . .	26	3	26,021	51,684	408,196	9,449
Lenark . . . . .	1,885	308	37,768	73,282	256,251	7,026
Linlithgow . . . . .	1,649	2,538	10,023	11,900	25,490	1,415
Midlothian . . . . .	5,305	4,802	21,693	19,207	187,104	9,827
Nairn . . . . .	8	3,219	5,530	5,979	18,951	776
Orkney . . . . .	—	4,313	33,598	28,684	35,713	2,623
Peebles . . . . .	12	336	7,362	7,113	206,224	630
Perth . . . . .	5,396	11,669	65,177	71,604	687,421	8,181
Renfrew . . . . .	1,506	36	10,442	25,719	43,527	1,300
Ross and Cromarty . . . . .	966	11,522	29,762	43,272	279,047	4,608
Roxburgh . . . . .	495	11,181	27,769	18,010	543,677	2,862
Selkirk . . . . .	—	172	4,905	3,457	187,131	384
Shetland . . . . .	—	1,381	7,738	17,499	131,606	1,481
Stirling . . . . .	1,551	2,412	18,369	32,262	124,920	2,199
Sutherland . . . . .	8	906	8,023	11,398	206,024	732
Wigtown . . . . .	233	406	31,969	53,436	126,565	13,640

TABLE III.—Produce of Crops—*Estimated Total Produce and Yield per Acre of the undermentioned Crops in Great Britain in the Year 1907, with Comparisons for 1906, and the Average Yield per Acre of the Ten Years 1897-1906.*

Crops	Estimated total produce		Acreage		Average yield per acre		Average of the ten years	
	1907	1906	1907	1906	1907	1906		
Wheat	Qrs.	Qrs.	Acres	Acres	Bush.	Bush.	Bush.	
	England . . .	6,526,769	6,977,980	1,537,208	1,661,147	33·97	33·61	31·15
	Wales . . .	137,069	158,514	39,921	44,403	27·65	28·56	26·08
	Scotland . . .	236,428	249,977	48,307	50,059	39·15	39·95	38·83
	Great Britain	6,901,166	7,386,471	1,625,436	1,755,609	33·97	33·66	31·22
Barley	England . . .	6,290,730	6,246,063	1,411,163	1,439,708	35·66	34·71	32·88
	Wales . . .	349,622	377,576	90,622	92,834	30·86	32·54	31·27
	Scotland . . .	904,714	945,540	210,309	218,681	34·41	34·59	35·81
	Great Britain	7,545,066	7,569,179	1,712,094	1,751,223	35·26	34·58	33·14
	Oats	England . . .	11,476,709	10,191,564	1,967,671	1,881,031	46·66	43·34
Wales . . .		954,263	977,079	203,908	205,110	37·44	38·11	34·22
Scotland . . .		4,369,313	4,254,462	951,011	956,816	36·76	35·57	36·38
Great Britain		16,800,285	15,423,105	3,122,590	3,042,957	43·04	40·55	39·29
Beans		England . . .	1,270,988	1,190,807	295,129	274,779	34·45	34·67
	Wales . . .	5,835	4,756	1,572	1,300	28·68	29·27	25·84
	Scotland . . .	52,046	50,798	11,430	10,994	36·43	36·96	34·20
	Great Britain	1,328,669	1,246,361	308,131	287,073	34·50	34·73	29·50
	Peas	England . . .	587,788	559,417	159,431	148,034	29·49	30·23
Wales . . .		2,214	2,911	845	858	20·86	27·15	21·41
Scotland . . .		2,089	2,145	600	598	27·86	28·70	26·05
Great Britain		592,091	564,473	160,876	149,490	29·44	30·21	27·10
Potatoes		Tons	Tons			Tons	Tons	Tons
	England . . .	2,098,239	2,439,063	381,891	396,516	5·49	6·15	5·74
	Wales . . .	115,203	143,420	28,141	29,219	4·09	4·91	5·09
	Scotland . . .	764,468	846,228	138,888	140,186	5·50	6·04	5·93
	Great Britain	2,977,910	3,428,711	548,920	565,921	5·43	6·06	5·75
Turnips and Swedes	England . . .	14,651,158	14,104,146	1,058,292	1,082,821	13·84	13·03	12·19
	Wales . . .	881,936	934,997	58,496	59,143	15·08	15·81	14·81
	Scotland . . .	6,526,878	7,588,697	446,202	446,971	14·63	16·90	15·32
	Great Britain	22,059,972	22,627,840	1,562,990	1,590,935	14·11	14·22	13·15
	Mangold	England . . .	8,689,323	8,288,300	436,193	418,415	19·92	19·81
Wales . . .		203,864	203,385	11,056	10,621	18·44	19·16	16·93
Scotland . . .		42,269	46,795	2,792	2,407	15·14	19·44	17·42
Great Britain		8,935,456	8,538,480	450,041	431,443	19·85	19·79	19·17
Hay from Clover, Sainfoin, &c.		England . . .	2,738,779	2,205,545	1,644,622	1,576,114	33·31	27·99
	Wales . . .	252,918	258,246	183,502	190,281	27·57	27·14	24·96
	Scotland . . .	717,934	737,178	422,195	425,192	34·01	34·68	32·34
	Great Britain	3,709,631	3,200,969	2,250,319	2,191,587	32·97	29·21	29·56
	Hay from Permanent Grass	England . . .	5,941,256	4,618,526	4,275,730	4,130,262	27·79	22·36
Wales . . .		561,838	545,942	517,194	510,831	21·73	21·37	19·50
Scotland . . .		216,163	219,096	143,011	142,767	30·23	30·69	29·59
Great Britain		6,719,257	5,383,564	4,935,935	4,783,860	27·23	22·51	23·99

**TABLE IV.—Estimated Total Production of Hops in the Years 1907 and 1906, with the Acreage and Average Yield per Statute Acre, in each County in which Hops were grown.**

COUNTRIES	Estimated total produce		Acreage		Average yield per acre		
	1907	1906	1907	1906	1907	1906	
Kent	Cwt.	Cwt.	Acres	Acres	Cwt.	Cwt.	
	East . . . .	62,035	46,236	8,996	9,863	6'90	4'69
	Mid. . . . .	66,117	50,152	9,647	9,849	6'85	5'09
	Weald . . . .	93,708	70,243	9,526	9,584	9'84	7'33
Total, Kent	221,860	166,631	28,169	29,296	7'88	5'69	
Hants . . . .	17,865	10,263	1,842	1,939	9'70	5'29	
Hereford . . . .	58,268	24,953	6,143	6,481	9'48	3'85	
Salop . . . . .	910	442	129	127	7'05	3'48	
Surrey . . . . .	7,089	3,399	744	777	9'53	4'37	
Sussex . . . . .	39,679	22,070	4,243	4,379	9'35	5'04	
Worcester . . . .	28,216	17,893	3,622	3,672	7'79	4'87	
Other Counties <sup>1</sup> . .	242	37	46	51	5'25	0'72	
Total . . . . .	374,129	245,688	44,938	46,722	8'33	5'26	

**TABLE V. (a)—Number and Size of Agricultural Holdings in each Division of England, in Wales, in Scotland, and in Great Britain in the Year 1907.**

—	1-5 acres	5-50 acres	50-300 acres	Above 300 acres	Total number	Average size, acres
England—						
Division I. . . .	18,883	32,539	22,713	5,019	79,154	78
Do. II. . . . .	16,886	33,066	22,747	3,906	76,605	73
Do. III. . . . .	22,720	41,500	29,783	3,375	97,378	65
Do. IV. . . . .	22,432	58,870	31,684	2,352	118,338	54
Total of England . .	80,921	165,975	109,927	14,652	371,475	66
Wales . . . . .	10,255	31,942	18,042	397	60,636	46
Scotland . . . . .	18,449	34,685	23,123	2,688	78,943	62
Great Britain . . . .	109,625	232,500	151,092	17,737	510,954	63

**TABLE V. (b)—Area of Cultivated Land farmed by Tenants and by Owners respectively, with the Number and Percentage of Holdings "farmed for business" in 1907 in Great Britain.**

—	Acreage occupied by tenants	Acreage occupied by owners	Number of holdings farmed for business	Percentage of total holdings
	Acres	Acres	No.	Per cent.
England . . . . .	21,539,992	3,045,463	347,251	93'5
Wales . . . . .	2,502,489	289,045	58,090	95'8
Scotland . . . . .	4,268,955	597,523	77,210	97'9
Great Britain . . . .	28,311,416	3,932,031	482,551	94'4

<sup>1</sup> Gloucester and Suffolk.

280 *Statistics affecting British Agricultural Interests.*

TABLE VI. (a)—*Average Prices of British Corn per Imperial Quarter in England and Wales, as ascertained under the Corn Returns Act, 1882, in each Week of the Year 1907.*

Week ended	Wheat	Barley	Oats	Week ended	Wheat	Barley	Oats
	<i>s. d.</i>	<i>s. d.</i>	<i>s. d.</i>		<i>s. d.</i>	<i>s. d.</i>	<i>s. d.</i>
January 5 . . . . .	26 0	23 11	17 3	July 6 . . . . .	31 3	24 8	20 11
January 12 . . . . .	26 1	24 2	17 4	July 13 . . . . .	32 0	24 10	20 11
January 19 . . . . .	26 1	24 1	17 5	July 20 . . . . .	32 6	24 6	21 1
January 26 . . . . .	26 2	24 5	17 5	July 27 . . . . .	32 11	27 3	20 8
February 2 . . . . .	26 3	24 4	17 5	August 3 . . . . .	33 2	26 4	21 2
February 9 . . . . .	26 6	24 5	17 7	August 10 . . . . .	33 5	26 6	21 3
February 16 . . . . .	26 7	24 1	17 7	August 17 . . . . .	33 6	25 9	20 4
February 23 . . . . .	26 10	24 2	17 9	August 24 . . . . .	33 7	25 0	19 8
March 2 . . . . .	26 9	24 2	17 9	August 31 . . . . .	33 10	24 6	18 11
March 9 . . . . .	26 8	23 11	17 11	September 7 . . . . .	31 11	24 2	17 7
March 16 . . . . .	26 10	24 2	18 0	September 14 . . . . .	31 4	24 4	17 6
March 23 . . . . .	26 10	24 0	18 1	September 21 . . . . .	31 5	25 0	17 6
March 30 . . . . .	26 8	23 9	18 2	September 28 . . . . .	31 8	25 3	17 8
April 6 . . . . .	26 9	24 3	18 3	October 5 . . . . .	32 6	25 5	17 9
April 13 . . . . .	26 8	23 9	18 6	October 12 . . . . .	33 3	25 9	17 11
April 20 . . . . .	26 8	23 3	18 7	October 19 . . . . .	34 4	26 3	18 0
April 27 . . . . .	26 10	23 3	18 9	October 26 . . . . .	35 0	27 2	18 7
May 4 . . . . .	27 0	23 6	19 3	November 2 . . . . .	36 3	27 7	18 10
May 11 . . . . .	27 6	24 0	19 7	November 9 . . . . .	35 10	27 8	18 10
May 18 . . . . .	28 4	23 10	20 1	November 16 . . . . .	35 1	27 8	18 8
May 25 . . . . .	29 7	24 3	20 5	November 23 . . . . .	34 7	27 5	18 9
June 1 . . . . .	31 4	24 0	20 8	November 30 . . . . .	34 7	27 5	18 7
June 8 . . . . .	32 0	24 7	20 7	December 7 . . . . .	34 7	27 1	18 6
June 15 . . . . .	31 10	24 7	20 11	December 14 . . . . .	34 8	27 0	18 5
June 22 . . . . .	31 4	24 11	20 9	December 21 . . . . .	34 9	27 1	18 3
June 29 . . . . .	31 2	24 6	20 8	December 28 . . . . .	34 6	26 10	18 0
				Average of year . . . . .	30 7	25 1	18 10

TABLE VI. (b)—*Annual Average Prices per Quarter and total Quantities of British Corn sold in the Towns in England and Wales making Returns under the Corn Returns Act, 1882, in the undernoted Years.*

Year	Wheat			Barley			Oats		
	<i>s.</i>	<i>d.</i>	<i>Qrs.</i>	<i>s.</i>	<i>d.</i>	<i>Qrs.</i>	<i>s.</i>	<i>d.</i>	<i>Qrs.</i>
1903	26	9	2,296,723	22	8	2,875,749	17	2	1,049,995
1904	28	4	2,138,142	22	4	3,437,176	16	4	1,316,516
1905	29	8	2,467,551	24	4	3,265,613	17	4	1,073,611
1906	28	3	2,684,101	24	2	3,210,995	18	4	1,011,931
1907	30	7	2,722,847	25	1	3,317,521	18	10	1,374,260

TABLE VI. (c)—*Annual and Septennial Average Prices per Bushel of British Corn in the undernoted Years, with the Value of 100l. of Tithe Rent-charge.*

Year	Annual average price						Septennial average price						Value of tithe rent-charge of 100l.					
	Wheat		Barley		Oats		Wheat		Barley		Oats		Calculated on annual average		Calculated on septennial average			
	<i>s.</i>	<i>d.</i>	<i>s.</i>	<i>d.</i>	<i>s.</i>	<i>d.</i>	<i>s.</i>	<i>d.</i>	<i>s.</i>	<i>d.</i>	<i>s.</i>	<i>d.</i>	<i>£</i>	<i>s.</i>	<i>d.</i>	<i>£</i>	<i>s.</i>	<i>d.</i>
1903	3	4	2	10	2	1½	3	6½	3	1½	2	2½	65	13	10½	69	19	6
1904	3	6½	2	9½	2	0½	3	6	3	1	2	2½	65	1	5	69	12	0½
1905	3	8½	3	0½	2	2	3	5	3	0½	2	2½	69	9	7½	68	12	0½
1906	3	6½	3	0½	2	3½	3	5½	3	0½	2	2½	69	18	7½	68	19	6½
1907	3	9½	3	1½	2	4½	3	6½	3	0½	2	4½	72	19	0½	69	10	6½



TABLE VII.—Average Prices of Fat Cattle per cwt. (Live Weight) at the undermentioned places in England and Scotland, for the years 1900 to 1906 inclusive. Compiled from the Returns received under the Markets and Fairs (Weighing of Cattle) Act, 1891.

Places	1900	1901	1902	1903	1904	1905	1906
<b>ENGLAND—</b>							
Carlisle . . . . .	s. d. 33 2	s. d. 32 2	s. d. 33 2	s. d. 33 6	s. d. 31 11	s. d. 31 6	s. d. 31 6
Leeds . . . . .	33 6	33 0	35 6	34 4	33 4	32 11	33 0
Leicester . . . . .	32 10	33 2	35 2	33 6	32 2	32 9	31 11
Liverpool . . . . .	34 6	33 0	34 10	32 8	32 1	31 3	30 10
London . . . . .	38 0	37 0	39 4	36 4	35 6	35 4	34 10
Newcastle . . . . .	37 10	36 0	38 10	37 0	36 2	34 8	35 4
Shrewsbury . . . . .	33 4	32 10	33 10	33 6	31 9	31 6	31 3
<b>SCOTLAND—</b>							
Aberdeen . . . . .	34 3	32 10	34 9	33 4	32 8	32 6	32 5
Dundee . . . . .	34 7	33 6	34 11	33 3	32 7	32 0	31 11
Edinburgh . . . . .	36 5	35 3	37 4	35 5	34 10	33 10	34 2
Glasgow . . . . .	35 11	35 5	37 10	36 3	35 8	32 6	32 5
Perth . . . . .	37 7	36 9	37 4	35 1	33 3	34 4	34 6
England . . . . .	34 11	33 9	35 5	34 1	33 1	32 8	32 6
Scotland . . . . .	35 3	34 1	36 2	34 6	33 9	33 0	33 0
Great Britain . . . . .	35 2	34 0	35 11	34 4	33 7	32 11	32 11

TABLE VIII.—Average Prices of Wool in the undernoted Years.

Year	ENGLISH				AUSTRALIAN <sup>1</sup>	NEW ZEALAND <sup>2</sup>	SOUTH AFRICAN <sup>3</sup>
	Leicester <sup>1</sup>	Half-breds <sup>1</sup>	Southdown <sup>1</sup>	Lincoln <sup>2</sup>			
	Per lb. d. to d.	Per lb. d. to d.	Per lb. d. to d.	Per lb. d.			
1889	9½ to 10½	10½ to 11	10½ to 12½	11	10½	10½	10½
1890	10 " 10½	10½ " 11½	11 " 13	11	11	10½	10½
1891	9½ " 10	10 " 10½	10½ " 13	9½	9½	9½	9½
1892	8½ " 9	9½ " 10½	10½ " 12½	8¾	8½	9½	9½
1893	8½ " 9½	9½ " 10½	10½ " 12	10½	8½	9½	9½
1894	9 " 10	9½ " 10½	9½ " 12	10½	8½	9	9½
1895	9½ " 10½	9½ " 11	9½ " 11½	12	8	8½	9½
1896	9½ " 11	9½ " 10½	9½ " 11½	11½	8½	8½	7½
1897	8½ " 10	8½ " 9½	8½ " 10½	9½	8	8½	7½
1898	8 " 8½	7½ " 8½	8½ " 9½	8½	8½	8½	7½
1899	7 " 8	7 " 8½	7½ " 11	8½	9½	8	7½
1900	6½ " 7½	6½ " 8½	8 " 12	7½	11	8½	8½
1901	5½ " 6	5½ " 9½	7½ " 9½	6½	8½	6½	7
1902	5 " 5½	5½ " 6½	7½ " 9½	6½	8½	6½	7½
1903	6½ " 6½	7½ " 8	8½ " 11½	7½	9½	7½	7½
1904	8½ " 9½	9½ " 10½	9½ " 11½	10½	10	8½	7½
1905	11½ " 12	11½ " 12½	11½ " 13½	12½	10½	9½	7½
1906	12½ " 13	13½ " 14½	14½ " 15½	14½	11	11½	8½

<sup>1</sup> Computed from the prices given weekly in *The Economist* newspaper.  
<sup>2</sup> Prices extracted from "The Yorkshire Daily Observer Wool Tables."  
<sup>3</sup> Calculated from the Trade and Navigation Accounts.

TABLE IX. (a)—*Quantities and Values of Corn Imported into the United Kingdom in the undernoted Years.*

Description	Quantities			Values		
	1905	1906	1907	1905	1906	1907
	Cwt.	Cwt.	Cwt.	£	£	£
Wheat . . . . .	97,622,752	92,967,200	97,168,800	35,279,931	32,876,185	37,336,639
Wheat meal and flour . . . . .	11,954,763	14,180,300	13,297,367	6,044,845	6,817,213	6,694,532
Barley . . . . .	21,426,900	19,934,500	19,628,620	6,017,350	5,877,587	6,565,006
Oats . . . . .	17,095,463	15,286,500	10,488,290	4,713,265	4,532,160	3,384,577
Peas . . . . .	2,015,876	1,453,420	1,245,690	725,104	614,649	602,648
Beans . . . . .	1,226,050	634,280	799,569	414,227	231,758	290,663
Maize . . . . .	42,101,210	46,685,200	53,378,950	11,034,748	11,972,664	14,604,159
Oatmeal and groats . . . . .	633,199	661,809	638,702	463,293	495,980	479,352
Maize meal . . . . .	459,188	616,200	658,656	144,829	195,302	213,581
Other kinds of corn and meal . . . . .	1,712,434	1,746,352	1,589,158	581,457	609,553	644,789

TABLE IX. (b)—*Countries from which Wheat, and Wheat Meal or Flour, were Imported into the United Kingdom in the undernoted Years.*

Countries	1903	1904	1905	1906	1907
WHEAT from—	Cwt.	Cwt.	Cwt.	Cwt.	Cwt.
Russia . . . . .	17,176,300	23,529,500	24,703,200	15,017,500	10,900,300
Germany . . . . .	310,176	251,000	300,000	71,800	19,900
Turkey . . . . .	433,004	431,200	244,800	242,100	522,600
Roumania . . . . .	3,140,727	1,491,800	2,082,200	3,780,900	3,256,800
United States . . . . .	24,197,895	7,051,600	6,634,700	22,490,900	20,696,900
Chile . . . . .	238,644	915,400	162,800	800	85,100
Argentina . . . . .	14,120,454	21,440,400	23,236,400	19,176,500	21,900,600
Brit. E. Indies . . . . .	17,057,857	25,493,000	22,807,422	12,636,200	18,269,600
Australasia . . . . .	230	10,630,700	10,404,600	7,864,500	8,327,500
Canada . . . . .	10,802,127	6,195,300	6,522,030	11,309,700	12,469,700
Other countries . . . . .	653,616	352,600	524,600	376,300	719,800
<b>TOTAL WHEAT.</b>	<b>88,131,030</b>	<b>97,782,500</b>	<b>97,622,752</b>	<b>92,967,200</b>	<b>97,168,800</b>
WHEAT MEAL AND FLOUR from—	Cwt.	Cwt.	Cwt.	Cwt.	Cwt.
Germany . . . . .	37,020	264,740	479,300	190,600	321,030
France . . . . .	577,498	1,486,920	1,034,503	560,500	661,700
Austria-Hungary . . . . .	817,879	733,294	622,885	628,230	428,553
United States . . . . .	16,223,639	8,252,602	5,685,418	9,809,270	9,324,564
Canada . . . . .	2,637,617	2,045,767	1,330,100	1,810,500	1,837,920
Other countries . . . . .	307,795	1,939,570	2,802,557	1,191,200	723,600
<b>TOTAL WHEAT MEAL AND FLOUR</b>	<b>20,601,448</b>	<b>14,722,893</b>	<b>11,954,763</b>	<b>14,190,300</b>	<b>13,297,357</b>

**TABLE X.—Number and Value of Cattle, Sheep, and Swine Imported into and Exported from the United Kingdom in the undernoted Years.**

(a) IMPORTS.						
	Number			Value		
	1905	1906	1907	1905	1906	1907
				£	£	£
<b>CATTLE</b> from—						
Channel Islands	1,515	1,639	1,801	25,517	29,330	30,905
Canada	148,718	160,689	125,753	2,491,150	2,765,440	2,150,469
United States	414,906	398,887	344,461	7,149,139	6,937,410	5,923,735
<b>TOTAL</b>	<b>565,139</b>	<b>561,215</b>	<b>472,015</b>	<b>9,665,806</b>	<b>9,732,180</b>	<b>8,105,109</b>
<b>SHEEP &amp; LAMBS</b>						
from—Canada	28,240	14,296	14,485	45,580	22,228	26,216
United States	150,095	84,184	88,584	226,628	127,401	139,150
Iceland and Greenland	4,749	4,879	2,532	6,545	7,318	3,165
<b>TOTAL</b>	<b>183,084</b>	<b>103,359</b>	<b>105,601</b>	<b>278,753</b>	<b>156,947</b>	<b>168,531</b>
<b>PIGS</b> from—						
Canada	150	—	—	300	—	—
<b>TOTAL VALUE</b>	<b>—</b>	<b>—</b>	<b>—</b>	<b>9,944,859</b>	<b>9,889,127</b>	<b>8,273,640</b>
(b) EXPORTS.						
				£	£	£
<b>CATTLE</b> to—						
Channel Islands	1,384	1,621	— <sup>1</sup>	19,459	22,931	— <sup>1</sup>
Canada	72	161	—	2,021	6,044	—
United States	149	521	—	4,062	15,454	—
Argentina	1,388	2,329	—	109,734	215,231	—
Other countries	945	984	—	55,130	67,675	—
<b>TOTAL</b>	<b>3,938</b>	<b>5,616</b>	<b>5,066</b>	<b>190,406</b>	<b>327,335</b>	<b>227,316</b>
<b>SHEEP &amp; LAMBS</b>						
to—Australasia	267	583	— <sup>1</sup>	4,192	7,626	— <sup>1</sup>
Canada	343	1,135	—	1,504	7,253	—
United States	514	652	—	2,693	3,607	—
Argentina	5,208	7,999	—	97,385	159,640	—
Germany	659	735	—	6,191	6,993	—
Other countries	1,387	—	—	21,448	—	—
<b>TOTAL</b>	<b>8,378</b>	<b>12,716</b>	<b>9,973</b>	<b>133,413</b>	<b>204,061</b>	<b>134,620</b>
<b>PIGS</b> to—						
British possessions	195	151	— <sup>1</sup>	1,488	1,642	— <sup>1</sup>
Foreign countries	736	2,070	—	6,536	18,650	—
<b>TOTAL</b>	<b>931</b>	<b>2,221</b>	<b>1,357</b>	<b>8,024</b>	<b>20,292</b>	<b>11,059</b>
<b>TOTAL VALUE</b>	<b>—</b>	<b>—</b>	<b>—</b>	<b>331,843</b>	<b>551,688</b>	<b>372,995</b>

<sup>1</sup> The details as to countries have not yet been officially issued.

TABLE XI.—*Number and Value of Horses Imported into and Exported from the United Kingdom in the undernoted Years.*

## (a) IMPORTS.

Countries	Number			Value		
	1905	1906	1907	1905	1906	1907
<b>HORSES from—</b>				£	£	£
Canada . . .	296	225	166	15,055	10,822	7,090
Denmark . . .	1,181	80	— <sup>1</sup>	32,608	2,825	— <sup>1</sup>
France . . .	1,233	1,493	— <sup>1</sup>	93,167	261,078	— <sup>1</sup>
Germany . . .	2,756	172	— <sup>1</sup>	37,285	3,294	— <sup>1</sup>
Holland . . .	1,445	1,079	— <sup>1</sup>	57,107	108,096	— <sup>1</sup>
Russia . . .	2,535	11,665	— <sup>1</sup>	27,599	123,886	— <sup>1</sup>
United States . . .	1,135	818	786	48,266	36,795	40,575
Other countries	3,130	2,316	14,970	42,943	48,736	381,884
<b>TOTAL . . .</b>	<b>13,711</b>	<b>17,848</b>	<b>15,922</b>	<b>354,030</b>	<b>535,532</b>	<b>429,549</b>

## (b) EXPORTS.

<b>HORSES to—</b>				£	£	£
Canada . . .	707	1,625	— <sup>1</sup>	54,716	97,208	— <sup>1</sup>
United States . . .	878	971	— <sup>1</sup>	58,222	91,184	— <sup>1</sup>
Belgium . . .	23,986	30,892	30,134	235,347	305,424	304,906
France . . .	3,050	2,524	2,233	154,431	164,602	100,315
Germany . . .	1,337	1,596	— <sup>1</sup>	51,745	81,783	— <sup>1</sup>
Holland . . .	16,359	20,820	20,964	204,673	188,203	267,545
Russia . . .	5	52	— <sup>1</sup>	400	4,181	— <sup>1</sup>
Other countries	1,386	1,934	7,052	116,113	272,717	455,816
<b>TOTAL . . .</b>	<b>47,708</b>	<b>60,414</b>	<b>60,383</b>	<b>875,647</b>	<b>1,205,302</b>	<b>1,128,582</b>

<sup>1</sup> Included in "other countries" in official returns available.

NOTE.—In addition to the exports shown in this table there were sent abroad the following numbers of horses of foreign or colonial origin:—1,091, 1,250, and 1,400 in the three years named.

TABLE XII.—Quantities and Values of Fruit, Vegetables, and Hops Imported into the United Kingdom in the Years 1905, 1906, and 1907.

	Quantity			Value		
	1905	1906	1907	1905	1906	1907
	Cwt.	Cwt.	Cwt.	£	£	£
Apples . . .	3,494,660	2,808,732	3,526,213	2,065,193	1,753,577	2,231,327
Strawberries. . .	29,399	52,251	44,178	40,120	64,777	54,186
Cherries . . .	186,682	191,106	165,412	253,042	245,906	199,489
Plums . . .	480,211	891,113	325,761	524,673	758,720	345,720
Pears . . .	417,919	576,573	500,142	407,817	572,274	478,611
Grapes . . .	700,050	690,371	798,377	761,632	667,969	769,301
Oranges . . .	5,068,526	5,230,911	6,120,185	1,949,496	2,183,411	2,454,569
Lemons . . .	837,028	849,935	882,233	419,049	440,406	421,599
Unenum'd (raw) . . .	502,097	504,345	538,465	354,143	388,598	339,462
	Bushels	Bushels	Bushels			
Onions . . .	7,587,025	8,310,534	8,645,048	1,094,802	953,615	1,036,231
	Cwt.	Cwt.	Cwt.			
Potatoes . . .	3,664,290	3,819,787	8,249,463	1,404,607	1,332,027	2,371,617
Tomatoes . . .	1,187,193	1,124,700	1,135,594	970,579	953,475	1,020,795
Vegetables, raw, unenumerated . . .	—	—	—	419,752	404,928	365,230
Hops . . .	108,953	232,619	202,324	456,280	852,476	763,881

TABLE XIII.—Horses, Cattle, Sheep, and Pigs Imported into Great Britain from Ireland and Exported from Great Britain to Ireland.

Live Stock	Imports from Ireland				Exports to Ireland			
	1904	1905	1906	1907	1904	1905	1906	1907
<b>HORSES :</b>	No.	No.	No.	No.	No.	No.	No.	No.
Stallions . . .	235	202	257	197	182	179	338	273
Mares . . .	12,909	14,192	15,316	15,163	3,248	2,832	2,598	1,997
Geldings . . .	14,356	16,329	18,243	17,890	3,284	2,996	2,162	1,712
<b>TOTAL . . .</b>	<b>27,500</b>	<b>30,723</b>	<b>33,816</b>	<b>33,250</b>	<b>6,714</b>	<b>6,007</b>	<b>5,098</b>	<b>3,982</b>
<b>ATTLÉ :</b>								
Fat . . .	232,186	224,943	240,566	292,104	—	—	—	7
Store . . .	470,361	455,667	473,425	492,936	608	584	429	647
Others . . .	6,896	6,205	5,897	6,071	—	—	—	4
Calves . . .	62,920	62,316	55,486	50,858	31	47	30	60
<b>TOTAL . . .</b>	<b>772,363</b>	<b>749,131</b>	<b>775,374</b>	<b>841,969</b>	<b>639</b>	<b>631</b>	<b>459</b>	<b>718</b>
<b>SHEEP :</b>								
Sheep . . .	372,159	350,953	293,174	317,039	29,681	34,101	45,837	46,606
Lambs . . .	367,107	349,673	364,239	343,376	8,608	8,722	8,432	16,096
<b>TOTAL . . .</b>	<b>739,266</b>	<b>700,626</b>	<b>657,413</b>	<b>660,415</b>	<b>38,289</b>	<b>42,823</b>	<b>54,269</b>	<b>62,702</b>
<b>PIGS :</b>								
Fat . . .	478,922	362,791	409,510	448,578	5	9	3	7
Store . . .	26,158	1,032	19,920	33,329	19	14	68	21
<b>TOTAL . . .</b>	<b>505,080</b>	<b>363,823</b>	<b>429,430</b>	<b>481,907</b>	<b>24</b>	<b>23</b>	<b>71</b>	<b>28</b>

TABLE XIV.—*Quantities and Values of Dead Meat Imported into the United Kingdom in the undernoted Years.*

DEAD MEAT		1905		1906		1907		
		Quantities	Values	Quantities	Values	Quantities	Values	
BACON :		Cwt.	£	Cwt.	£	Cwt.	£	
	From United States . . .	2,755,233	5,828,392	2,775,919	6,859,061	2,280,644	6,042,579	
	" Denmark . . .	1,471,687	3,978,317	1,463,880	4,324,055	1,806,934	5,385,275	
	" Canada . . .	1,191,390	2,751,714	1,190,524	3,135,391	1,192,401	3,171,562	
	" Other countries . . .	80,650	216,432	112,299	325,608	85,626	239,750	
	Total . . .	5,498,960	12,774,855	5,542,622	14,644,115	5,365,005	14,839,291	
BEEF :								
	Salted . . .	From United States . . .	135,277	191,115	146,163	197,238	115,400	168,700
		" Other countries . . .	7,529	11,192	15,200	20,709	22,937	31,522
		Total . . .	142,806	202,307	161,363	217,947	138,346	200,222
	Fresh . . .	From United States . . .	2,232,206	4,834,611	2,426,644	5,235,663	2,417,604	5,176,393
" Argentina . . .		2,580,152	3,751,780	2,795,913	4,136,819	2,691,554	4,306,273	
" Australasia . . .		164,363	239,740	273,328	370,505	517,329	750,338	
" Other countries . . .		60,800	105,462	27,924	42,630	108,516	167,998	
	Total . . .	5,037,521	8,931,503	5,523,809	9,785,607	5,735,003	10,397,102	
HAMBS :								
	From United States . . .	1,022,855	2,409,993	1,045,718	2,808,823	832,042	2,385,400	
	" Canada . . .	292,173	898,463	254,495	674,469	296,949	845,021	
	" Other countries . . .	3,274	9,916	2,539	8,302	3,658	11,762	
		Total . . .	1,318,302	3,118,372	1,302,752	3,491,594	1,132,649	3,242,183
MEAT (unenumerated) :								
	Salted or fresh . . .	From Holland . . .	253,103	573,338	222,280	502,027	211,971	479,46
		" United States . . .	166,088	255,921	189,328	282,128	178,797	256,200
		" Other countries . . .	250,953	396,433	240,755	361,309	272,186	394,59
		Total . . .	670,144	1,225,692	652,363	1,145,464	662,954	1,129,26
Preserved, otherwise than by salting . . .	Beef . . .	598,030	1,789,399	296,301	1,103,695	160,388	894,44	
	Mutton . . .	30,111	77,112	48,443	125,954	39,220	85,54	
	Other sorts . . .	204,888	780,684	142,680	593,022	116,899	554,88	
	Total . . .	833,029	2,647,195	487,424	1,822,671	316,507	1,534,9	
MUTTON :								
	Fresh . . .	From Australasia . . .	2,030,394	4,152,761	2,365,058	4,566,254	2,863,304	5,641,6
		" Argentina . . .	1,462,537	2,458,915	1,433,097	2,440,696	1,402,302	2,360,5
		" Holland . . .	235,172	539,672	234,926	556,100	221,223	528,4
		" Other countries . . .	82,966	185,142	49,675	102,585	105,313	181,2
	Total . . .	3,811,069	7,336,490	4,082,756	7,645,935	4,592,142	8,711,9	
PORK :								
	Salted (not hams) . . .	From United States . . .	72,528	111,082	67,775	116,480	55,919	100,7
		" Other countries . . .	133,437	141,524	138,281	150,320	198,718	227,6
		Total . . .	205,965	252,606	206,056	266,800	254,637	328,3
	Fresh . . .	From Holland . . .	306,379	713,523	318,296	739,588	429,324	1,004,8
" Belgium . . .		39,344	97,430	13,225	32,744	18,340	45,0	
" United States . . .		135,233	292,390	120,734	268,804	86,612	204,2	
" Other countries . . .		24,677	59,018	39,866	89,814	33,056	84,0	
	Total . . .	505,633	1,162,370	492,121	1,130,950	567,332	1,338,3	
RABBITS :								
	From Australasia . . .	562,086	568,431	717,981	761,172	613,613	636,6	
	" Belgium . . .	69,624	199,777	66,811	185,207	62,885	176,7	
	" Other countries . . .	23,468	67,721	18,764	54,407	19,925	49,3	
		Total . . .	655,178	835,929	803,556	1,000,786	696,423	862,7
<b>TOTAL OF DEAD MEAT . . .</b>		<b>18,679,507</b>	<b>38,487,409</b>	<b>19,254,822</b>	<b>41,151,800</b>	<b>19,458,098</b>	<b>42,685,1</b>	

**TABLE XV.—Imports of Butter, Margarine, Cheese, Milk, Poultry, and Eggs into the United Kingdom in the undernoted Years, showing the Countries from which sent.**

	Quantities			Values		
	1905	1906	1907	1905	1906	1907
<b>BUTTER :</b>						
From Russia . . . . .	Cwt. 461,140	Cwt. 606,549	Cwt. 657,649	£ 2,246,503	£ 2,918,124	£ 3,086,821
" Sweden . . . . .	188,209	182,803	226,740	1,021,603	1,036,638	1,269,820
" Denmark . . . . .	1,630,363	1,675,761	1,818,811	8,919,766	9,636,862	10,192,587
" Germany . . . . .	5,372	10,701	7,297	27,169	56,559	34,832
" Holland . . . . .	209,897	195,366	168,496	1,047,690	993,396	856,288
" France . . . . .	348,442	319,401	281,306	1,860,545	1,775,601	1,651,137
" New South Wales . . . . .	168,531	180,655	201,568	848,022	957,702	1,009,266
" Queensland . . . . .	54,188	77,982	97,685	269,077	404,980	473,104
" Victoria . . . . .	227,574	287,190	288,670	1,144,141	1,568,057	1,470,280
" New Zealand . . . . .	300,418	311,672	313,863	1,467,628	1,626,997	1,599,226
" Canada . . . . .	292,117	190,968	34,753	1,428,494	976,008	175,537
" United States . . . . .	84,874	157,312	1,063	401,916	748,197	5,450
" Other countries . . . . .	176,741	140,898	118,534	904,068	761,075	628,112
<b>Total . . . . .</b>	<b>4,147,866</b>	<b>4,337,258</b>	<b>4,216,435</b>	<b>21,586,622</b>	<b>23,460,196</b>	<b>22,452,460</b>
<b>MARGARINE :</b>						
From Norway . . . . .	6,731	5,291	6,099	16,153	12,504	14,385
" Holland . . . . .	1,051,630	1,058,618	836,658	2,617,743	2,601,344	2,085,462
" France . . . . .	27,324	29,422	26,505	95,259	102,500	92,684
" Other countries . . . . .	2,574	8,626	15,806	6,581	17,447	31,114
<b>Total . . . . .</b>	<b>1,088,259</b>	<b>1,101,957</b>	<b>885,068</b>	<b>2,735,736</b>	<b>2,733,795</b>	<b>2,223,645</b>
<b>CHEESE :</b>						
From Holland . . . . .	214,033	229,341	241,553	498,994	545,947	583,582
" France . . . . .	48,884	43,244	47,036	158,224	140,702	152,187
" Australia . . . . .	—	—	3,515	—	—	10,833
" New Zealand . . . . .	78,626	126,216	192,301	203,344	370,666	586,675
" Canada . . . . .	1,858,767	1,925,835	1,698,847	4,804,172	5,634,288	4,989,399
" United States . . . . .	175,256	233,445	114,300	445,003	656,705	337,302
" Other countries . . . . .	67,116	80,713	74,683	230,074	259,333	245,534
<b>Total . . . . .</b>	<b>2,442,682</b>	<b>2,638,794</b>	<b>2,372,235</b>	<b>6,339,811</b>	<b>7,607,641</b>	<b>6,905,512</b>
<b>CONDENSED MILK :</b>	893,634	907,983	911,876	1,584,363	1,563,677	1,599,637
<b>MILK AND CREAM : other than Condensed)</b>	8,542	12,279	11,362	23,819	24,040	22,408
<b>POULTRY (and game) :</b>						
From Russia . . . . .	—	—	—	291,917	206,260	318,105
" Belgium . . . . .	—	—	—	199,115	198,421	183,113
" France . . . . .	—	—	—	228,001	204,402	206,879
" Other countries . . . . .	—	—	—	280,447	376,374	349,836
<b>Total . . . . .</b>	—	—	—	<b>999,480</b>	<b>985,457</b>	<b>1,057,933</b>
<b>EGGS :</b>						
From Russia . . . . .	Great Hundreds 7,622,393	Great Hundreds 7,132,928	Great Hundreds 7,178,941	2,426,029	2,344,256	2,392,044
" Denmark . . . . .	3,858,135	3,823,942	3,800,366	1,634,288	1,701,291	1,774,318
" Germany . . . . .	2,175,721	2,644,242	2,821,124	764,966	957,905	1,030,190
" Belgium . . . . .	2,152,953	2,444,746	2,133,612	830,598	992,103	891,460
" France . . . . .	1,565,572	1,491,219	1,232,107	660,369	623,104	541,088
" Canada . . . . .	260,140	231,719	115,872	114,557	106,393	53,084
" Other countries . . . . .	1,179,379	1,105,263	1,285,869	381,629	373,070	452,348
<b>Total . . . . .</b>	<b>18,814,293</b>	<b>18,874,059</b>	<b>18,567,891</b>	<b>6,812,436</b>	<b>7,098,122</b>	<b>7,134,532</b>

TABLE XVI.—*Quantities and Values of Wool, Wood, Seeds, Manures, &c., Imported into the United Kingdom in the Years 1905, 1906, and 1907.*

	Quantities			Values		
	1905	1906	1907	1905	1906	1907
<b>WOOL: Sheep and Lambs'—</b>	Lb.	Lb.	Lb.	£	£	£
Total Imports.	615,708,827	639,342,939	759,236,745	23,821,825	27,146,133	32,692,967
Re-exported	277,102,616	269,135,040	312,673,305	10,933,483	11,197,764	13,350,821
Excess of Imports.	238,606,211	370,207,899	446,563,440	12,888,342	15,948,369	19,342,146
<b>WOOD AND TIMBER:</b>	Loads	Loads	Loads			
Hewn	2,856,551	3,246,731	3,512,984	5,473,805	6,411,243	6,990,764
Sawn or split, planed or dressed	5,986,526	6,692,260	5,985,423	15,255,330	18,534,958	17,146,790
Staves	119,182	139,041	171,721	553,092	632,568	736,422
<b>SEEDS, &amp;c.:</b>	Cwt.	Cwt.	Cwt.			
Clover & grass	316,043	300,689	338,443	651,576	615,170	683,248
Cotton	Tons	Tons	Tons			
	568,928	624,765	758,152	2,973,520	3,716,567	4,881,653
Flax or linseed.	Qrs.	Qrs.	Qrs.			
Rape	1,924,008	1,588,100	2,071,534	3,541,333	3,274,988	4,397,247
	181,326	118,149	261,960	286,073	234,644	551,157
Oil-seed Cake	Tons	Tons	Tons			
	357,580	360,198	329,734	2,206,165	2,362,471	2,134,724
<b>MANURES:</b>	Tons	Tons	Tons			
Bones (burnt or not)	47,346	42,604	46,115	209,913	194,633	206,598
Guano	29,223	24,906	31,278	138,906	127,719	148,723
Nitrate of soda	104,436	108,486	113,894	1,104,587	1,183,082	1,256,658
Phosphate of lime and rock.	420,988	442,970	504,529	616,131	678,696	825,619
<b>MISCELLANEOUS:</b>	Tons	Tons	Tons			
Hay	116,913	155,395	— <sup>1</sup>	382,567	519,465	— <sup>1</sup>
Straw	102,254	78,509	— <sup>1</sup>	228,928	169,812	— <sup>1</sup>
Flax	90,098	87,334	103,598	3,581,808	3,557,101	3,942,607
Hemp	121,722	117,336	134,529	3,756,587	3,712,179	4,239,167
Hides, raw:	Cwt.	Cwt.	Cwt.			
Dry	351,762	484,218	406,314	1,078,014	1,602,944	1,484,570
Wet	508,467	533,678	546,939	1,322,874	1,493,859	1,619,719
Leather	1,137,895	1,291,937	1,068,705	8,066,235	9,642,438	8,909,964
Lard	2,012,305	2,049,367	1,965,131	3,692,573	4,361,399	4,491,539

<sup>1</sup> Figures not yet available.



## THE WEATHER DURING THE AGRICULTURAL YEAR, 1906-1907.

AN autumn in which more than half the country experienced a decided excess of rain, followed by a cold, changeable winter, formed a rather inauspicious beginning to the agricultural season of 1906-1907. The spring was, however, more favourable, a large amount of sunshine in the earlier part of the season being succeeded by copious rains, accompanied by a temperature of sufficient height to enable the crops to recover from the somewhat backward state in which they had hitherto been found. Sharp night frosts in May played havoc with some of the fruit blossoms, but did little or no harm to the cereal crops. The cool, changeable weather of the summer was happily accompanied by no great excess of rain, but with so marked an absence of genial sunshine and warmth it is rather surprising that the progress of vegetation should have been as steady as in some more favourable seasons. A late harvest is usually a catchy one, but in 1907 the conditions began to improve just at a time when dry weather was needed, so that field work proceeded with but little interruption. The fine, dry weather of September made, in fact, substantial amends for the inclemency of the summer season, and was accompanied in many districts by temperatures in excess of those experienced at any other time in the year.

### THE WINTER OF 1906-1907.

The winter of 1906-1907 was of an extremely changeable character, long stretches of cold inclement weather being interspersed with shorter periods in which the thermometer rose considerably above the average. Owing to the predominance of low temperatures the mean values for the entire winter were generally below the normal, the deficiency of warmth being greatest over eastern and southern England. The warmest weather occurred at the beginning of December and the end of February, on each of which occasions the thermometer in the shade rose to 55° and upwards in several parts of the country. During another spell of warmth in the second week of January equally high readings were recorded in a few isolated places.

The sharpest frosts occurred respectively at the end of December, and at the end of January and the beginning of February. On the former occasion the cold weather came with a very strong wind which swept down from the north-westward or northward just after Christmas, the polar current

being accompanied by considerable falls of snow, especially in the northern districts. On the night of the 25th a snow-storm passed from north-west to south-east over the whole of England, and as a result of further falls which occurred in the next four or five days a considerable portion of northern, eastern, and central England was eventually covered to the depth of more than a foot, some places in Durham and Northumberland reporting as much as 18 ins. The lowest temperatures were experienced at various times between the 26th and 31st of the month, the screened thermometer registering at least 15° of frost in many parts of the country. At Woburn, Lowestoft, Wokingham, and Llangammarch Wells (in central Wales), the thermometer fell to 13°, and at Folkestone to 12°, while at Swarraton, in Hampshire, a reading as low as 3° was recorded early in the morning of the 30th.

In the second frosty period, which commenced about January 23 and lasted until the end of the first week in February, the cold originated with a brisk easterly wind which swept across in an unbroken stream from the plains of central Europe. The lowest temperatures were recorded as a rule either on January 24-25, or on February 2 to 4. On each occasion the screened thermometer fell below 20° in many places, the lowest readings reported being—(1) on January 25, when the thermometer sank to 5° at Llangammarch Wells, and to 10° at Garforth, Stokesay, Hereford, and Hillington; and (2) on February 2 or 3, when the thermometer fell to 10° at Llangammarch Wells, and to 13° at Wokingham.

The heaviest rains of the winter occurred during the first halves of December and February, but amounts exceeding an inch in twenty-four hours were rare. Throughout the greater part of January there was a large deficiency of rain, and at a number of places an absolute drought was experienced for periods varying between a fortnight and three weeks. For the winter as a whole precipitation was considerably below the average, the midland and south-western counties receiving less than three-fourths of their due share, and the eastern counties less than two-thirds. The aggregate duration of bright sunshine was large, every district recording more than the average amount. The excess appears to have been least in the south-western and greatest in the north-eastern parts of the country; in the latter district the duration amounted to more than half as much again as the average.

Sharp gales, mainly from points between west and north-west, occurred on December 5 to 6, at the close of the same month, on January 1 to 3, and at the close of January. The worst gale of the whole winter occurred, however, between February 19 and 21, when a huge cyclonic system passed across north-

western Europe and occasioned winds of great violence from west or north-west over the entire kingdom. Throughout the winter there was, for the time of year, an unusual tendency for the development of thunderstorms, nearly all places being affected to a greater or less extent.

#### THE SPRING OF 1907.

The spring opened with fair, quiet weather, culminating at the close of March in a phenomenal spell of brilliant sunshine over nearly the entire kingdom. Later on a steady deterioration took place. April being unusually cold and ungenial, and May of a proverbially fickle character. The mean temperature of the season was above the average, but rainfall was also in excess, and the deficiency of sunshine which would have been recorded very generally was averted in the eastern and southern districts alone by the brilliant weather of March.

The warmest weather of the season occurred on May 11 or 12, when the thermometer in the shade rose to between 75° and 80° in many parts of the country, and exceeded the latter level at a few scattered places in the midland and southern counties. The only other times when the thermometer rose even as high as 70° were at the end of March when that value was exceeded at a few places in the eastern and midland districts, and on April 24, when similarly high readings were observed more generally in the south and east of England. Two days after the burst of warmth in April there were many places even in the southern parts of the country and on the coast, in which the thermometer failed to rise as high as 45°. The lowest temperatures of the spring occurred on or about March 5 or March 12, on each of which occasions a sharp frost prevailed very generally; on the latter occasion the screened thermometer fell to 20° or less in several parts of our midland and southern counties. Sharp frosts occurred also about the middle of April, mostly on the 18th or 19th, and between May 18 and 22, the latter occasioning a large amount of damage to fruit blossoms, and in some localities to the tenderer kinds of ground crops.

The rainfall of the spring was everywhere in excess of the average, the excess amounting in nearly all districts to at least 20 per cent., in the south of England to 26 per cent. and in the north-eastern counties to 28 per cent. Rainy days were also numerous, most places recording in a total of ninety-two days at least fifty with a measurable amount of rain, being eight or nine more than the average. The heaviest individual falls occurred in the western and northern parts of the country on March 16 and on May 13 and 14. In the latter case the fall

(Continued on page 294.)

**Rainfall, Temperature, and Bright Sunshine experienced over  
England and Wales during the whole of 1907, with Average  
and Extreme Values for Previous Years.**

Districts	RAINFALL							
	TOTAL FALL				NO. OF DAYS WITH RAIN			
	For 41 years, 1866-1906				For 26 years, 1881-1906			
	In 1907	Average	Extremes		In 1907	Average	Extremes	
		Driest	Wettest			Driest	Wettest	
	In.	In.	In.	In.				
North-eastern	24.3	25.6	19.9 (1884)	37.2 (1872)	196	185	162 (1884)	208 (1894)
Eastern	21.5	24.8	19.1 (1874 and 1887)	33.1 (1872)	182	179	156 (1898)	205 (1894)
Midland	28.6	27.6	19.2 (1887)	39.8 (1872)	194	178	148 (1887)	210 (1882)
Southern	26.6	28.5	21.5 (1887)	41.7 (1872)	179	173	137 (1899)	197 (1882 and 1903)
North-western with North Wales	36.6	37.8	24.9 (1887)	59.2 (1872)	221	198	163 (1887)	226 (1903)
South-western with South Wales	41.1	41.9	28.3 (1887)	68.6 (1872)	222	198	159 (1887)	235 (1882)
Channel Islands <sup>1</sup>	30.4	32.5	26.2 (1887)	39.5 (1882)	197	212	160 (1899)	251 (1886)

Districts	MEAN TEMPERATURE				HOURS OF BRIGHT SUNSHINE			
	For 41 years, 1866-1906				For 26 years, 1881-1906			
	In 1907	Average	Extremes		In 1907	Average	Extremes	
			Coldest	Warmest			Cloudiest	Sunniest
	°	°	°	°				
North-eastern	47.6	47.5	45.0 (1879)	49.2 (1898)	1483	1321	1006 (1885)	1801 (1906)
Eastern	48.8	48.5	45.8 (1879)	51.0 (1868)	1569	1589	1267 (1888)	1864 (1899)
Midland	48.0	48.4	45.8 (1879)	51.1 (1868)	1397	1408	1173 (1888)	1715 (1893)
Southern	49.5	49.6	46.9 (1879)	51.6 (1898)	1634	1605	1245 (1888)	1983 (1899)
North-western with North Wales	48.0	48.5	45.9 (1879)	50.3 (1868 and 1893)	1370	1389	1196 (1888)	1683 (1901)
South-western with South Wales	49.0	50.2	48.3 (1888)	52.8 (1868)	1519	1652	1459 (1888)	1964 (1893)
Channel Islands <sup>1</sup>	52.1	52.2	50.7 (1885)	54.3 (1899)	1765	1901	1710 (1888)	2300 (1893)

NOTE.—The above Table is compiled from information given in the **Weekly Weather Report of the Meteorological Office.**

<sup>1</sup> For the Channel Islands the "Averages" and "Extremes" of Rainfall and Mean Temperature are for the twenty-six years, 1881-1906.

The Rainfall of 1907 and of the previous Ten Years, with the Average Annual Fall for a long period, as observed at thirty-eight stations situated in various parts of the United Kingdom.

Stations	1907		Rainfall of Previous Years										Average rainfall
	Total rainfall	Difference from average.	1906	1905	1904	1903	1902	1901	1900	1899	1898	1897	
			In.	In.	In.	In.	In.	In.	In.	In.	In.	In.	
<b>ENGLAND AND WALES:</b>	In.	Per cent.	In.	In.	In.	In.	In.	In.	In.	In.	In.	In.	In.
Durham . . . . .	248	- 9	238	192	190	308	185	229	288	245	208	218	272
York . . . . .	256	+ 1	228	207	208	303	187	205	268	224	237	244	253
Hillington . . . . .	257	- 7	316	227	257	356	262	244	326	247	221	263	275
Yarmouth . . . . .	219	-13	280	226	210	251	214	212	247	234	200	208	253
Cambridge . . . . .	212	- 7	224	190	176	305	158	167	197	193	179	204	227
Rothamsted . . . . .	253	- 9	268	248	232	363	196	211	271	251	187	250	279
Nottingham . . . . .	235	- 5	218	186	200	322	215	204	285	226	195	234	248
Cheadle . . . . .	319	- 3	343	267	263	392	264	277	375	309	278	328	328
Hereford . . . . .	297	+10	236	240	250	378	243	252	328	267	224	267	270
Cirencester . . . . .	289	- 6	262	251	268	411	251	261	310	268	221	327	307
Oxford . . . . .	269	+ 8	240	210	227	359	167	223	236	210	181	263	250
London . . . . .	195	-20	222	230	202	380	204	215	222	220	178	233	244
Hastings . . . . .	233	-20	287	269	246	323	230	194	298	258	230	281	291
Southampton . . . . .	308	0	331	262	310	432	274	283	316	276	266	326	309
Stonyhurst . . . . .	500	+ 7	497	388	396	589	368	390	483	476	479	513	468
Manchester . . . . .	404	+ 9	422	333	320	452	265	333	428	335	332	391	370
Liverpool . . . . .	266	- 8	281	240	25	344	256	251	319	276	256	284	288
Llandudno . . . . .	263	-15	316	261	260	385	250	287	328	324	313	307	308
Pembroke . . . . .	372	+ 6	425	282	318	458	309	330	406	350	355	381	351
Clifton . . . . .	343	- 1	301	250	309	428	265	266	377	355	309	389	346
Cullompton . . . . .	334	- 6	339	281	349	427	308	311	355	370	299	389	357
Plymouth . . . . .	363	+ 1	334	305	414	458	309	330	403	331	292	404	359
Scilly (St. Mary's) . . . . .	293	-13	298	275	344	399	253	326	341	319	271	357	336
Jersey (St. Aubin's) . . . . .	286	-16	292	303	373	382	304	296	346	293	300	362	342
<b>Mean for the whole of England and Wales</b>	299	- 4	299	256	280	375	267	274	323	286	262	313	310
<b>SCOTLAND:</b>													
Stornoway . . . . .	438	-10	422	507	557	621	463	428	625	599	716	452	486
Wick . . . . .	296	+ 1	332	323	253	359	264	321	331	297	274	219	293
Aberdeen . . . . .	287	- 7	315	285	237	363	273	280	340	303	275	287	307
Balmoral <sup>1</sup> . . . . .	318	-12	391	356	249	441	318	314	405	356	365	368	360
Leith . . . . .	307	+29	302	192	234	309	164	225	312	248	199	205	238
Marchmont . . . . .	333	- 3	389	274	261	386	244	272	438	326	283	290	344
Fort Augustus . . . . .	420	- 6	516	436	444	680	356	369	505	423	543	419	446
Glasgow . . . . .	426	+10	401	307	337	533	291	329	470	435	374	387	387
<b>Mean for the whole of Scotland</b>	445	+ 6	463	414	421	571	430	408	522	461	474	415	418
<b>IRELAND:</b>													
Belfast . . . . .	381	+13	362	318	318	423	358	321	406	349	303	357	336
Markree Castle . . . . .	452	+ 8	416	390	449	541	384	449	453	437	404	461	420
Armagh . . . . .	316	- 1	301	299	309	363	317	321	364	325	318	351	319
Dublin . . . . .	270	- 4	228	253	222	316	284	261	343	277	271	294	280
Parsonstown . . . . .	339	+ 3	326	257	329	408	282	311	385	331	342	378	330
Kilkenny . . . . .	324	- 3	287	250	315	420	331	303	392	309	291	414	353
<b>Mean for the whole of Ireland</b>	397	+ 1	367	346	389	479	372	377	449	406	386	445	395

<sup>1</sup> The Average Fall is in nearly all cases deduced from observations extending over the thirty-five years 1871-1905.

<sup>2</sup> The Mean Rainfall for each country is based upon observations made at a large number of stations in addition to those given above.

<sup>3</sup> The figures for the years prior to 1906 are for Braemar, which ceased reporting after 1905.

[Continued from page 291.]

commenced with a sharp thunderstorm and was especially heavy in the midlands, 2.0 in. falling at Edgbaston, Birmingham, in fourteen hours, and 2.8 in. at Great Billing, near Northampton, in twenty hours. A snowstorm of unusual severity, for so late a period in the season, was experienced in the south-east of England on the night of April 6; on some parts of the Surrey hills the ground was covered to the depth of 6 in. The total duration of bright sunshine in the spring was in excess of the average in the south and east of England, but rather deficient elsewhere. During the brilliantly fine week which occurred at the end of March many places recorded a mean of ten or eleven hours per day, the total for the week being equal to between 80 and 85 per cent. of the possible duration.

#### THE SUMMER OF 1907.

The summer was distinguished by a striking absence of sunshine and seasonable warmth, and by frequent rains, the latter being, however, usually light in the eastern and southern districts.

Throughout the entire season there was only one week in which the thermometer rose to any considerable extent above the average. In the period thus favoured, the third week in July, the shade temperature over central and southern England rose to a little above 80°. In our eastern and north-eastern counties it went very little above 75°, but in Scotland it rose to even a higher level than in the south of England, the highest point of all (86°) being attained as far north as Lairg, in Sutherlandshire. Excepting in this one warm week the thermometer, even in the most favoured districts, scarcely ever rose much above 75°, for a large portion of the time it never went above 70°, and on many occasions, especially in the northern districts, it failed to reach 60°. The coolest weather of all occurred during the last week in June and the first two weeks in July. Over the country, as a whole, the middle week in this very inclement period was the coldest experienced in July since the year 1890, the mean temperature for the whole week being at least 8° below the average in several parts of the country, and as many as 9° below it at Nottingham. On the nights of June 29 and July 10, a slight ground frost was experienced locally in the more central parts of England and Wales, and on the evening of Midsummer Day a little snow fell at Harrogate. In the eastern counties the summer was upon the whole less cool than in 1902 or 1903, but over by far the greater part of England it was the coolest since the miserably inclement season of 1888.

The rainfall of the season was marked by frequency, rather than by intensity. In the western and central parts of the kingdom the total amount was in excess of the average, but in all the eastern and southern districts there was a considerable deficit, the eastern counties receiving little more than two-thirds, and the Channel Islands less than two-thirds of the normal quantity. All districts reported more than the average number of rainy days, but in the eastern parts of the country the departure from the normal was extremely small. The largest individual falls of rain of anything like a general character occurred on July 10 in the west of England, on July 21 and 22 in many parts of our western and southern counties, on August 14 at a number of places in the west and north, and on August 17 at a few southern stations.

Thunderstorms occurred at frequent intervals but were, as a rule, of no great severity, the chief exceptions being noted on July 21 and 22, when storms of extraordinary violence (accompanied in many places by destructive hail showers) were experienced in several parts of Wales and the west of England. At Bath the rain which fell during this storm amounted, in the space of three hours, to more than  $2\frac{1}{2}$  in.

#### THE AUTUMN OF 1907.

The cool, changeable weather of the summer continued through the early days of September. At the close of the first week, however, a decided improvement took place, and for the remainder of the month the weather was extremely fine, the temperatures recorded in the south and east of England on the 25th being the highest of the whole year. In October the conditions were very unsettled, with frequent falls of rain in all districts, but with a temperature in excess of the average. November proved much drier, and was again mild. The tendency for fog being quite in accordance with the tradition attaching to the month.

For the season as a whole the temperature was well in excess of the average, especially in the south and east of England. The warmest weather occurred at various times in September, mainly on the 12th to 13th, or on the 25th, but at some north-western stations on the 28th. On each occasion the thermometer rose to between  $75^{\circ}$  and  $80^{\circ}$  in many places, and on the 25th the latter point was exceeded in inland portions of the south and east of England, the highest readings reported being  $84^{\circ}$  at Epsom and  $83^{\circ}$  at Greenwich. After the close of September no place in the United Kingdom appears to have experienced a shade temperature as high as  $70^{\circ}$ . The lowest autumn temperatures occurred at varying times in the

latter half of November, mainly about the 19th, the 29th and the 30th, on each of which occasions a sharp frost was sent over a large portion of the country. At Garf the 19th, and at Marlborough on the 30th, the thermometer fell to a minimum of 19°.

The autumn rainfall was slightly in excess of the average in the central and southern parts of the kingdom, but deficient in all other districts. In the east of England the total amount was little more than three-fourths of the average. Individual falls of any great weight were rare, but on the 15th and 16th a heavy downpour was experienced, first in the south of Scotland, and afterwards in many parts of England. In the former country 2·5 in. or rather more was recorded. On the 15th at Leith, Glasgow, and Thornton Hall, where in England 1½ in. was collected in many places next to London. In Lincoln and its immediate vicinity the amount ranged from 1½ in. to 3½ in. Another heavy fall occurred in Cornwall on November 2, Falmouth registering as much as 2·2 in. On September 7 and 30 many places in England and Wales failed to record any measurable quantity of precipitation, in some others the only water found in the rain-gauge was deposited either by dew or by wet fog. Thunderstorms were less frequent than in the earlier part of the year, the only case of anything like a general character occurring on November 27, when most places recorded either rain, storms or thunder or lightning alone. The total amount of bright sunshine in the autumn was everywhere less than in the summer, the greatest excess occurring in the north-eastern counties.

FREDERICK J. BROOKS

12 Patten Road,  
Wandsworth Common.



# Royal Agricultural Society of England.

(Established May 9, 1838, as the ENGLISH AGRICULTURAL SOCIETY, and  
Incorporated by Royal Charter on March 26, 1840.)

## Patron.

HIS MOST GRACIOUS MAJESTY THE KING.

## President for 1908.

The Right Hon. VICTOR C. W. CAVENDISH, M.P.

## Trustees.

Year when elected on Council	
1895	H.R.H. THE PRINCE OF WALES, K.G., <i>Marlborough House, S.W.</i>
1895	BEDFORD, Duke of, K.G., <i>Woburn Abbey, Bedfordshire.</i>
1882	CAWDOR, Earl, <i>Stackpole Court, Pembrokeshire.</i>
1893	CORNWALLIS, F. S. W., <i>Linton Park, Maidstone, Kent.</i>
1885	COVENTRY, Earl of, <i>Croome Court, Severn Stoke, Worcestershire.</i>
1895	DERBY, Earl of, K.G., <i>Knowsley, Prescott, Lancashire.</i>
1871	EGERTON OF TATTON, Earl, <i>Tatton Park, Knutsford, Cheshire.</i>
1881	GILBEY, Sir WALTER, Bart., <i>Elsenham Hall, Elsenham, Essex.</i>
1899	MIDDLETON, Lord, <i>Birdaill House, York.</i>
1880	MORETON, Lord, <i>Sarsden House, Chipping Norton, Oxon.</i>
1874	SPENCER, Earl, K.G., <i>Althorp, Northampton.</i>
1881	THOROLD, Sir JOHN H., Bart., <i>Syston Park, Grantham, Lincolnshire.</i>

## Vice-Presidents.

1889	H.R.H. PRINCE CHRISTIAN, K.G., <i>Cumberland Lodge, Windsor.</i>
1871	BOWEN-JONES, J., <i>St. Mary's Court, Shrewsbury.</i>
1898	CAVENDISH, Rt. Hon. VICTOR C. W., M.P., <i>Holker Hall, Lancashire.</i>
1872-74	} CHAPLIN, Rt. Hon. HENRY, M.P., <i>Stafford House, St. James's, S.W.</i>
1884	
1887	CRUTCHLEY, PERCY, <i>Sunninghill Lodge, Ascot, Berkshire.</i>
1891	DUGDALE, J. MARSHALL, <i>Llwyn, Llanfyllin, S.O., Mont.</i>
1903	FELLOWES, Rt. Hon. AILWYN E., <i>Honingham, Norwich.</i>
1876	FEVERSHAM, Earl of, <i>Duncombe Park, Helmsley, Yorkshire.</i>
1883-90	} JERSEY, Earl of, G.C.B., G.C.M.G., <i>Middleton Park, Bicester, Oxon.</i>
1894	
1899	NORTHBROOK, Earl of, <i>Stratton, Micheldever, Hampshire.</i>
1881	PARKER, Hon. CECIL T., <i>Eccleston, Chester.</i>
1907	YARBOROUGH, Earl of, <i>Brocklesby Park, Lincolnshire.</i>

*List of Council of the Society.*

**Ordinary Members of the Council.**

Year when first elected on Council	
1905	ADAMS, GEORGE. <i>Royal Prize Farm, Faringdon (Berkshire).</i>
1905	ADEANE, CHAS. R. W., <i>Babraham Hall, Cambridge (Cambridgeshire).</i>
1905	AVELING, THOMAS L., <i>Boley Hill House, Rochester (Kent).</i>
1905	BANKART, S. N., <i>Hallaton Hall, Uppingham (Rutland).</i>
1906	BROCKLEHURST HENRY DENT, <i>Sudeley Castle, Winchcombe (Gloucestershire).</i>
1906	BUTTAR, THOMAS A., <i>Corston, Coupar Angus (Scotland).</i>
1905	CARDEN, RICHARD G., <i>Fishmoyne, Borrialeigh, Tipperary (Ireland).</i>
1905	CARR, RICHARDSON, <i>Estate Office, Tring Park (Hertfordshire).</i>
1905	COOPER, Sir RICHARD P., Bart., <i>Shenstone Court, Lichfield (Staffs).</i>
1906	DE TRAFFORD, Sir H. F., Bart., <i>Hill Crest, Market Harborough (Leicestershire).</i>
1906	DUDDING, HENRY, <i>Riby Grove, Stallingborough (Lincolnshire).</i>
1905	EADIE, JOHN T. C., <i>The Rock, Newton Solney, Burton-on-Trent (Derbyshire).</i>
1905	FALCONER, JAMES, <i>Northbrook Farm, Micheldever Station (Hampshire).</i>
1905	FORREST, ROBERT, <i>St. Fagan's, Cardiff (Glamorganshire).</i>
1907	FRANK, HOWARD, <i>9 Conduit Street, W. (London).</i>
1906	GLOVER, JAMES W., <i>12 Jury Street, Warwick (Warwickshire).</i>
1900	GREAVES, R. M., <i>Wern, Portmadoc (North Wales).</i>
1904	GREENALL, Sir GILBERT, Bart <i>Walton Hall, Warrington (Cheshire).</i>
1907	HAMLYN, ERNEST A <i>Oakdale, Orkley Surrey).</i>
1905	HARRIS, JOSEPH, <i>Brackenbrough Tower, Carlisle (Cumberland).</i>
1903	HARRISON WILLIAM, <i>Hall House, Leigh (Lancashire).</i>
1905	HINE, JOHN HENRY, <i>Pomphlett Farm, Plymouth (Devon).</i>
1906	HIPPISLEY, R. J. BAYNTON, <i>Ston Easton Park, Bath (Somerset).</i>
1905	HISCOCK, ARTHUR, <i>Mano Farm Motcombe, Shaftesbury (Dorset).</i>
1903	HOBBS, ROBERT W <i>Kelmescott Lechlade (Oxfordshire).</i>
1900	HOWARD, JOHN HOWARD, <i>Clapham Park, near Bedford (Bedfordshire).</i>
1905	INGRAM, WALTER F., <i>2 St. Andrew's Place, Leices (Sussex).</i>
1905	KNIGHTLEY, Sir CHARLES V., Bart., <i>Fawsley, Daventry (Northants).</i>
1905	LOBB, GEORGE, <i>Lawhitton, Launceston (Cornwall).</i>
1904	MATHEWS, ERNEST, <i>Little Shardeloes, Amersham (Buckinghamshire).</i>
1905	MAY WILLIAM A., <i>3 Wellington Street, Strand, W.C. (London).</i>
1904	MIDDLETON CHRISTOPHER, <i>Vane Terrace, Darlington (Durham).</i>
1884	MILLER, T HORROCKS, <i>Singleton Park, Poulton-le-Fylde (Lancashire).</i>
1905	MINTON, THOMAS S. <i>Montford Shrewsbury (Shropshire).</i>
1907	NOCTON, WILLIAM, <i>Langham Hall, Colchester (Essex).</i>
1907	PATERSON, R. G., <i>cton Hill, Stafford (Staffordshire).</i>
1905	PILKINGTON, CLAUDE M. S., <i>Vollaton, Nottingham (Nottinghamshire).</i>
1906	PLUMPTRE, H. FITZWALTER, <i>Goodnestone, Dover (Kent).</i>
1905	REA, GEORGE GREY, <i>Middleton, Wooler (Northumberland).</i>
1897	REYNARD, FREDERICK, <i>Sunderlandwick, Driffield (Yorks., E. Riding).</i>
1905	RICHMOND AND GORDON Duke of K.G., <i>Goodwood, Chichester (Sussex).</i>
1905	ROGERS, C. COLTMAN, <i>Stanage Park, Brampton Bryan (South Wales).</i>
1905	ROWELL, JOHN, <i>Bury, Huntingdon (Huntingdonshire).</i>
1901	SCORY, WILLIAM, <i>Hobground House, Sinnington, York (Yorkshire, North Riding).</i>
1903	SHACKLE, ERNEST W., <i>Redleaf, Hayes (Middlesex).</i>
1907	SMITH, FRED, <i>Woodbridge (Suffolk).</i>
1905	SMITH, HENRY HERBERT, <i>Boicood, Calne (Wiltshire).</i>
1891	STANYFORD, E. WILFRID, <i>Kirk Hammerton Hall, York (Yorkshire, West Riding).</i>
875	STRATTON, RICHARD, <i>The Duffryn, Newport (Monmouthshire).</i>
1905	TALLET, HERBERT, <i>Vestacre, Swaffham (Norfolk).</i>
1905	TAYLOR, GEORGE, <i>Cranford (Middlesex).</i>
1905	THORNTON, JOHN, <i>7 Princes Street Hanover Square, W. (London).</i>
1907	TINDALL, C. W., <i>Waffleet, S.O (Lincolnshire).</i>
1904	TURNER, ARTHUR P <i>The Leen, Pembridge (Herefordshire).</i>
1889	WHEELER, E. VINCENT V., <i>Newnham Court, Tenbury (Worcestershire).</i>
1889	WILSON, CHRISTOPHER W., <i>Rigmaden Park, Kirbby Lonsdale (Westmorland).</i>

**STANDING COMMITTEES.**

\* \* Under By-law 39, the PRESIDENT is a Member *ex officio* of all Committees, and the TRUSTEES and VICE-PRESIDENTS are Members *ex officio* of all Standing Committees except the Committee of Selection.

*The Honorary Director is a Member ex officio of all Committees.*

**Finance and House Committee.**

ADEANE, C. R. W. ( <i>Chairman</i> ).	CARR, RICHARDSON.
NORTHBROOK, Earl of.	CORNWALLIS, F. S. W.
COOPER, Sir R. P., Bart.	CRUTCHLEY, PERCY.
GREENALL, Sir G., Bart.	HARRISON, W.
THOROLD, Sir J. H., Bart.	MATHEWS, ERNEST.
AVELING, T. L.	WHEELER, E. V. V.

**Journal and Education Committee.**

THOROLD, Sir J. H., Bart. ( <i>Chairman</i> ).	BOWEN-JONES, J.	MATHEWS, ERNEST.
DERBY, Earl of, K.G.	BROCKLEHURST, H. D.	MAY, W. A.
JERSEY, Earl of, G.C.B.	CORNWALLIS, F. S. W.	PATTERSON, R. G.
MORETON, Lord.	DUGDALE, J. MARSHALL.	PLUMPTRE, H. F.
ADEANE, C. R. W.	HIPPISLEY, R. J. B.	WHEELER, E. V. V.

**Chemical and Woburn Committee.**

BOWEN-JONES, J. ( <i>Chairman</i> ).	GREAVES, R. M.	PATTERSON, R. G.
RICHMOND AND GORDON, Duke of.	HOWARD, JOHN HOWARD.	PILKINGTON, C. M. S.
KNIGHTLEY, Sir C. V., Bart.	INGRAM, W. F.	REYNARD, F.
BROCKLEHURST, H. D.	LOBB, GEORGE.	SCOBY, W.
FALCONER, J.	MIDDLETON, C.	TINDALL, C. W.
	MINTON, T. S.	TURNER, A. P.

**Botanical and Zoological Committee.**

WHEELER, E. V. V. ( <i>Chairman</i> ).	BOWEN-JONES, J.	PLUMPTRE, H. F.
MORETON, Lord.	CORNWALLIS, F. S. W.	ROGERS, C. C.
THOROLD, Sir J. H., Bart.	HAMLIN, E. A.	SHACKLE, E. W.
	MIDDLETON, C.	TALLENT, H.

**Veterinary Committee.**

NORTHBROOK, Earl of ( <i>Chairman</i> ).	CRUTCHLEY, PERCY.	*PRESIDENT OF ROYAL COLLEGE OF VET. SURGEONS.
DERBY, Earl of, K.G.	EADIE, J. T. C.	ROWELL, JOHN.
MORETON, Lord.	HARRIS, JOSEPH.	SHACKLE, E. W.
CAVENDISH, Rt. Hon. V.	HISCOCK, A.	SMITH, FRED.
FELLOWES, Rt. Hon. A. E.	*MCFADYEAN, Prof. Sir J.	STANYFORTH, E. W.
PARKER, Hon. C. T.	*MASTER OF FARRIERS' COMPANY.	SWITHINBANK, H.
GREENALL, Sir G., Bart.	MATHEWS, ERNEST.	WILSON, C. W.
THOROLD, Sir J. H., Bart.	MILLER, T. H.	
BANKART, S. N.		

\* *Professional Members of Veterinary Committee not Members of Council.*

**Stock Prizes Committee.**

REYNARD, F. ( <i>Chairman</i> ).	CARR, RICHARDSON.	REA, G. G.
COVENTRY, Earl of.	CRUTCHLEY, PERCY.	ROGERS, C. C.
NORTHBROOK, Earl of.	DUDDING, H.	ROWELL, JOHN.
MIDDLETON, Lord.	EADIE, J. T. C.	STRATTON, R.
FELLOWES, Rt. Hon. A. E.	FRANK, HOWARD.	TAYLOR, GEORGE.
COOPER, Sir R. P., Bart.	GREAVES, R. M.	THORNTON, JOHN.
DE TRAFFORD, Sir H. F., Bt.	HINE, J. H.	TINDALL, C. W.
GREENALL, Sir G., Bart.	HOBBS, ROBERT W.	TURNER, A. P.
ADAMS, GEORGE.	INGRAM, W. F.	WILSON, C. W.
BOWEN-JONES, J.	MATHEWS, ERNEST.	The Stewards of Live Stock.
BUTTAR, T. A.	MILLER, T. H.	
CARDEN, R. G.	MINTON, T. S.	

*Standing Committees.***Implement Committee.**

GREAVES, R. M. (Chairman).	GLOVER, J. W.	PILKINGTON, C. M. S.
PARKER, Hon. C. T.	HARRISON, W.	STANYFORTH, E. W.
AVELING, T. L.	HIPPISLEY, R. J. B.	TALLEN, H.
BOWEN-JONES, J.	HOWARD, JOHN HOWARD.	WHEELER, E. V. V.
CRUTCHLEY, PERCY.	MIDDLETON, C.	The Stewards of Implements.
FALCONER, J.	PATTERSON, R. G.	

**Showyard Works Committee.**

GREENALL, Sir G., Bart. (Chairman).	CRUTCHLEY, PERCY.	PILKINGTON, C. M. S.
COOPER, Sir R. P., Bart.	FORREST, R.	REA, G. G.
AVELING, T. L.	HARRISON, W.	REYNARD, F.
CARR, RICHARDSON.	HOWARD, J. H.	STANYFORTH, E. W.
	NOCTON, WM.	TAYLOR, GEORGE.

**Committee of Selection.**

THOROLD, Sir J. H., Bart. (Chairman).	FELLOWES, Rt. Hon. A. E.	CARR, RICHARDSON.
THE PRESIDENT.	PARKER, Hon. C. T.	CORNWALLIS, F. S. W.
	COOPER, Sir R. P., Bart.	ROWELL, JOHN.

And the Chairman of each of the Standing Committees.

**Dairy and Produce Committee.**

MATHEWS, ERNEST (Chairman).	CARR, RICHARDSON.	PLUMPTRE, H. F.
DERBY, Earl of, K.G.	CRUTCHLEY, PERCY.	SMITH, FRED.
PARKER, Hon. C. T.	GREAVES, R. M.	TAYLOR, GEORGE.
THOROLD, Sir J. H., Bart.	HINE, J. H.	WHEELER, E. V. V.
	HISCOCK, A.	

**General Newcastle Committee.**

THE WHOLE COUNCIL, with the following representatives of the LOCAL COMMITTEE:—

SANDERSON, Rt. Hon. W. J. (Lord Mayor of Newcastle).	BOLAM, W. J.	OUBRIDGE, J. M.
NORTHUMBERLAND, Duke of, K.G.	CHRISTAL, WILLIAM.	WALKER, J. D.
ELLIS, Sir JOSEPH B.	FITZGERALD, JOHN.	WALLACE, JOHNSTONE.
	GILLESPIE, J. J.	OLIVER, A. M.
	LEE, WALTER.	(Local Secretary).

**Honorary Director.**

SIR GILBERT GREENALL, BART.

**Secretary.**

THOMAS MCRROW, 16 Bedford Square, W.C.

*Consulting Chemist.*—Dr. J. AUGUSTUS VOELCKER, M.A., F.I.C., 22 Tudor Street, London, E.C.

*Consulting Botanist.*—W. CARRUTHERS, F.R.S., 44 Central Hill, Norwood, S.E.

*Consulting Veterinary Surgeon.*—Prof. Sir JOHN MCFADYEN, Royal Veterinary College, Camden Town, N.W.

*Zoologist.*—CECIL WARBURTON, M.A., Zoological Laboratory, Cambridge.

*Consulting Engineer.*—F. S. COURTNEY, 25 Victoria Street, Westminster, S.W.

*Surveyor.*—J. R. NAYLOR, F.R.I.B.A., Smith's Bank Chambers, Derby.

*Consulting Surveyor.*—GEORGE HUNT, Evesham, Worcestershire.

*Publisher.*—JOHN MURRAY, 50A Albemarle Street, W.

*Solicitors.*—GAERARD, JAMES & WOLFE, 13 Suffolk Street, Pall Mall East, S.W.

*Bankers.*—THE LONDON AND WESTMINSTER BANK, St. James's Square Branch.

*Distribution of Governors and Members of the Society.* v

**DISTRIBUTION OF GOVERNORS AND MEMBERS OF THE  
SOCIETY, AND OF ORDINARY MEMBERS OF THE COUNCIL.**

*(Elected in accordance with the By-laws enacted on May 31, 1905,  
and numbered 57-94.)*

ELECTORAL DISTRICT	DIVISION	NUMBER OF GOVERNORS AND MEMBERS	NUMBER OF ORDINARY MEMBERS OF COUNCIL	ORDINARY MEMBERS OF COUNCIL
A.	BEDFORDSHIRE . . . . .	108	1	J. H. Howard.
	CHESHIRE . . . . .	263	1	Sir Gilbert Greenall.
	CORNWALL . . . . .	92	1	G. Lobb.
	DERBYSHIRE . . . . .	168	1	J. T. C. Eadie.
	DORSET . . . . .	68	1	A. Hiscock.
	HAMPSHIRE AND CHANNEL ISLANDS	230	1	J. Falconer.
	HERTFORDSHIRE . . . . .	262	1	Richardson Carr.
	LANCASHIRE AND ISLE OF MAN. . . . .	316	2	W. Harrison ; T. H. Miller.
	MIDDLESEX . . . . .	178	2	E. W. Shackle ; G. Taylor.
	MONMOUTHSHIRE . . . . .	60	1	R. Stratton.
	NORFOLK . . . . .	270	1	H. Tallent.
	NORTHAMPTONSHIRE	203	1	Sir C. V. Knightley.
	NORTHUMBERLAND . . . . .	196	1	G. G. Rea.
	STAFFORDSHIRE . . . . .	307	2	Sir R. P. Cooper ; R. G. Patterson.
	WORCESTERSHIRE . . . . .	170	1	E. V. V. Wheeler.
YORKSHIRE, N.R. . . . .	167	1	W. Scoby.	
SCOTLAND. . . . .	209	1	T. A. Buttar.	
	— 3,267 —	— 20 —		
B.	BUCKINGHAMSHIRE . . . . .	160	1	E. Mathews.
	DEVON . . . . .	158	1	J. H. Hine.
	DURHAM . . . . .	125	1	C. Middleton.
	ESSEX . . . . .	210	1	W. Nocton.

vi *Distribution of Governors and Members of the Society.*

**DISTRIBUTION OF GOVERNORS AND MEMBERS OF THE SOCIETY—continued.**

ELECTORAL DISTRICT	DIVISION	NUMBER OF GOVERNORS AND MEMBERS	NUMBER OF ORDINARY MEMBERS OF COUNCIL	ORDINARY MEMBERS OF COUNCIL	
B. <i>Contd.</i>	HEREFORDSHIRE . . .	134	1	A. P. Turner.	
	LEICESTERSHIRE . . .	290	1	Sir H. F. de Trafford.	
	LONDON . . . . .	596	3	{ Howard Frank; W. A. May; John Thornton.	
	NOTTINGHAMSHIRE . . .	163	1	C. M. S. Pilkington.	
	RUTLAND . . . . .	22	1	S. N. Bankart.	
	SHROPSHIRE . . . . .	293	1	T. S. Minton.	
	SUFFOLK . . . . .	217	1	Fred Smith.	
	SURREY . . . . .	228	1	E. A. Hamlyn.	
	WILTSHIRE . . . . .	119	1	H. H. Smith.	
	YORKSHIRE, W.R. . . . .	258	1	E. W. Stanyforth.	
	SOUTH WALES . . . . .	113	1	C. C. Rogers.	
		—3,086	—	17	
	C.	BERKSHIRE . . . . .	224	1	George Adams.
		CAMBRIDGESHIRE . . . .	168	1	C. R. W. Adeane.
CUMBERLAND . . . . .		116	1	Joseph Harris.	
GLAMORGAN . . . . .		80	1	R. Forrest.	
GLOUCESTERSHIRE . . . .		254	1	H. D. Brocklehurst.	
HUNTINGDONSHIRE . . . .		48	1	John Rowell.	
KENT . . . . .		435	2	{ T. L. Aveling; H. F. Plumptre.	
LINCOLNSHIRE . . . . .		371	2	{ Henry Dudding; C. W. Tindall.	
OXFORDSHIRE . . . . .		146	1	R. W. Hobbs.	
SOMERSET . . . . .		119	1	R. J. Bayntun Hippisley.	
SUSSEX . . . . .		312	2	{ W. F. Ingram; Duke of Richmond and Gordon.	
WARWICKSHIRE . . . . .		258	1	J. W. Glover.	
WESTMORLAND . . . . .		62	1	C. W. Wilson.	
YORKSHIRE, E.R. . . . .		116	1	F. Reynard.	
IRELAND . . . . .	135	1	R. G. Carden.		
NORTH WALES . . . . .	169	1	R. M. Greaves.		
	—3,013	—	19		
FOREIGN COUNTRIES. . . .		280			
MEMBERS WITH NO ADDRESSES		23			
<b>GRAND TOTALS . . . . .</b>		<b>9,669</b>	<b>56</b>		

## GOVERNORS OF THE SOCIETY.

	Date of election as Member	Date of election as Governor
HIS MAJESTY THE KING...Windsor Castle . . . . .	—	Feb. 3, 1864
T † H.R.H. THE PRINCE OF WALES, K.G....Marlborough House, S.W., and Sandringham, Norfolk . . . . .	—	April 6, 1892
VP H.R.H. PRINCE CHRISTIAN OF SCHLESWIG-HOLSTEIN, K.G....Cumberland Lodge, Windsor . . . . .	—	Aug. 4, 1875
† ABERDARE, Lord...Longwood, Winchester . . . . .	April 1, 1885	Aug. 1, 1905
† ACLAND, Alfred Dyke...Digswell House, Welwyn . . . . .	Oct. 8, 1902	Feb. 4, 1903
† ADEANE, C. R. W....Babraham Hall, Cambridge . . . . .	Nov. 6, 1889	Jan. 10, 1906
ALINGTON, Lord...Crichel, Wimborne . . . . .	May 7, 1879	April 4, 1906
† ALLCROFT, Herbert John...Stokesay Court, Onibury, Salop . . . . .	—	Dec. 12, 1888
† AMHERST OF HACKNEY, Lord...Didlington Hall, Brandon . . . . .	Feb. 2, 1859	May 7, 1890
ANCASTER, Earl of...Normanton Park, Stamford . . . . .	Mar. 3, 1869	May 5, 1875
ANN, Sir Edwin T....West Parkfields, Kedleston Road, Derby . . . . .	—	Aug. 1, 1906
ARCHER-HOUBLON, George B....Hallingbury Place, Bishop's Stortford . . . . .	—	Mar. 6, 1889
ASHWORTH, Alfred...Horsley Hall, Gresford . . . . .	Dec. 2, 1868	Feb. 1, 1905
† ASSHETON, R. C....Hall Foot, Clitheroe . . . . .	Mar. 6, 1884	May 30, 1906
ASTOR, Waldorf, jun....Cliveden, Taplow, Bucks. . . . .	—	Jan. 30, 1907
AUBREY-FLETCHER, Rt. Hon. Sir Henry, Bart., M.P. ....Ham Manor, Angmering, Sussex . . . . .	June 6, 1883	July 31, 1907
BARING, Godfrey, M.P....Nubia House, Cowes, Isle of Wight . . . . .	—	May 2, 1906
BARNARD, Lord...Raby Castle, Darlington . . . . .	—	July 27, 1892
BARRYMORE, Lord...20 Hill Street, Berkeley Square, W. . . . .	Feb. 4, 1885	April 4, 1906
BATH, Marquis of...Longleat, Warminster . . . . .	June 22, 1892	April 4, 1906
BATHURST, Earl, C.M.G....Cirencester House, Cirencester . . . . .	July 3, 1869	April 4, 1906
BECK, A. Cecil, M.P....Harrod Hall, Bedford . . . . .	—	Jan. 30, 1907
T † BEDFORD, Duke of, K.G....Woburn Abbey, Bedfordshire . . . . .	—	May 3, 1893
† BEEVER, W. F. Holt...Yewden Lodge, Henley-on-Thames . . . . .	April 2, 1879	June 6, 1894
† BELPER, Lord...Kingston Hall, Notts. . . . .	July 6, 1881	Mar. 6, 1895
† BENN, Thomas G....Thornton Gate, Rossall Beach, Fleetwood, R.S.O. . . . .	Mar. 13, 1878	Aug. 2, 1882
BENTINCK, Lord Henry...Underley, Kirkby Lonsdale . . . . .	Dec. 12, 1888	Jan. 10, 1906
BEVAN, Francis A....54 Lombard Street, E.C. (representing Messrs. Barclay & Co. Ltd.) . . . . .	—	Dec. 11, 1907
BINNEY, J....Pampi-ford Hall, near Cambridge . . . . .	—	Jan. 10, 1906
BIRKIN, Sir T. I. Bart....Ruddington Grange, near Nottingham . . . . .	Dec. 10, 1880	May 2, 1906
† BLYTH, Lord...Blythwood, Stansted, Essex . . . . .	Nov. 3, 1875	July 27, 1892
BOWEN, G. W. H....Ickleton Grange, Gt. Chesterford, Essex . . . . .	Nov. 2, 1892	Mar. 7, 1906
VP BOWEN-JONES, J. B....St. Mary's Court, Shrewsbury . . . . .	Mar. 6, 1867	Feb. 1, 1905
BRAND, Admiral the Hon. T. Seymour...Glynde, Lewes . . . . .	May 3, 1893	July 31, 1907
BRANSEY, Lord, G.C.B. Normanhurst Court, Battle . . . . .	July 2, 1879	June 5, 1907
BRASSEY, Henry Leonard C....Apthorpe Hall, Wansford, Northants. . . . .	—	Feb. 3, 1892
BRISCOE, W. A....Longstowe Hall, Cambridge . . . . .	—	Jan. 10, 1906
BROWNLOW, Earl...Belton House, Grantham . . . . .	Aug. 3, 1887	April 4, 1906
BUCHANAN, James...Graftham, Petworth . . . . .	—	July 27, 1904
BURGHCLERE, Lord...48 Charles Street, Berkeley Square, W. . . . .	—	Dec. 7, 1892
BURNS, Walter S. M....22 Old Broad Street, E.C. . . . .	—	April 4, 1906
BURTON, Lord, K.C.V.O....Rangemore, Burton-on-Trent . . . . .	Nov. 7, 1888	June 25, 1890

T Trustee.

VP Vice-President.

† Life Governor.

‡ Member of Council.

	Date of Election as Member	Date of Election as Governor
CADOGAN, Earl, K.G....Culford Hall, Bury St. Edmunds	—	Dec. 11, 1889
CALTHORPE, Lord...Elvetham, Winchfield	Nov. 7, 1883	May 2, 1894
CARRINGTON, Earl, K.G....Daws Hill, High Wycombe	—	Mar. 7, 1906
CATOR, John...Woodbastwick Hall, Norwich	—	May 1, 1907
P †CAVENDISH, Rt. Hon. Victor C.W., M.P....Holker Hall, Lancashire	—	Mar. 2, 1892
T †CAWDOR, Earl...Stackpole Court, Pembrokeshire	Mar. 3, 1863	Mar. 2, 1892
†CAWSTON, George...The Manor House, Cawston, Norfolk	—	June 6, 1894
VP CHAPLIN, Rt. Hon. Henry, M.P. ....Stafford House, S.W.	—	Nov. 2, 1870
CHELSEA, Viscount...48 Bryanston Square, W.	—	Feb. 6, 1895
CHETWYND, G. J. B....Wyndthorpe, near Doncaster	May 4, 1904	May 7, 1906
†CLARENDON, Earl of, G.C.B....The Grove, Watford	June 5, 1872	May 2, 1894
CLIFDEN, Viscount...Lanhydrock, Bodmin	July 13, 1883	Mar. 7, 1906
COBHAM, Viscount...Hagley Hall, Stourbridge	Dec. 8, 1875	April 4, 1906
COCKBURN, N. C....Harmston Hall, Lincoln	May 4, 1892	April 4, 1906
COLEBROOKE, Lord...Stratford House, Stratford Place, W.	—	May 2, 1906
COOPER, Sir Daniel, Bart...Warren Tower, Newmarket	Feb. 4, 1891	Jan. 10, 1906
COOPER, Sir George A., Bart...Hursley Park, Winchester	Feb. 4, 1903	May 1, 1907
COOPER, Sir Richard P., Bart...Shenstone Court, Lichfield	Dec. 12, 1888	Jan. 30, 1907
T COORNWALLIS, Fienes S. W....Linton Park, Maidstone	—	July 2, 1884
†COTTERELL, Sir John, Bart...Garnons, Hereford	May 6, 1896	Dec. 12, 1906
T †COVENTRY, Earl of...Croome Court, Severn Stoke, Worc.	April 1, 1863	April 4, 1894
†COX, Frederick...Harefield Place, Uxbridge	—	July 31, 1901
CRAVEN, Thomas...Kirklington Hall, Southwell, Notts.	May 6, 1891	Dec. 6, 1893
CREWE, Earl of...Crewe Hall, Crewe, Cheshire	Feb. 6, 1884	Mar. 7, 1894
VP †CRUTCHLEY, Percy...Sunninghill Lodge, Ascot	June 3, 1879	Feb. 1, 1905
CURTIS, Charles C....South Collingham, Newark, Notts.	Feb. 4, 1887	April 4, 1906
CURTIS-HAYWARD, Lt.-Col. J. F....Quedgeley House, Gloucester	Feb. 1, 1888	Dec. 12, 1906
DARTMOUTH, Earl of...Patehall Hall, Wolverhampton	—	Dec. 9, 1891
DAVIES, David, M.P....Plas Dinam, Llandinam, Mont.	June 1, 1904	Mar. 7, 1906
DEAN, W. M....30 Montagu Mansions, Baker Street, W.	—	July 31, 1907
DE LA RUE, Ernest...Lower Hare Park, Newmarket	—	April 4, 1906
T †DERBY, Earl of, K.G., G.C.B....Knowsley, Prescott	June 3, 1874	May 2, 1894
DE ROTHSCHILD, Alfred C....Halton, Tring	—	Mar. 7, 1906
DERWENT, Lord...Hackness Hall, Scarborough	—	April 7, 1869
DESBOROUGH, Lord...Taplow Court, Maidenhead	Dec. 12, 1888	Feb. 7, 1906
††DE TRAFFORD, Sir H. F., Bart...Hill Crest, Market Harborough	Aug. 1, 1883	June 1, 1892
†DEVONSHIRE, Duke of, K.G....Chatsworth, Chesterfield	—	June 2, 1880
†DICKSON-POYNDR, Sir J., Bart., M.P....Hartham Park, Corsham, Wilts.	Nov. 2, 1887	April 2, 1890
DIGBY, Lord...Minterne House, Cerne Abbas, Dorset	—	July 25, 1894
DORMER, John Cottrell...Cokethorpe, Witney, Oxon.	—	April 4, 1906
DOWNSHIRE, Marquis of...Easthampstead Park, Wokingham	—	Feb. 7, 1906
DUCIE, Earl of...Tortworth Court, Falfield, R.S.O., Glos.	May 5, 1869	Feb. 1, 1905
DUGDALE, James Broughton...Wroxall Abbey, Warwick	Feb. 3, 1892	June 28, 1905
VP DUGDALE, John Marshall...Llwyn, Llanfyllin, S.O., Mont.	Feb. 1, 1888	Feb. 1, 1905
†DULEEP-SINGH, Prince Frederick...Old Buckenham Hall, Attleborough	—	July 25, 1894
DUNCOMBE, Capt. W. H. O....Wareley Park, Sandy, Beds.	April 1, 1885	May 6, 1896
†DURHAM, Earl of...Lambton Castle, Durham	—	July 14, 1880
LEGERTON OF TATTON, Earl...Tatton Park, Knutsford	Mar. 6, 1872	Nov. 7, 1883
ELLESMERE, Earl of...Worsley Hall, Manchester	—	July 7, 1869
†EYFOT, Sir Charles, Bart...Beesthorpe Hall, Newark-on-Trent	—	May 2, 1906

Trustee

Vice-President

Life Governor

Member of Council

P President



*Royal Agricultural Society of England.*

ix

	Date of Election as Member	Date of Election as Governor
<b>ESKEL</b> , Earl of...9 Mansfield Street, W.	Nov. 7, 1888	Nov. 2, 1892
<b>EVANS</b> , Charles Lee...Norton Hill, Buncorn, Cheshire.	Feb. 2, 1881	May 1, 1907
<b>EVANS</b> , Lewis, F.S.A...Russells, Watford.	—	July 27, 1904
<b>EXETER</b> , Marquis of...Burghley House, Stamford.	May 4, 1898	June 21, 1898
<b>FARQUHAR</b> , Granville...24, Park Street, Grosvenor Square, W.	Feb. 6, 1889	April 4, 1906
<b>FARRAR</b> , Sidney Howard...2 King's Gardens, Hove.	—	Feb. 7, 1906
<b>VP FELLOWES</b> , Rt. Hon. Allwyn E...Honingham, Norwich.	Dec. 12, 1888	May 31, 1905
<b>VP FEVERSHAM</b> , Earl of...Duncombe Park, Helmsley, Yorks.	Mar. 5, 1862	Mar. 3, 1875
<b>FIFE</b> , Duke of, K.T...15 Portman Square, W.	—	Nov. 7, 1888
<b>FITZ HARDINGE</b> , Lord...Berkeley Castle, Glos.	Mar. 4, 1885	Feb. 1, 1905
<b>††FORREST</b> , Robert...St. Fagan's, Cardiff.	Feb. 6, 1878	May 30, 1906
<b>FOX</b> , J. St. V...Girsby Manor, Lincoln.	—	Feb. 7, 1906
<b>FURNESS</b> , Sir Christopher, M.P...Grantley Hall, Ripon.	—	Jan. 10, 1906
<b>GERARD</b> , Lord...Eastwell Park, Ashford, Kent.	April 13, 1904	Jan. 10, 1906
<b>GIBSON</b> , William...112 Regent Street, W.	—	Feb. 7, 1906
<b>T GILBEY</b> , Sir Walter, Bart...Elsenham Hall, Elsenham, Essex.	Nov. 2, 1870	June 5, 1889
<b>GLENESK</b> , Lord...139 Piccadilly, W.	—	Dec. 12, 1888
<b>GOLDSMID</b> , Oliver E. d'Avigdor...Somerhill, near Tonbridge.	—	Mar. 5, 1902
<b>GRAFTON</b> , Duke of, K.G...Wakefield Lodge, Stony Stratford.	—	June 3, 1884
<b>GRAY</b> , Harold S...Gog Magog Hills, Camba.	—	April 4, 1906
<b>††GREENALL</b> , Sir Gilbert, Bart...Walton Hall, Warrington.	Feb. 3, 1892	May 2, 1894
<b>GRIFFITHS</b> , John James...Highbury Grange, Highbury, N.	—	May 1, 1889
<b>GROVES</b> , James Grimble...Bank Hall, Chapel-en-le-Frith, Derbyshire.	—	May 1, 1895
<b>HADDINGTON</b> , Earl of, K.T...Tyninghame, Prestonkirk, N.B.	—	April 4, 1906
<b>HALL</b> , A. C...Six Mile Bottom, Cambridge.	June 6, 1894	Feb. 7, 1906
<b>HAMILTON AND BRANDON</b> , Duke of, Hamilton Palace, Hamilton, N.B.	—	Aug. 1, 1905
<b>HARDING</b> , Colonel T. Walter...Madingley Hall, Cambridge.	—	Feb. 7, 1906
<b>HAREWOOD</b> , Earl of...Harewood House, Leeds.	June 6, 1883	Nov. 2, 1892
<b>HASTINGS</b> , Lord...Melton Constable, Norfolk.	—	Dec. 11, 1907
<b>HAVERSHAM</b> , Lord...South Hill Park, Bracknell.	Dec. 12, 1888	April 4, 1906
<b>†HENDERSON</b> , Sir Alex., Bart...Buscot Park, Faringdon, Berks.	Nov. 5, 1890	July 28, 1897
<b>HENDERSON</b> , Capt. Harold G...Kitemore, Faringdon.	—	Mar. 7, 1906
<b>†HENRYSON-CAIRD</b> , James A...Cassencary, Creetown R.S.O., Kirkcudbright.	May 7, 1873	July 31, 1895
<b>HERTFORD</b> , Marquis of...Ragley Park, Alcester.	Aug. 2, 1882	May 7, 1884
<b>†HEYWOOD</b> , Sir Arthur Percival, Bart...Doveleys, Uttoxeter.	April 7, 1875	Feb. 2, 1898
<b>†HOLFORD</b> , Major George L., C.V.O., C.I.E...Westonbirt House, Tetbury, Glos.	—	April 6, 1892
<b>HOOLEY</b> , Terah F...Papworth Hall, near Cambridge.	—	Nov. 7, 1906
<b>†HORNSBY</b> , James...Laxton Park, Stamford.	June 6, 1878	May 29, 1895
<b>†HOTFIELD</b> , Lord...Hotfield Place, Ashford, Kent.	—	May 7, 1879
<b>HOWARD DE WALDEN</b> , Lord...Seaford House, Belgrave Square, S.W.	—	Mar. 7, 1906
<b>LOCHESTER</b> , Earl of...Melbury, Dorchester.	—	April 4, 1906
<b>INNES</b> , H. McLeod...Trinity College, Cambridge.	—	Mar. 7, 1906
<b>†LEWIN</b> , Colonel Thomas A...Lynehow, Carlisle.	May 5, 1880	June 25, 1895
<b>†LVEAGH</b> , Viscount, K.P...5 Grosvenor Place, S.W.	—	June 6, 1894

† Life Governor.

‡ Member of Council.

T Trustee.

VP Vice-President.

VOL. 68.

X

## List of Governors of the

	Date of election as Member	Date of election as Governor
JAMES, John Arthur...Coton House, Rugby	June 28, 1905	July 31, 1907
JAMES, William D....West Dean Park, Chichester	Nov. 7, 1894	Feb. 7, 1906
VP†JERSEY, Earl of, G.C.B., G.C.M.G....Middleton Park, Bicester	June 30, 1875	April 4, 1894
JOICEY, E....Blenkinsopp Hall, Haltwhistle, Northumberland	—	Dec. 12, 1888
†JONES, Walter J. H....Blakemere, Hartford, Cheshire	April 11, 1888	May 2, 1894
†JONES, William C....Llanerch Park, Trefnant, R.S.O.	—	May 30, 1906
†KINGSCOTE, Col. Sir Nigel, G.C.V.O., K.C.B....Kingscote, Wotton-under-Edge, Glos.	April 6, 1854	July 1, 1874
†KLEINWORT, Herman Greverns...Wierton Place, Boughton Monchelsea, Kent	—	June 4, 1902
§KOLHAPUR, H.H. The Raja of, G.C.S.I....Kolhapur, India	—	Feb. 6, 1889
†KYNNEBLESLEY, Thomas F....Leighton Hall, Ironbridge, Salop.	Nov. 7, 1883	Nov. 4, 1891
†LANSDOWNE, Marquis of, K.G., G.C.S.I....Bowood, Calne, Wilts.	Feb. 3, 1875	Feb. 5, 1896
LATHOM, Earl of...Lathom House, Ormskirk	—	Nov. 4, 1903
LAYCOCK, J. F....Wiseton, Bawtry, S.O., Yorks.	Nov. 2, 1887	May 2, 1906
†LECONFIELD, Lord...Petworth House, Sussex	—	Mar. 6, 1901
LEEDS, Duke of...Hornby Castle, Bedale	Nov. 6, 1901	Aug. 1, 1906
†LEICESTER, Earl of, K.G....Holkham Hall, Norfolk	—	Nov. 15, 1843
LICHFIELD, Earl of...Shugborough, Staffs (representing National Provincial Bank of England)	May 1, 1889	Aug. 1, 1906
†LLANGATTOCK, Lord...The Hendre, Monmouth	Mar. 1, 1871	May 2, 1894
LONDEBOROUGH, Earl of...Londesborough Park, Market Weighton	—	Nov. 7, 1906
†LONDONDERRY, Marquis of, K.G....Wynyard Park, Stockton-on-Tees	—	June 3, 1885
†LONG, Rt. Hon. Walter H., M.P....Rood Ashton, Trowbridge, Wilts.	Aug. 4, 1880	Dec. 11, 1895
†LONSDALE, Earl of...Lowther Castle, Penrith	—	July 4, 1883
LUCAS, Lord...Wrest Park, Ampthill, Beds.	—	Mar. 7, 1906
LUDLOW, Lord...27 Portland Place, W.	—	May 30, 1906
MACIVER, Colin...Blaisdon Hall, near Longhope, Glos.	April 6, 1881	Feb. 7, 1906
MAIR-RUMLEY, J. G....The Hammonds, Udmore, S.O., Sussex	June 5, 1901	Feb. 1, 1905
MALMESBURY, Earl of...Heron Court, Christchurch, Hants.	—	May 2, 1906
MANNERS, Lord...Avon Tyrrell, Christchurch, Hants.	Dec. 12, 1888	April 4, 1906
MANVERS, Earl...Thoresby Park, Ollerton, Notts.	Feb. 1, 1888	April 4, 1906
MEYER, Carl...Shortgrove, Newport, Essex	—	Feb. 7, 1906
†MIDDLETON, Lord...Birdsall House, York	—	Mar. 3, 1875
MIDWOOD, G. Norris...Brown Street, Salford	April 11, 1888	Mar. 5, 1902
MILDMAY, F. B., M.P....Flete, Ivy Bridge, Devon	—	Nov. 1, 1905
†MOORSOM-MITCHINSON-MAUDE, C. R....Harewood, Leeds	Dec. 2, 1857	July 26, 1893
†MORETON, Lord...Sarsden House, Chipping Norton, Oxon.	—	Mar. 3, 1875
†MOREWOOD, C. R. Palmer...Alreton Park, Derbyshire	April 7, 1875	Feb. 7, 1894
†MOUNT-EDGUMBE, Earl of, G.C.V.O...Mount-Edgumbe, Plymouth	Nov. 6, 1861	Mar. 5, 1899
MOUNTENEY-JEPHSON, A. J....Adbury Holt, Newbury, Berks.	—	Aug. 1, 1905
MUNCASTER, Lord...Muncaster Castle, Ravensglass, Cumberland	—	June 23, 1891
NEELD, Lt.-Col. Sir Audley D., Bart., C.B., M.V.O....Grittleton, Chippenham	—	July 31, 1901
NEWCASTLE, Duke of...Clumber, Worksoop	—	May 2, 1906
NORFOLK, Duke of, K.G....Arundel Castle, Sussex	—	July 29, 1891

§ Honorary Member.

T Trustee.

VP Vice-President.

† Life Governor.

	Date of election as Member	Date of election as Governor
IRON, Earl of...Somerley, Ringwood . . . . .	—	April 4, 1906
HEBROOK, Earl of...Stratton, Micheldever, Hants. . . . .	June 2, 1880	Feb. 1, 1905
HEBERLAND, Duke of. K.G....Alnwick Castle, North- land . . . . .	May 29, 1895	Feb. 27, 1907
7, Earl of, G.O.M.G....Clandon Park, Guildford, Surrey . . . . .	Nov. 3, 1880	May 27, 1903
1, Sir Walter, Bart....50 Grosvenor Square, W. . . . .	—	Feb. 1, 1899
AKER, Hon. Cecil T....Eccleston, Chester . . . . .	April 7, 1876	May 25, 1898
oger Charlton...Grappenhall Heyes, Warrington . . . . .	May 7, 1902	July 30, 1902
N, Sir Weetman D., Bart., M.P....Paddockhurst, Worth, X . . . . .	Nov. 6, 1895	Aug. 1, 1905
EB, Lord...Bank House, Wisbech . . . . .	May 7, 1894	Feb. 7, 1906
ENDA, Duke of...Palacio Liria, Madrid, Spain . . . . .	—	Feb. 7, 1906
B. W., M.P....11 Kensington Palace Gardens, W. . . . .	—	Mar. 7, 1906
S, Frederick S....Sunnyside, Holmwood, Surrey . . . . .	—	Mar. 7, 1906
S, Lionel...Tilney Hall, Winchfield, Hants. . . . .	—	June 28, 1905
PS, W. W. G....Berwick, Salop . . . . .	—	June 5, 1907
Col. Henry, C.B....Gorddinog, Llanfairfechan . . . . .	Mar. 5, 1862	Feb. 3, 1897
James E. . . . .	June 30, 1886	May 1, 1895
TH Earl of, C.B....Hewel Grange, Bromsgrove . . . . .	—	Nov. 6, 1878
ND, Duke of, K.G....Welbeck Abbey, Worksop . . . . .	—	June 2, 1880
AN, Viscount...Bryanston, Blandford . . . . .	Aug. 6, 1862	Mar. 5, 1890
OUTH, Earl of...Hurstbourne Park, Whitchurch, Hants. . . . .	—	Dec. 9, 1891
Earl of...Powis Castle, Welshpool . . . . .	April 6, 1887	June 23, 1891
Charles Lawrance...Grimblethorpe Hall, Lincoln . . . . .	—	July 31, 1907
R, Sir W. Cuthbert, Bart....Bawdsey Manor, Woodbridge, ik . . . . .	Mar. 3, 1886	April 7, 1897
R, Earl of...Longford Castle, Salisbury . . . . .	—	April 9, 1902
EN, Lt.-Col. W. J. F....Rogerthorpe Manor, Pontefract . . . . .	May 2, 1883	June 25, 1895
DALE, Lord, G.C.V.O....Batsford Park, Moreton-in-Marsh, . . . . .	—	Nov. 3, 1886
ames E....36 Cadogan Square, S.W. . . . .	Feb. 17, 1883	May 2, 1894
OND AND GORDON, Duke of, K.G....Goodwood, Chichester . . . . .	—	April 13, 1904
7, Viscount...10 Carlton House Terrace, S.W. . . . .	—	June 5, 1901
Marquis of, K.G....Studley Royal, Ripon. . . . .	—	July 3, 1861
8, D., M.P....53 Berkeley Square, W. . . . .	—	Jan. 10, 1906
ERY, Earl of, K.G....38 Berkeley Square, W. . . . .	—	June 6, 1894
CHILD, Lord, G.C.V.O....148 Piccadilly, W. . . . .	Nov. 7, 1888	June 4, 1890
CHILD, Leopold de...Ascott, Wing, Leighton Buzzard . . . . .	—	Mar. 1, 1893
CHILD, Hon. N. Charles...Ashton Wold, Oundle. . . . .	—	Jan. 10, 1906
CHILD, Hon. Walter...Tring Park, Tring . . . . .	—	Jan. 10, 1906
VD, Duke of...Belvoir Castle, Grantham . . . . .	Dec. 12, 1888	July 31, 1907
RY, Marquis of, C.B....Hatfield House, Herts. . . . .	Nov. 7, 1888	May 2, 1906
ONS, Leopold...Norbury Park, Dorking . . . . .	—	May 6, 1896
Y, George H....Fairholme, Marlborough Hill, Harrow . . . . .	Mar. 4, 1868	Dec. 10, 1902
YSON, W. J....East Field Hall, Warkworth . . . . .	—	Dec. 11, 1907
rd, K.C.V.O....Rufford Abbey, Ollerton, Notts. . . . .	May 4, 1898	Jan. 30, 1907

VP Vice-President.

\* Life Governor.

|| Member of Council.

	Date of election as Member	Date of election as Governor
†SCHRÖDER, Baron J. H. W....The Dell, Staines . . . . .	Nov. 3, 1869	April 2, 1890
SHAFTESBURY, Earl of, K.C.V.O....St. Giles' House, Salisbury . . . . .	May 6, 1903	May 1, 1907
SHEFFIELD, Sir Berkeley D. G., Bart., M.P....Normanby Park, Doncaster . . . . .	Feb. 7, 1900	Feb. 1, 1905
*SIMONDS, W. Barrow...Abbotts Barton, Winchester . . . . .	June 19, 1839	Mar. 5, 1890
†SLATER, Sam...Dunscar, Bolton-le-Moors, Lancs. . . . .	—	Feb. 7, 1906
SMITH, Eustace Abel...Longhills, Lincoln . . . . .	June 5, 1889	April 4, 1906
SMITH, G. Murray...Gumley Hall, Market Harborough . . . . .	Dec. 12, 1888	April 4, 1906
†SMITH, Hon. W. F. D., M.P....3 Grosvenor Place, S.W. . . . .	—	Dec. 9, 1891
T SPENCER, Earl, K.G....Althorp Park, Northampton . . . . .	Dec. 5, 1860	Mar. 3, 1875
††STANYFORTH, E. Wilfrid...Kirk Hammerton Hall, York . . . . .	Feb. 6, 1884	July 31, 1895
STRADBROKE, Earl of, C.B....Henham, Wangford . . . . .	Feb. 3, 1886	May 2, 1906
STRAUSS, E. A., M.P....Kingston House, Abingdon . . . . .	—	Mar. 7, 1906
SUFFOLK, Earl of...Charlton Park, Malmesbury . . . . .	—	May 2, 1906
SUTHERLAND, Duke of, K.G....Stafford House, St. James's, S.W. . . . .	Mar. 1, 1882	Dec. 7, 1892
†SUTTON, Martin J....Holme Park, Sonning, Berks. . . . .	May 1, 1878	Feb. 1, 1882
†SWINBURNE, Sir John, Bart....Capheaton, Newcastle-on-Tyne . . . . .	May 1, 1867	May 7, 1896
SWITHINBANK, Harold...Denham Court, Denham, Bucks. . . . .	Feb. 4, 1885	Mar. 7, 1901
†TABLETON, Lieut. Alfred H., M.V.O., R.N....Breakspears, Uxbridge . . . . .	—	July 29, 1906
†THOMPSON, Henry Yates...19 Portman Square, W. . . . .	—	Nov. 7, 1896
T†THOROLD, Sir John H., Bart....Syston Park, Grantham . . . . .	Aug. 5, 1868	May 1, 1881
TOLLEMACHE, Lord...Peckforton Castle, Tarporley . . . . .	—	Mar. 7, 1919
TOWNLEY, Rev. Charles F....Fulbourn Manor, Cambridge . . . . .	Mar. 7, 1894	Feb. 7, 1919
TREDEGAR, Viscount...Tredegar Park, Newport, Mon. . . . .	—	May 3, 1881
†TRENCH, Col. The Hon. Wm. Le Poer...3 Hyde Park Gardens, W. . . . .	Dec. 12, 1888	May 1, 1919
TURBERVILL, Col. J. P....Ewenny Priory, Bridgend . . . . .	Mar. 5, 1884	July 27, 1881
†TWEEDMOUTH, Lord...Guisachan, Beaulieu, N.B. . . . .	—	July 31, 1881
VAN DE WEYER, Col. V. W. B....New Lodge, Windsor Forest . . . . .	Aug. 1, 1888	Jan. 10, 1919
†VIVIAN, H. H....Tregavethan, near Truro . . . . .	Nov. 1, 1876	May 1, 1881
WALTER, Col. Arthur F....Bearwood, Wokingham . . . . .	—	Mar. 6, 1881
†WARREN, Reginald A....Preston Place, East Preston, Worthing . . . . .	June 3, 1857	June 6, 1881
WATSON, Rev. Wentworth...Rockingham Castle, Uppingham . . . . .	—	May 2, 1881
WERNHER, Sir Julius, Bart....82 Piccadilly, W. . . . .	—	April 13, 1881
WESTMINSTER, Duke of, G.C.V.O....Eaton Hall, Chester . . . . .	—	May 30, 1881
†WHABNCLIFFE, Earl of...Wortley Hall, Sheffield . . . . .	—	May 2, 1881
WHITEHEAD, Sam...Southill, Biggleswade, Beds. . . . .	June 3, 1879	Mar. 7, 1881
†WHITEHEAD, Sir Charles...Barming House, Maidstone . . . . .	April 1, 1857	Feb. 6, 1881
†WILLIAMS, Henry...Moor Park, Harrogate . . . . .	Aug. 1, 1883	Mar. 6, 1881
WILLIAMS, Joseph G....Pendley Manor, Tring . . . . .	—	Jan. 10, 1881
†WILSON, Darcy Bruce...Sencroft Hall, near Leeds . . . . .	June 3, 1891	Feb. 1, 1881
WILSON, H. Rimington...Blyborough Hall, Kirton-in-Lindsey . . . . .	June 5, 1907	July 31, 1881
WOLVERTON, Lord...26, St. James's Place, S.W. . . . .	—	May 2, 1881
WYNN, Hon. F. G....Glynllivon Park, Carnarvon . . . . .	Mar. 4, 1891	Nov. 4, 1881
WYTHES, Ernest J....Copped Hall, Epping, Essex . . . . .	April 12, 1893	July 29, 1881
VPYARBOROUGH, Earl of...Brocklesby Park, Lincolnshire . . . . .	Aug. 4, 1880	April 4, 1881
†YEBBURGH, Robert A....Woodfold Park, Blackburn . . . . .	—	Nov. 7, 1881
†ZETLAND, Marquis of, K.T....Aske Hall, Richmond, Yorks. . . . .	Feb. 4, 1874	May 2, 1881

†P Vice-President.

T Trustee.

\* Elected a Foundation Life Governor, March 2, 1890.

† Life Governor.

HONORARY MEMBERS OF THE SOCIETY.

(“British Subjects or Foreigners who have rendered exceptional services to Agriculture or Allied Sciences,” and who have been elected under By-law 8 as Honorary Members, without payment of subscription.)

	Date of election
ARISUGAWA, H.I.H. Prince...Tokio, Japan	June 29, 1905
ARNIM, Berndt von...Ortewen, Brandenburg, Germany	June 21, 1899
BANG, Dr. B....Professor at the Royal Veterinary College, Copenhagen.	July 31, 1901
CHARTUYVELS-VAN-DER-LINDEN, Jules, M.A....215 Rue de la Loi, Brussels	Dec. 11, 1895
CHAUVEAU, Prof. Auguste, M.D., LL.D....10 Avenue Jules Janin, Passy, Paris.	Dec. 6, 1893
CLARKE, Sir Ernest, M.A., F.S.A.... 31 Tavistock Square, London, W.C.	Dec. 6, 1905
DE VOGÜE, Marquis...2 Rue Fabert, Paris (Ordinary Member, June 1, 1892)	June 21, 1899
ELLIOTT, Sir Thomas H., K.C.B...Secretary, Board of Agriculture, 4 Whitehall Place	June 23, 1903
ETZDORF, Landrath von...Elbing, West Prussia	May 30, 1900
EWART, Prof. James Cossar, M.D., F.R.S. ...Regius Professor of Natural History at the University of Edinburgh.	May 1, 1901
FLEISCHMANN, Prof. Wm....Director of the Agricultural Institute of the Royal University of Königsberg	Dec. 12, 1894
KOLHAPUR, H.H. The Raja of, G.C.S.I....Kolhapur (Governor, Feb. 6, 1889)	July 7, 1902
LE COCQ, Señor Alfredo Carlos...Director of the Department of Agriculture, Lisbon	June 23, 1903
LIVINGE, Prof. G. D., M.A., F.R.S....The University, Cambridge	Mar. 7, 1894
LOVINK, Herr Hermanus Johannus...Director-General of Agriculture, The Hague, Holland	April 13, 1904
MACDONALD, James, F.R.S.E....Secretary of the Highland and Agricultural Society of Scotland, 3 George IV. Bridge, Edinburgh	June 23, 1903
MOFADYEAN, Prof. Sir John, M.B., B.Sc., C.M....Royal Veterinary College, Camden Town, N.W. (Ordinary Member, Feb. 1, 1893)	May 1, 1901
NOBBE, Dr. J. O. F....Director of the Experimental Station, Tharand, Saxony	May 6, 1896
PASSY, Louis...45 Rue de Clichy, Paris	June 23, 1891
PLUNKETT, The Rt. Hon. Sir Horace Curzon, K.C.V.O., F.R.S....Vice-President of the Irish Department of Agriculture and Technical Instruction, Dublin	June 23, 1903
PROSKOWETZ, Emanuel Ritter von, sen....Kwassitz, Moravia	Nov. 5, 1890
RAMOS-MEXIA, Señor Don Ezequiel ...Sociedad Rural Argentina, Buenos Aires	July 30, 1902
REID, His Excellency the Hon. Whitelaw...Dorchester House, Park Lane, W.	June 29, 1905
SALMON, Dr. D. E....Chief of the Bureau of Animal Industry, United States Department of Agriculture, Washington	July 31, 1901
SCHERBATOFF, Prince Alexander...President of the Imperial Agricultural Society of Moscow, Russia	Nov. 3, 1897
SIEMONI, Dr. Giovanni Carlo...Director-General of the Department of Agriculture, Rome	June 23, 1903
THIEL, Dr. H....Privy Councillor, and Director of the Department of Agriculture, 17 Lutherstrasse, Berlin	Aug. 1, 1883
TISSERAND, Eugène...Ancien Directeur de l'Agriculture, 17 Rue du Cirque, Paris	Aug. 1, 1883
VASSILLIÈRE, Léon...Director of Agriculture at the Ministry of Agriculture, Paris	June 23, 1903

SUMMARY OF MEMBERS ON REGISTER, DECEMBER 31, 1907.

- 1 Foundation Life Governor (Member elected before the granting of the Charter on March 26, 1840).
  - 174 Governors paying an annual subscription of 5l.
  - 90 Life Governors who have compounded for their annual subscriptions.
  - 6,299 Members paying an annual subscription of 1l.
  - 3,076 Life Members who have compounded for their annual subscriptions.
  - 29 Honorary Members.
- 9,669 Total number of Governors and Members at December 31, 1907.

# Royal Agricultural Society of England.

## LIFE GOVERNORS AND MEMBERS PAYING AN ANNUAL SUBSCRIPTION TO THE SOCIETY'S FUNDS.

	£	s.	d.		£	s.	d.
Sir Oswald Mosley, Bart.	25	0	0	Mr. Peter Iredale	1	1	0
Sir Berkeley G. D. Sheffield, Bt.	25	0	0	Mr. J. W. Kenyon	1	1	0
Earl Cawdor	10	0	0	Mr. O. O. Openshaw	1	1	0
Lord Leconfield	10	0	0	Mr. Ralph Palmer	1	1	0
Mr. R. A. Warren	5	5	0	Mr. W. Fillingham Parr	1	1	0
Col. Sir Nigel Kingscote, G.C.V.O., K.C.B.	5	0	0	Mr. E. E. Pearson	1	1	0
Earl of Mount-Edgcumbe	5	0	0	Mr. W. A. Prout	1	1	0
Sir J. H. Thorold, Bart.	5	0	0	Mr. J. E. Rawlence	1	1	0
Mr. A. H. Leslie-Melville	3	3	0	Mr. R. J. Sankey	1	1	0
Lord Moreton	3	3	0	Mr. Michael Stocks	1	1	0
Mr. T. Brocklebank	2	2	0	Mr. Arthur L. Stride	1	1	0
Mr. A. E. W. Darby	2	2	0	Mr. Walter C. Stunt	1	1	0
Mr. John Howard Howard	2	2	0	Mr. Garrett Taylor	1	1	0
Lord Magheramorne	2	2	0	Mr. George Taylor	1	1	0
Mr. Ernest Mathews	2	2	0	Mr. John Thornton	1	1	0
Sir Charles Morrison-Bell, Bart.	2	2	0	Mr. T. L. Walker	1	1	0
Lord Northbourne	2	2	0	Mr. Conrad A. Wallroth	1	1	0
Mr. R. H. Oter	2	2	0	Mr. Thomas E. Yorke	1	1	0
Mr. E. W. Stanyforth	2	2	0	Mr. Lawrence Abram	1	0	0
Lord Allendale	2	0	0	Mr. Joseph Ashforth	1	0	0
Mr. W. H. Cooke	2	0	0	Mr. Robert H. Ashton	1	0	0
Mr. Percy Crutchley	2	0	0	Col. C. T. Caldecott	1	0	0
Mr. J. B. Kingscote	2	0	0	Mr. W. T. Cotes	1	0	0
Lt.-Col. F. W. Lambton	2	0	0	Major P. G. Craigie	1	0	0
Mr. Charles Lethbridge	2	0	0	Mr. J. F. K. Cross	1	0	0
Sir J. F. Rotton, K.C.	2	0	0	Mr. Wm. Marshall Dugdale	1	0	0
Mr. S. G. Stopford Sackville	2	0	0	Mr. Bernard Dyer	1	0	0
Lord Wenlock	2	0	0	Mr. Charles A. Ferard	1	0	0
Mr. E. V. V. Wheeler	2	0	0	Mr. T. F. Filgate	1	0	0
Hon. Percy Wyndham	2	0	0	Sir Wm. Foster, Bart.	1	0	0
Mr. Richard Bayly	1	1	0	Mr. William Garnett	1	0	0
Mr. Thomas Brigg	1	1	0	Mr. J. Francis Gaskell	1	0	0
Mr. G. J. M. Burnett	1	1	0	Mr. J. J. Harle	1	0	0
Mr. A. J. Butcher	1	1	0	Mr. J. Smith Hill	1	0	0
Capt. H. A. Cartwright	1	1	0	Mr. W. Hollins	1	0	0
Mr. G. E. Champion	1	1	0	Mr. W. W. Jeurwine	1	0	0
Rear-Admiral W. R. Clutterbuck	1	1	0	Capt. Hon. F. Johnstone	1	0	0
Col. R. B. Colvin	1	1	0	Mr. J. R. H. Keyworth	1	0	0
Mr. George Crawhall	1	1	0	Mr. J. W. Kimber	1	0	0
Mr. J. L. Cross	1	1	0	Mr. Gervase Markham	1	0	0
Mr. William G. Crum	1	1	0	Mr. Henry Mellish	1	0	0
Mr. T. A. Dickson	1	1	0	Captain Devereux H. Mytton	1	0	0
Mr. James Dungey	1	1	0	Hon. A. E. Parker	1	0	0
Mr. Edwin H. Everett	1	1	0	Mr. Edmund Potter	1	0	0
Mr. W. H. B. Fletcher	1	1	0	Lieut.-Col. W. J. F. Ramsden	1	0	0
Mr. T. Musgrave Francis	1	1	0	Mr. Frederick Reynard	1	0	0
Sir William Grantham	1	1	0	Mr. John Roynon	1	0	0
Mr. W. T. Hall	1	1	0	Mr. Alfred Smetnam	1	0	0
Sir E. S. Hardinge, Bart.	1	1	0	Mr. T. Carrington Smith	1	0	0
Viscount Hill	1	1	0	Mr. Richard H. Tidswell	1	0	0
Mr. E. W. Hussey	1	1	0	Mr. Arthur P. Turner	1	0	0
Mr. W. F. Ingram	1	1	0	Mr. E. W. Voelcker	1	0	0
				Mr. Jonas M. Webb	1	0	0
				Earl of Westmorland	1	0	0

£210 9

TABLE SHOWING THE NUMBER OF GOVERNORS AND MEMBERS  
IN EACH YEAR FROM THE ESTABLISHMENT OF THE SOCIETY.

Year ending with Show of	President of the Year	Governors		Members			Total.
		Life	Annual	Life	Annual	Honor-ary	
1839	3rd Earl Spencer	—	—	—	—	—	1,100
1840	5th Duke of Richmond	86	189	146	2,434	5	2,860
1841	Mr. Philip Pusey	91	219	231	4,047	7	4,595
1842	Mr. Henry Handley	101	211	328	5,194	15	5,849
1843	4th Earl of Hardwicke	94	209	429	6,155	15	6,902
1844	3rd Earl Spencer	95	214	442	6,161	15	6,927
1845	5th Duke of Richmond	94	198	527	5,899	15	6,733
1846	1st Viscount Portman	92	201	554	6,105	19	6,971
1847	6th Earl of Egmont	91	195	607	5,478	20	6,391
1848	2nd Earl of Yarborough.	93	186	648	5,387	21	6,335
1849	3rd Earl of Chichester	89	178	582	4,643	20	5,512
1850	4th Marquis of Downshire	90	169	627	4,356	19	5,261
1851	5th Duke of Richmond	91	162	674	4,175	19	5,121
1852	2nd Earl of Ducie	93	156	711	4,002	19	4,981
1853	2nd Lord Ashburton	90	147	730	3,928	19	4,923
1854	Mr. Philip Pusey	88	146	771	4,152	20	5,177
1855	Mr. William Miles, M.P.	89	141	795	3,838	19	4,882
1856	1st Viscount Portman	85	139	839	3,896	20	4,979
1857	Viscount Ossington	83	137	896	3,933	19	5,068
1858	6th Lord Berners	81	133	904	4,010	18	5,146
1859	7th Duke of Marlborough	78	130	927	4,008	18	5,161
1860	5th Lord Walsingham	72	119	927	4,047	18	5,183
1861	4th Earl of Powis	84	90	1,113	3,328	18	4,633
1862	H.R.H. The Prince Consort 1st Viscount Portman	83	97	1,151	3,475	17	4,823
1863	Viscount Eversley	80	88	1,263	3,735	17	5,183
1864	2nd Lord Feversham	78	45	1,343	4,013	17	5,496
1865	Sir E. C. Kerrison, Bart., M.P.	79	81	1,386	4,190	16	5,752
1866	1st Lord Tredegar	79	84	1,395	4,049	15	5,622
1867	Mr. H. S. Thompson	77	82	1,388	3,903	15	5,465
1868	6th Duke of Richmond	75	74	1,409	3,888	15	5,461
1869	H.R.H. The Prince of Wales, K.G.	75	73	1,417	3,864	17	5,446
1870	7th Duke of Devonshire.	74	74	1,511	3,764	15	5,438
1871	6th Lord Vernon	72	74	1,589	3,896	17	5,648
1872	Sir W. W. Wynn, Bart., M.P.	71	73	1,655	3,953	14	5,766
1873	Earl Cathcart	74	62	1,832	3,936	12	5,916
1874	Mr. Edward Holland	76	58	1,944	3,756	12	5,846
1875	Viscount Bridport	79	79	2,058	3,918	11	6,145
1876	2nd Lord Chesham	83	78	2,164	4,013	11	6,349
1877	Lord Skelmersdale	81	76	2,239	4,073	17	6,486
1878	Col. Kingscote, C.B., M.P.	81	72	2,328	4,130	26	6,637
1879	H.R.H. The Prince of Wales, K.G.	81	72	2,453	4,700	26	7,332
1880	9th Duke of Bedford	83	70	2,673	5,083	20	7,929
1881	Mr. William Wells	85	69	2,765	5,041	19	7,979
1882	Mr. John Dent	82	71	2,849	5,059	19	8,080
1883	6th Duke of Richmond and Gordon	78	71	2,979	4,952	19	8,099
1884	Sir Brandreth Gibbs	72	72	3,203	5,408	21	8,776
1885	Sir M. Lopes, Bart., M.P.	71	69	3,356	5,619	20	9,135
1886	H.R.H. The Prince of Wales, K.G.	70	61	3,414	5,569	20	9,134
1887	Lord Egerton of Tatton	71	64	3,440	5,387	20	8,982
1888	Sir M. W. Ridley, Bart., M.P.	66	56	3,521	5,225	16	8,884
1889	HER MAJESTY QUEEN VICTORIA	73	58	3,567	7,153	15	10,866
1890	Lord Moreton	122	58	3,846	6,941	17	10,984
1891	2nd Earl of Ravensworth	117	60	3,811	6,921	19	10,928
1892	Earl of Feversham	111	69	3,784	7,066	20	11,050
1893	1st Duke of Westminster, K.G.	107	74	3,786	7,138	21	11,126
1894	Duke of Devonshire, K.G.	113	73	3,798	7,212	22	11,218
1895	Sir J. H. Thorold, Bart.	120	80	3,747	7,179	23	11,149
1896	Sir Walter Gilbey, Bart.	126	83	3,695	7,253	23	11,180
1897	H.R.H. The Duke of York, K.G.	126	83	3,705	7,285	24	11,223
1898	Earl Spencer, K.G.	121	79	3,687	7,182	25	11,094
1899	Earl of Coventry	116	75	3,656	7,009	23	10,879
1900	H.R.H. The Prince of Wales, K.G.	111	71	3,628	6,832	24	10,666
1901	Earl Cawdor	102	70	3,564	6,338	27	10,033
1902	H.R.H. Prince Christian, K.G.	100	69	3,500	5,955	26	9,650
1903	H.R.H. The Prince of Wales, K.G.	99	62	3,439	5,771	27	9,398
1904	Earl of Derby, K.G.	96	68	3,375	5,906	32	9,477
1905	Lord Middleton	95	72	3,270	5,808	31	9,276
1906	Mr. F. S. W. Cornwallis.	94	155	3,132	6,189	30	9,600
1907	Earl of Yarborough	91	174	3,076	6,299	29	9,689

**STATEMENT made to the Council by the Chairman  
of the Finance Committee, on presenting the  
Accounts for the year 1907.**

MR. ADEANE said that as the Accounts were to a very great extent a test of the prosperity of the Society, he was glad to be able to submit so favourable a statement. He thought it proved that the efforts of the Council during the last two and a half years to put the Society back into a prosperous condition had been successful. It would be remembered that there was a deficit in 1906 of 1,281*l.*. The estimated credit balance for last year was 347*l.*; the actual balance was 431*l.*. On the side of expenditure, under the heading of General Administration, there had been a large reduction, which would have been much greater had they not had to meet several extraordinary charges. Under the heading of Rent, Rates, Taxes, &c., they had had to pay 223*l.* to cover the expense of the storage of furniture, Surveyor's fees, and other expenses connected with the removal from Harewood House to 16, Bedford Square. The completion of the Council Chamber at a cost of 146*l.* had been paid for out of the Ordinary Account. Owing to the delay in the sale of Harewood House they had to pay four months' interest on the debentures, which came to 221*l.*, in addition to 116*l.* interest on loans, making a total extraordinary expenditure of 706*l.*. The total expenditure for 1907 was 7,867*l.*. On the Income side it was satisfactory that the Subscriptions showed an increase for the year of 333*l.*, the Interest on Daily Balances an increase of 318*l.*, and they had an increase under the head of Income from Investments of 108*l.*, giving a total increased income from the sources mentioned of 759*l.*, and a total income of 8,298*l.*. That gave a credit balance of 431*l.*, and he believed he was correct in saying that this was the first time since the year 1892 that they had been able to show a credit balance on the ordinary account, if they ignored the practice adopted since the year 1890 of debiting the capital account with the cost of Life Members at fifteen shillings each, and crediting the ordinary account with the same amount. Referring to the balance-sheet, it would be observed on the credit side that their Reserve now stood at 21,795*l.*, as compared with 7,610*l.* in 1906. In addition, they held the lease of 16, Bedford Square, valued at 2,900*l.*, and they proposed to write off that amount at the rate of 100*l.* a year. The item under the heading of fixtures had been written off to the extent of 1,422*l.*, as the greater amount of the fixtures in Harewood House had been sold with the property. Now that they were in a position to make themselves absolutely secure, they thought it wise to write off more as depreciation of the Show plant, and they had raised it from 5 to 10 per cent., and they had raised the depreciation on the furniture from 7½ to 10 per cent. On the debit side of the balance-sheet they would see that there had been in the course of last year very considerable additions to their capital. The profit on the sale of Harewood House came to 5,473*l.*, after paying off the debentures which were secured on the property; they made a profit on the sale of Park Royal of 5,726*l.*, and they had an addition, in the shape of the Harewood House Sinking Fund, of 3,430*l.*. He might explain that that fund had been formed by friends of the Society to pay off the debentures which had been issued when Harewood House was purchased, and when they sold the property and the debentures were paid off, there being no further necessity for the fund, the Trustees handed that amount over to the Society. They also had the very large balance of 7,056*l.* from the Show account. The total result of these additions was to increase the capital of the Society during the past year from 7,045*l.* to 29,267*l.*, a net increase of 22,222*l.*. The Auditors considered that certain funds which the Society held in trust should not be included in the balance-sheet, but should be shown separately, as they could not be regarded as assets of the Society.

**FORECAST OF ORDINARY RECEIPTS AND EXPENDITURE FOR 1908.**  
(Other than in respect of the Show.)

Actual Figures for 1907.	Receipts.	£
7,362	From subscriptions for 1908 of Governors and Members ... ..	7,350
546	From Interest on Daily Balances ... ..	150
134	From Interest on Investments ... ..	600
256	From Sales of Text Book, Pamphlets, &c. (This does not include the sales of Journals, which are deducted from the cost of production) ... ..	200
1298		8,300



<i>Expenditure.</i>		£
1,514	Salary of Secretary and Official Staff ... ..	1,514
40	Pension to Official pensioned in 1888 ... ..	40
974	Rent, Lighting, Cleaning, Wages, &c. (say) ... ..	700
147	Completion of Council Room.	
351	Printing and Stationery ... ..	350
160	Postage, Telegrams, Carriage, &c. ....	160
456	Miscellaneous ... ..	300
567	Journal ... ..	600
613	Chemical Department... ..	600
250	Botanical Department... ..	280
200	Zoological Department ... ..	200
202	Veterinary Department ... ..	200
171	Examinations for National Diploma (R.A.S.E. Share) ... ..	200
222	Four months' interest on Harewood House Debenture Stock (February to April).	
431	Credit Balance.	
6,298		5,124
2,000	Contribution from Governors' and Members' Subscriptions to the expenses of the Annual Show ... ..	2,500
8,298		7,624
	Estimated Receipts ... ..	8,300
	Estimated Expenditure ... ..	7,624
	Estimated Receipts over Expenditure ... ..	676

Coming to the estimates of receipts and expenditure for the coming year, they estimated that from subscriptions they would receive 7,350*l.*, from interest on Daily Balances 150*l.*, from interest on Investments 600*l.*, from sales of Text Book, Pamphlets, &c., 200*l.*; making their total estimated receipts 8,300*l.* The total expenditure they estimated would be 7,624*l.* after allowing for a contribution to the Show Account of 2,500*l.* He might say with regard to the raising of that amount that the Special Committee which reported on the affairs of the Society some two years ago recommended that they should put 2,000*l.* from the Ordinary Account to the Show Fund. That was when the contribution to the Prize Fund was only 4,000*l.* It would be remembered that the Council had been asked—and had consented—to increase this contribution to 5,000*l.* for the present year, and they had thought it better to make themselves quite secure by increasing the contribution to the Show Fund by an additional 500*l.* Their total estimated receipts were 8,300*l.*, and their estimated expenditure 7,624*l.*, giving an estimated balance of 676*l.* over expenditure in 1908. To summarise their position: They had in the year 1907 by the sale of their properties, discharged all their liabilities, and they had added to the Reserve Fund 14,184*l.* The Society was also relieved of the very great cost of maintaining those properties with which they had parted, and he might say that on rent alone for the current year, as compared with the year 1906, there would be a saving of no less a sum than 1,087*l.* He thought that their expenditure for 1908 might be considered normal, and if their income remained the same as at present, they would be able to show a fair balance in future on the Ordinary Account. The reserve, which he was glad to say now stood at 21,795*l.*, had been largely built up out of the profit derived from the sale of their different properties. In future they could only look to the profits of the Show Account and any balance they might have on the Ordinary Account for additions to that fund. He thought it would be generally agreed that it was very desirable that they should have a large Reserve Fund to provide against possible losses on future Shows, to meet any liabilities on account of the very large amount of life compositions, and to enable the Society in future to go into purely agricultural parts of England, which were of necessity less populous, and therefore probably less profitable from the point of view of "gate." He was sure that if they pursued the policy of economy they would be able to keep up the Society in a thoroughly efficient manner, and put it in the near future into an impregnable position of independence, thereby relieving themselves for ever from those financial cares which had been their chief trouble in the past.

February 26, 1908.

Dr.

BALANCE-SHEET,

Corresponding figures for 1906.		£ s. d.	£ s. d.	£ s. d.
	To SUNDRY CREDITORS—			
£	Sundry Creditors and outstanding . . . . .		1,198 12 8	
1,909	Subscriptions received in 1907 in advance . . . . .		65 2 0	
110	Show Receipts received in 1907 and belonging to 1908 . . . . .		<u>1,932 13 11</u>	
848				3,194 8 7
<u>2,867</u>				
7,785	<i>Loan</i>			
3,000	<i>Loan</i>			
	To CAPITAL—			
2,628	As at December 31, 1906 . . . . .		7,045 4 5	
—	Profit on Sale of Harewood House . . . . .		5,473 5 5	
—	Permanent Site Fund as at December 31, 1906 . . . . .	27,557 7 0		
—	Less Loss on Realisation of Shares in Park Royal, Ltd. . . . .	<u>21,830 15 9</u>	<u>5,726 11 3</u>	
	BALANCE FROM SHOW FUND—			
2,028	Profit on Show at Lincoln . . . . .	5,056 0 10		
2,000	Contribution from Ordinary Income . . . . .	<u>2,030 0 0</u>	7,056 0 10	
824	Life Compositions received in 1907 . . . . .		579 0 0	
1,038	Donations towards the Society's Funds . . . . .		23 1 0	
219	Harewood House Sinking Fund with accumulated interest . . . . .		<u>3,430 15 2</u>	
—	Credit Balance on Ordinary Income and Expenditure Account . . . . .		<u>431 3 9</u>	
<u>8,737</u>			<u>29,765 1 10</u>	
1,281				
<u>7,456</u>				
	DEPRECIATIONS written off, viz. :—			
	Fixtures . . . . .	25 5 2		
	Furniture . . . . .	213 1 8		
	Machinery . . . . .	12 2 6		
	Show Plant . . . . .	197 10 10		
	Buildings at Woburn . . . . .	<u>50 0 0</u>	<u>488 0 2</u>	
411				29,267 1 8
<u>7,045</u>				

[Note.—For investments other than those shown in this Balance-sheet see Statement of Funds held in Trust, &c., page xxii.]

£20,697

£32,461 10 3

THOMAS MOROW, *Secretary.*WELTON, JONES & CO., *Accountants.*

**SOCIETY OF ENGLAND.**

xi:

**DECEMBER 31, 1907.**

*Cr.*

Corresponding figures for 1906.	£		£ s. d.	£ s. d.
		By Reserve Fund 16,897l. 18s. 7d. Consols. at cost (average cost 83½)	14,000 0 0	
7,610		Balance at Bank to be invested	7,794 19 7	21,794 19 7
1,145		<i>H. H. Stock</i>		
		By LEASE OF 16 BEDFORD SQUARE	3,000 0 0	
3,000		Less Amount written off	100 0 0	2,900 0 0
		By FIXTURES—		
		Value at December 31, 1906	1,759 13 10	
		Less Amount included in sale of Harewood House	1,422 18 10	
			336 15 0	
		Less Depreciation at 7½ per cent.	25 5 2	
			311 9 10	
1,760		Added during 1907	168 15 0	480 4 10
		By FURNITURE—		
		Value at December 31, 1906	2,184 16 8	
		Less Sales	54 0 0	
			2,130 16 8	
		Less Depreciation at 10 per cent.	213 1 8	
			1,917 15 0	
2,185		Additions during 1907	52 7 8	1,970 2 8
1,500		By PICTURES (500l.) and BOOKS (1,000l.)		1,500 0 0
		By MACHINERY—		
		Value at December 31, 1906	127 5 8	
127		Less Depreciation at 10 per cent.	12 2 6	115 3 2
		By SHOW PLANT—		
		Value at December 31, 1906	1,975 8 10	
		Less Depreciation at 10 per cent.	197 10 10	
			1,777 18 0	
1,975		Added during 1907	11 3 0	1,789 1 0
		By BUILDINGS FOR POT EXPERIMENTS AT WOBURN—		
		As per Account at December 31, 1906	650 0 0	
650		Less Depreciation.	50 0 0	600 0 0
435		By SUNDRY DEBTORS		478 16 8
		By CASH AT BANKERS AND IN HAND—		
		Ordinary Account	768 4 7	
249		In Hand	64 17 9	
61				833 2 4
£20,697				£32,461 10 3

Examined, audited, and found correct, this 10th day of February, 1908.

JONAS M. WEBB,  
HUBERT J. GREENWOOD, } *Auditors on behalf of the Society.*  
NEWELL P. SQUAREY,

## STATEMENT OF ORDINARY INCOME

The Expenditure in this account includes not only cash payments.

Corresponding figures for 1906.

## Income.

£	ANNUAL SUBSCRIPTIONS:—	£ s. d.	£ s. d.
711	<i>Governors</i> : Subscriptions for 1907 . . . . .	798 10 0	
70	<i>Members</i> : Received in 1906, but belonging to 1907 . . . . .	110 2 0	
5,748	Subscriptions for 1907 . . . . .	6,007 0 0	
179	Subscriptions for 1907 (additional) . . . . .	167 5 6	
71	Subscriptions for previous years . . . . .	75 1 0	
	<b>LIFE GOVERNORS AND MEMBERS:—</b>		
250	Annual Contributions . . . . .	204 7 0	
7,029	<b>MISCELLANEOUS:—</b>		7,342 5 6
228	Interest on Daily Balances . . . . .	545 19 1	
26	Income on Investments . . . . .	134 1 1	
77	Sales of Pamphlets, Diagrams, &c. . . . .	76 5 0	
138	Sales of Text Book . . . . .	161 5 3	
20	Letting of Council and Committee Rooms . . . . .	18 18 0	
			936 8 5
489	Rent of 12 Hanover Square . . . . .	313 10 0	
	<i>Less</i> Rent paid . . . . .	313 10 0	

7,518

1,281

8,799£8,298 13 11

THOMAS MCBROW, *Secretary*.  
WELTON, JONES & CO., *Accountants*.

# AND EXPENDITURE FOR THE YEAR 1907.

xxi

but all liabilities in connection with the year's transactions.

Corresponding figures for 1908.

£	Expenditure.		£ s. d.	£ s. d.
	<b>GENERAL ADMINISTRATION:—</b>			
1,779	Salaries of Official Staff . . . . .	1,514	0 0	
190	Pensions to Officials . . . . .	40	0 0	
57	Professional Charges:—Auditors' Fees, &c. . . . .	112	2 6	
1,787	Rent, Rates, Taxes, Insurance, and House Expenses . . . . .	974	6 9	
—	Completion of Council Chamber . . . . .	146	15 6	
15	Four Months' Interest on Harwood House Debenture Stock . . . . .	221	18 4	
403	Binding and Purchase of Books . . . . .	4	13 6	
187	Printing and Stationery . . . . .	350	18 9	
35	Postage and Telegrams . . . . .	159	16 4	
61	Carriage of Parcels and Travelling Expenses . . . . .	59	5 3	
323	Advertising and Miscellaneous Office Expenses . . . . .	66	1 2	
4,837	Interest on Loan . . . . .	110	8 5	
				3,763 4 6
	<b>JOURNAL OF THE SOCIETY, VOL. 68:—</b>			
420	Printing, Binding, &c. . . . .	450	0 0	
187	Postage, Packing, and Delivery . . . . .	184	9 1	
165	Editing, Literary Contributions, &c. . . . .	145	5 0	
30	Illustrations . . . . .	90	0 0	
				869 14 1
802				
126				
676	Less Sales (Vol. 67 and earlier) . . . . .	£ s. d.		
236	Advertisements (Vol. 68) . . . . .	213 10 7	302 14 2	566 19 11
440				
	<b>ELEMENTS OF AGRICULTURE:—</b>			
26	Binding Text Book . . . . .			31 10 0
	<b>PAMPHLETS:—</b>			
33	Report on Trials of Suction Gas Plants, Writing Report, &c. . . . .	45	0 0	
	Printing further copies . . . . .	12	13 3	
	Printing Diagrams . . . . .	9	1 6	
				66 14 9
	<b>LABORATORY:—</b>			
615	Salaries, Wages, &c. . . . .			612 16 3
	<b>OTHER SCIENTIFIC DEPARTMENTS:—</b>			
251	Consulting Botanist's Salary and Expenses . . . . .	250	0 0	
200	Zoologist's Salary . . . . .	200	0 0	
200	Grant to Royal Veterinary College . . . . .	200	0 0	
2	Medals for Proficiency in Cattle Pathology . . . . .	2	8 6	
653				652 8 6
	<b>EXAMINATION FOR NATIONAL DIPLOMA IN AGRICULTURE:—</b>			
170	Honoraria and Expenses of Examiners . . . . .	161	10 1	
18	Travelling Expenses of Officials . . . . .	18	13 11	
27	Hotel Expenses of Examiners and Officials . . . . .	27	12 1	
25	Printing, Stationery, and Advertising, &c. . . . .	20	19 6	
21	Writing Diplomas . . . . .	11	1 0	
50	Salary for Assistance . . . . .	68	10 0	
				308 6 7
311	Less Entry Fees received and Sales of Examination Papers . . . . .	89	5 8	
87				219 0 11
224	Less Amount received from Highland and Agricultural Society . . . . .	95	13 11	123 7 0
102				
122				
	<b>EXAMINATION FOR NATIONAL DIPLOMA IN DAIRYING:—</b>			
20	Milk, Cream, and Appliances for Examination . . . . .	14	2 0	
46	Fees to Examiners . . . . .	40	6 11	
11	Maintenance and Travelling Expenses . . . . .	20	17 9	
9	Printing and Postage . . . . .	1	19 9	
				77 6 5
86	Less Entry Fees and Sales of Examination Papers, &c. . . . .	29	17 2	
13				47 9 3
73	Contribution to Show Fund . . . . .			2,000 0 0
2,000	Credit Balance carried to Balance-sheet . . . . .			431 3 9
—				
£8,799				£8,298 13 11

Examined, audited, and found correct, this 10th day of February, 1908.

JONAS M. WEBB,  
HUBERT J. GREENWOOD, } Auditors on behalf of the Society.  
NEWELL P. SQUAREY,

# Royal Agricultural Society of England.

STATEMENT OF FUNDS HELD BY THE SOCIETY IN TRUST OR WHICH ARE NOT  
CONSIDERED AVAILABLE FOR GENERAL PURPOSES, DECEMBER 31, 1907.

	£	s.	d.		£	s.	d.
To Hills' Bequest for Pot-culture Experiments . . . . .	9,000	0	0	By 8,126 <i>l.</i> 8 <i>s.</i> 2 <i>d.</i> Consols. at cost . . . . .	9,000	0	0
To Fund provided by Sir Walter Gilbey for Endowment of Lectureship at Cambridge until July 31, 1917, when any balance on this account will become the property of the Society . . . . .				By 1,140 <i>l.</i> Metropolitan Water Board Stock A at cost . . . . .	998	1	0
				By amount included in the Society's Sundry Creditors' Account : £ s. d.			
				Fund uninvested . . . . .	1	19	0
				Less Income overspent . . . . .	1	6	6
					0	12	6
					£9,998	13	6

xxii

Examined, audited, and found correct, this 10th day of February, 1908.

THOMAS MCBROW, *Secretary.*  
WELTON, JONES & CO., *Accountants.*

JONAS M WEBB,  
HUBERT J. GREENWOOD, } *Auditors on*  
NEWBY & COMPANY, } *behalf of*



## LINCOLN SHOW, 1907.

Statement showing the distribution of the Prizes awarded in the several sections of the Lincoln Show, with comparative figures of the Derby Show.

Corresponding figures for 1906.	STATEMENT OF PRIZES AWARDED		
	£	<i>(Exclusive of Cups and Medals).</i>	
		£	s. d.
1,830	Horses . . . . .	2,570	0 0
2,093	Cattle . . . . .	2,483	5 0
1,357	Sheep . . . . .	1,782	0 0
441	Pigs . . . . .	557	5 0
182	Poultry . . . . .	159	5 0
90	Cheese and Butter . . . . .	73	0 0
40	Cider and Perry . . . . .	40	0 0
51	Wool . . . . .	63	0 0
16	Horse-Shoeing . . . . .	27	0 0
168	Implements . . . . .	50	0 0
40	Contribution to Bee Department . . . . .	40	0 0
<hr/> 6,308 <hr/>		<hr/> £7,844 <hr/>	<hr/> 15 0 <hr/>

## STATEMENT OF RECEIPTS AND EXPEN-

JUNE 25 TO

Corresponding figures for 1908.		Receipts.		£ s. d.	£ s. d.
2,000	Subscription from Lincoln Local Committee . . . . .				2,000 0 0
	Prizes given by various Breed Societies. . . . .	2,988	16	0	
2,539	Do. do. Lincoln Local Committee . . . . .	1,000	0	0	3,988 16 0
	<b>FEES FOR ENTRY OF IMPLEMENTS:—</b>				
	Implement Exhibitors' Payments for Shedding . . . . .	5,639	18	3	
	Non-Members' Fees for Entry of Implements . . . . .	182	0	0	
5,965	Fees for Entry of "New Implements" . . . . .	51	0	0	5,872 18 3
	<b>FEES FOR ENTRY OF LIVE STOCK:—</b>				
	By Members:—1,918 Entries @ 1 <i>l.</i> . . . . .	1,918	0	0	
	297 Entries @ 3 <i>0s.</i> . . . . .	445	10	0	
	167 Entries @ 2 <i>l.</i> . . . . .	334	0	0	
	39 Post Entries @ 2 <i>l.</i> . . . . .	78	0	0	
	3 Post Entries @ 5 <i>0s.</i> . . . . .	7	10	0	
2,186 } 877 }	By Non-Members:—133 Entries @ 2 <i>l.</i> . . . . .	266	0	0	2,783 0 0
	63 Entries @ 3 <i>l.</i> . . . . .	189	0	0	
	11 Entries @ 4 <i>l.</i> . . . . .	44	0	0	
	5 Post Entries @ 4 <i>l.</i> . . . . .	20	0	0	
	1 Post Entry @ 5 <i>l.</i> . . . . .	5	0	0	
521	223 Entries @ 5 <i>s.</i> . . . . .				524 0 0
40					55 15 0
	<b>FEES FOR ENTRY OF POULTRY:—</b>				
	By Members:—185 Entries @ 2 <i>s. 6d.</i> . . . . .	23	2	6	
180	By Non-Members:—640 Entries @ 3 <i>s. 6d.</i> . . . . .	112	0	0	135 2 6
	<b>OTHER ENTRY FEES:—</b>				
65	Fees for Entry of Produce . . . . .				45 5 6
21	Fees for Entry in Horse-shoeing Competition . . . . .				32 5 0
36	Fees for Entry in Horse-Jumping Competition, &c. . . . .				102. 0 0
	<b>CATALOGUE:—</b>				
15	Extra Lines for Particulars of Implement . . . . .	17	10	0	
6	Exhibits . . . . .	4	2	6	
183	Woodcuts of "New Implements" . . . . .	235	10	0	
22	Advertising in Catalogue . . . . .	19	3	9	
642	Sales of Implement Section of Catalogue (including bound copies) . . . . .	653	7	6	
1	Sales of Combined Catalogue . . . . .	21	9	10	
809	Sales of Programmes . . . . .				951 3 7
26	Less Commission on Sales . . . . .				84 14 0
843					916 9 7
	<b>MISCELLANEOUS RECEIPTS:—</b>				
65	Amount received from Refreshment Contractors . . . . .	465	0	0	
3	Rent of Railway Offices . . . . .	95	10	0	
35	Premium for Cloak Room . . . . .	60	0	0	
30	Rent for Board of Agriculture Pavilion . . . . .	30	0	0	
15	Contribution to Show Fund . . . . .	30	0	0	
5	Miscellaneous . . . . .	4	5	6	
676					684 15 6
5,949	Carried forward . . . . .				417,080 7 4



# DITURE OF THE SHOW AT LINCOLN, 29, 1907.

xxv

Corresponding figures for 1906.

	<b>Expenditure.</b>	£ s. d.	£ s. d.	£ s. d.
5	<b>COST OF ERECTION OF SHOWYARD:—</b>			
	Transferring Society's Plant from Derby to Lincoln (including re-erection) . . . . .		1,400 0 0	
1,234	Fencing round Showyard . . . . .		668 12 7	
765	Erection of Implement Shedding . . . . .		1,427 18 0	
1,415	Erection of Stock Shedding . . . . .		2,909 0 11	
2,919	Erection of Poultry and Produce Sheds . . . . .		223 8 0	
223	Erection of Dairy . . . . .		215 0 0	
85	Erection of Fodder Shed, Office, &c. . . . .		60 0 0	
542	Erection of Grand Stand, &c. . . . .		401 15 3	
92	Erection of Horse-Shoeing Shed . . . . .		104 0 0	
1,213	Various Offices and Stands: Bee Shed, Lavatories, Stables, Lunging Rings, &c. . . . .		1,224 7 3	
165	Printing Signs and fixing do., providing and fixing Judging Hurdles, erecting Temporary Exit Sheds, and constructing Platform in front of Entrances . . . . .		172 0 0	
7	Insurance . . . . .		5 16 6	
12	Ironmongery . . . . .		17 19 0	
110	Forestry Exhibition . . . . .		135 5 10	
101	Board of Agriculture Pavilion . . . . .		23 12 6	
90	Hire of Canvas, Felt, &c. . . . .		1,080 13 3	
38	General Labour and Horse Hire (including Society's Clerk of Works) . . . . .		535 12 2	
26			10,006 1 3	
1,290				
415				
10,742				
502	Less 17½ per cent. on 8,174l. 13s. 1d. (as per contract) . . . . .	1,430 11 4		
	67 Flag Poles at 10s. . . . .	33 10 0		
			1,464 1 4	
10,240				9,140 19 11
500	<b>SURVEYOR:—</b> Salary, 300l.; Travelling Expenses, 43l. 1s. . . . .			343 1 0
528	<b>PRINTING:—</b> Printing of Prize Sheets, Entry Forms, Admission Orders, Circulars to Exhibitors, Prize Cards, &c., Tickets, and Miscellaneous . . . . .		568 15 9	
69	Programmes for Members . . . . .		102 3 6	
25	Plans of Showyard . . . . .		33 3 4	
618	Printing of Catalogues . . . . .		642 1 11	
99	Binding of Catalogues . . . . .		103 2 6	
30	Carriage of Catalogues to Showyard . . . . .		14 12 5	
74	Printing Awards . . . . .		58 8 4	
18	Programmes of Jumping Competitions . . . . .		7 17 6	
1,461				1,530 5 3
961	<b>ADVERTISING:—</b> Advertising Closing of Entries in Newspapers . . . . .		136 6 3	
	Advertising Show in Newspapers . . . . .		178 0 1	
	Bill Posting . . . . .		405 13 6	
	Printing of Posters and Placards . . . . .		228 9 6	
	Press Visit, &c., before Show . . . . .		62 9 0	
				1,010 18 4
71	<b>POSTAGE, CARRIAGE, &amp;C.:—</b> General Postage . . . . .		82 13 10	
34	Postage of Tickets to Members . . . . .		33 12 1	
11	Carriage of Luggage . . . . .		12 2 1	
116				128 8 0
6,308	<b>AMOUNT OF MONEY PRIZES AWARDED, including 3,898l. 16s. given by various Societies and Lincoln Local Committee (see receipt per contra)</b> [See page xxiii for Statement of Distribution of Prizes.]			7,844 15 0
647	<b>COST OF FORAGE FOR LIVE STOCK:—</b> Hay, 262l. 4s. 8d.; Straw, 315l. 15s. 9d.; Green Food, 182l. 14s. 7d.; Insurance, 1l. 17s. 6d.; Wages, &c., 10l. 13s. 7d.)			773 6 1
456	<b>JUDGES' FEES AND EXPENSES:—</b> Judges of Implement Trials, 19l. 2s.; Miscellaneous Implements, 20l. 16s. 6d.; Judges of Horses, 66l. 16s. 1d.; Cattle, 138l. 11s. 1d.; Sheep, 81l. 6s. 8d.; Pigs, 29l. 17s.; Poultry, 13l. 13s. 7d.; Butter, 6l. 9s. 4d.; Cheese, 3l. 15s. 2d.; Cider and Perry, 9l. 4s.; Wool, 7l. 15s. 10d.; Horse-Shoeing, 33l. 2s. 4d.; Luncheons, 26l. 15s. 4d.			467 4 11
£20,689	Carried forward . . . . .			£21,238 18 6

Corresponding figures for 1906.

£  
15,949

## Receipts (contd.).

£ s. d. £ s.  
17,050

Brought forward . . . . .

## ADMISSIONS TO SHOWYARD:—

685	Tuesday, June 25, @ 5s.	389	10	0
2,991	Wednesday, June 26, @ 2s. 6d.	2,705	0	6
—	Thursday, June 27, @ 2s. 6d.	2,749	8	6
2,019	Friday, June 28, @ 1s.	2,475	11	6
1,993	Saturday, June 29, @ 1s.	1,442	9	0
502	Day Tickets	360	11	6
96	Season Tickets	135	1	0
8,286				10,257 1

## ENTRANCES TO HORSE RING:—

—	Wednesday, June 26	142	16	0
265	Thursday, June 27	186	19	0
162	Friday, June 28	148	0	0
138	Saturday, June 29	86	11	0
239	Tickets sold for Reserved Enclosure	551	7	0
805				1,129

## DAIRY:—

52	Sales of Produce at Dairy	98
325	Auction Sales in Showyard and Share of Commission	343

25,417£28,878

Examined, audited, and found correct, this 20th day of November, 1907.

JAMES MCKEOW, Secretary.  
WILLIAM JONES & CO., Accountants.JONAS M. WEBB,  
HUBERT J. GREENWOOD, } Auditors  
behalf of  
the Society

OF THE SHOW AT LINCOLN (continued).

X.

Corresponding figures for 1926.		£	s.	d.	£
20,689	Brought forward . . . . .				21,238
49	Badges for Judges and other Officials . . . . .				23
42	Rosettes . . . . .				46
<b>GENERAL ADMINISTRATION:—</b>					
70	<i>Stewards</i> :—Personal and Railway Expenses . . . . .	85	8	6	
49	<i>Assistant Stewards</i> :—Personal and Railway Expenses . . . . .	58	19	3	
193	<i>Official Staff</i> :—Extra Clerks, 106 <i>l.</i> 1 <i>s.</i> 10 <i>d.</i> ; Lodgings, 29 <i>l.</i> 15 <i>s.</i> ;	209	14	3	
	Maintenance of Clerks, 33 <i>l.</i> ; Travelling Expenses, 5 <i>l.</i> 18 <i>s.</i> 8 <i>d.</i> ; Secretary's Hotel and Travelling Expenses, 34 <i>l.</i> 18 <i>s.</i> 9 <i>d.</i> .				
	<i>Finance Office</i> :—Superintendent of Turnstiles, 10 <i>l.</i> 10 <i>s.</i> ;				
79	Grand Stand Men, 18 <i>l.</i> 9 <i>s.</i> 9 <i>d.</i> ; Turnstile Men, 30 <i>l.</i> ;	78	19	9	
	Bank Clerks, 20 <i>l.</i> . . . . .				
34	<i>Awards Office</i> :—Clerks, 30 <i>l.</i> 3 <i>s.</i> 3 <i>d.</i> ; Awards Boys, 10 <i>l.</i> 11 <i>s.</i> . . . . .	40	14	3	
425					471
<i>General Management</i> :—					
47	Foreman and Assistant Foremen . . . . .	39	7	5	
78	Yardmen and Foddermen . . . . .	88	18	9	
51	Door and Gate Keepers . . . . .	39	3	3	
13	Carriage and Horse Hire . . . . .	10	13	0	
108	<i>Veterinary Department</i> :—Veterinary Inspectors . . . . .	89	19	8	
97	<i>Engineering Department</i> :—Consulting Engineer and Assistants 84 <i>l.</i> ; Wages to Workmen, 13 <i>l.</i> 15 <i>s.</i> 9 <i>d.</i> ; House and Maintenance, 18 <i>l.</i> ; Repairs, 30 <i>l.</i> 18 <i>s.</i> 6 <i>d.</i> .	146	14	3	
	<i>Police, &amp;c.</i> :—Metropolitan Police, 527 <i>l.</i> 6 <i>s.</i> 11 <i>d.</i> ; Commissioners, 23 <i>l.</i> 4 <i>s.</i> 6 <i>d.</i> .				
491		550	11	5	
885					965
236	<i>Dairy</i> :—Staff, 104 <i>l.</i> 8 <i>s.</i> ; Milk, 64 <i>l.</i> 14 <i>s.</i> 1 <i>d.</i> ; Ice, 13 <i>l.</i> 7 <i>s.</i> 6 <i>d.</i> ;				
	Utensils, 51 <i>l.</i> 8 <i>s.</i> 7 <i>d.</i> ; Salt, 1 <i>l.</i> 18 <i>s.</i> ; Butter Tests, 16 <i>l.</i> 5 <i>s.</i> 9 <i>d.</i> ;				
	Milk Analyses, 16 <i>l.</i> 8 <i>s.</i> 10 <i>d.</i> ; Carriage, 3 <i>l.</i> 12 <i>s.</i> 6 <i>d.</i> ; Fuel, 2 <i>l.</i> 5 <i>s.</i> 10 <i>d.</i> ; Engine, 4 <i>l.</i> 6 <i>s.</i> ; Cheese and Butter Boxes, 3 <i>l.</i> 10 <i>s.</i> 9 <i>d.</i> ; Lodgings, 1 <i>l.</i> 18 <i>s.</i> 6 <i>d.</i> ; Refreshments, 6 <i>l.</i> 18 <i>s.</i> 6 <i>d.</i> ; Miscellaneous Payments, 2 <i>l.</i> 18 <i>s.</i> .				
42	<i>Poultry</i> :—Superintendent, 10 <i>l.</i> 0 <i>s.</i> 9 <i>d.</i> ; Penning, Attendants, and Food, 17 <i>l.</i> 3 <i>s.</i> 8 <i>d.</i> ; Carriage, 10 <i>l.</i> 10 <i>s.</i> 1 <i>d.</i> .				37
26	<i>Horse-shoeing</i> :—Hire of Forges, 19 <i>l.</i> 6 <i>s.</i> 0 <i>d.</i> ; Fuel, 2 <i>l.</i> 14 <i>s.</i> 6 <i>d.</i> ;				42
19	Gratuities, 8 <i>l.</i> 19 <i>s.</i> 7 <i>d.</i> ; Wages, 2 <i>l.</i> 18 <i>s.</i> 4 <i>d.</i> ; Carriage, 5 <i>l.</i> 15 <i>s.</i> ; Refreshments, 2 <i>l.</i> 14 <i>s.</i> . . . . .				
	<i>Produce</i> :—Analyses of Cider and Water . . . . .				19
<b>GENERAL SHOWYARD EXPENSES:—</b>					
141	Military Band . . . . .	103	7	6	
50	St. John Ambulance . . . . .	45	9	5	
53	Official Luncheons . . . . .	55	1	10	
82	Hire of Furniture . . . . .	60	6	0	
—	Horse Ring (levelling and draining) . . . . .	51	2	2	
—	Horse Hire . . . . .	21	5	10	
10	Floral Decorations, &c. . . . .	2	3	6	
23	Education and Forestry Exhibition . . . . .	45	3	6	
3	Bath Chairs . . . . .	10	1	0	
21	Telephone Extension . . . . .	53	17	10	
15	Tan, &c. . . . .	24	10	10	
—	Billposting in Showyard . . . . .	16	19	5	
111	Telegraph Extension . . . . .	6	10	0	
19	Hire of Weighbridge . . . . .	10	12	6	
—	Hire of Chairs . . . . .	63	17	4	
38	Medals . . . . .	10	18	0	
15	Hire of Turnstiles . . . . .	9	9	6	
74	Fuel . . . . .	3	3	4	
26	Hire of Royal Arms, 2 <i>l.</i> 10 <i>s.</i> ; Stoves, 1 <i>l.</i> 10 <i>s.</i> ; Sheep Trays, } 14 <i>s.</i> ; Washing Towels, 1 <i>l.</i> 6 <i>s.</i> 6 <i>d.</i> . . . . .	6	0	6	
22	Miscellaneous . . . . .	19	13	6	
729	Trials of Swath Turners and Side Delivery Rakes . . . . .				619
247	Credit Balance . . . . .				63
2,028					5,056
<b>£25,417</b>					<b>£28,878</b>

Actual profit to the Society on the Lincoln Show . . . . .	£5,056	0	10
Contribution from Ordinary Funds of the Society to the Show Fund . . . . .	2,000	0	0
<b>Balance carried to Reserve Fund . . . . .</b>	<b>£7,056</b>	<b>0</b>	<b>10</b>

Y 2

## MEMORANDA.

**ADDRESS OF LETTERS.**—All letters on the general business of the Society should be addressed to "The Secretary, Royal Agricultural Society of England, 16 Bedford Square, London, W.C."

**TELEGRAMS.**—Registered address for telegrams: "Practice London."

**TELEPHONE NUMBER.**—3675, "Gerrard."

**OFFICE HOURS.**—10 to 4. On Saturdays, 10 to 2.

**ANNUAL GENERAL MEETING,** Wednesday, December 9, 1908.

**MONTHLY COUNCIL** (for transaction of business), at noon: usually on the first Wednesday in every month, excepting January, September, and October: open only to Members of Council and Governors of the Society.

**SUBSCRIPTIONS.**—1. *Annual.*—The minimum subscription of a Governor is 5*l.*, and that of a Member 1*l.*, due in advance on the 1st of January of each year, and becoming in arrear if unpaid by the 1st of June.

2. *For Life.*—Governors may compound for their subscriptions for future years by paying at once the sum of 50*l.*, and Members by paying 15*l.* After payment of ten or more annual subscriptions, a Member may compound for future subscriptions, including that of the current year, by a single payment of 10*l.*; and after payment of twenty or more annual subscriptions, by a single payment of 5*l.*—or 25*l.* in the case of Governors.

No Governor or Member can be allowed to enter into a composition for life until all subscriptions due by him at the time shall have been paid.

No Governor or Member whose subscription is in arrear is entitled to any of the privileges of the Society.

All Members of the Society are, under the By-laws, bound to pay their annual subscriptions until they shall withdraw from it by notice in writing to the Secretary.

**PAYMENTS.**—Subscriptions may be paid to the Secretary, either at the office of the Society, 16 Bedford Square, London, W.C.; or by means of crossed cheques in favour of the Secretary, or by crossed postal orders. When making remittances it should be stated by whom, and on whose account, they are sent. All Cheques and Postal Orders should be crossed "London and Westminster Bank."

On application to the Secretary, forms may be obtained for authorising the regular payment, by the Bankers of individual Members, of each annual subscription as it falls due. Members are particularly invited to avail themselves of these Bankers' orders, in order to save trouble both to themselves and to the Society. When payment is made to the London and Westminster Bank, as the Bankers of the Society, it will be desirable that the Secretary should be advised by letter of such payment, in order that the entry in the Bankers' book may be at once identified, and the amount posted to the credit of the proper person. No coin can be remitted by post, unless the letter be registered.

**JOURNAL.**—The Volumes of the Society's Journal are (when the subscription is not in arrear) forwarded by post to Members, or delivered from the Society's Office to Members, or to the bearer of their written order.

The back numbers of the Journal are kept constantly on sale by the publisher, Mr. JOHN MURRAY, 50A Albemarle Street, W.

**NEWCASTLE MEETING, JUNE 30 TO JULY 4, 1908.** Entries close: Implements, March 16; post entries, April 1. Live Stock, May 14; post entries, May 28. Riding and Driving Classes, May 28. Poultry, May 28. Produce, May 14; post entries (except cider and perry), May 28.

**NEW MEMBERS.**—Every candidate for admission into the Society must be nominated by a Governor or Member, and must duly fill up and sign an application for Membership on the appointed form. Forms of proposal may be obtained on application to the Secretary, who will inform new Members of their election by letter.

[Copies of the full Report of any of the Council Meetings held during the year 1907 may be obtained on application to the Secretary, at 16 Bedford Square, London, W.C.]

## ROYAL AGRICULTURAL SOCIETY OF ENGLAND.

### Minutes of the Council.

WEDNESDAY, JANUARY 30, 1907.

At a Monthly Council, held at the Hotel Russell, the Earl of YARBOROUGH (President) in the Chair :—

**Present:—Trustees.**—Mr. F. S. W. Cornwallis, the Earl of Coventry, Lord Middleton, Lord Moreton, Sir J. H. Thorold, Bart.

**Vice-Presidents.**—Mr. J. Bowen-Jones, Mr. Percy Crutchley, the Earl of Northbrook.

**Other Members of the Council.**—Mr. George Adams, Mr. Charles R. W. Adeane, Mr. T. L. Aveling, Mr. S. N. Bankart, Mr. H. D. Brocklehurst, Sir Richard P. Cooper, Bart., Sir H. F. de Trafford, Bart., Mr. H. Dudding, Mr. J. T. C. Eadie, Mr. James Falconer, Mr. J. W. Glover, Mr. R. M. Greaves, Sir Gilbert Greenall, Bart., Mr. J. Harris, Mr. W. Harrison, Mr. A. Hiscock, Mr. R. W. Hobbs, Mr. J. Howard Howard, Mr. W. F. Ingram, Mr. Ernest Mathews, Mr. W. A. May, Mr. C. Middleton, Mr. T. S. Minton, Mr. Ralph Palmer, Mr. C. M. S. Pilkington, Mr. G. G. Rea, Mr. F. Reynard, Mr. C. C. Rogers, Mr. E. W. Shackle, Mr. E. W. Stanyforth, Mr. H. Tallent, Mr. George Taylor, Mr. John Thornton, Mr. A. P. Turner, and Mr. E. V. V. Wheeler.

The following Members of the Lincoln Local Committee were also present :—Mr. W. Frankish, Mr. C. W. Tindall, and Mr. E. E. Tweed (Local Secretary).

The minutes of the last meeting of the Council held on Wednesday, December 12, 1906, were taken as read and approved.

Mr. Waldorf Astor, jun., and Mr. A. Cecil Beck, M.P., were elected Governors of the Society under By-law 2, and the names of Sir Richard P. Cooper, Bart., and Lord Savile, K.C.V.O., were transferred from the List of Members to the List of Governors in accordance with the provisions of By-law 9.

Fifty-one duly nominated candidates were admitted into the Society as Members under By-law 2.

The Report of the Sites Committee having been received and adopted, a Deputation was introduced from the authorities of Newcastle-upon-Tyne in support of an invitation to the Society to hold its Show of 1908 in that City. After speeches by the LORD MAYOR OF NEWCASTLE and others, a Memorial was read by the ACTING TOWN CLERK, and the Deputation retired. On the motion of Sir GILBERT GREENALL, seconded by Mr. HARRISON, it was unanimously decided that, subject to the usual formalities being completed, the invitation tendered by the Lord Mayor, on behalf of the City Council and Citizens of Newcastle-upon-Tyne, to hold the Show in that City in 1908, be accepted by the Council.

The Report of the Finance Committee was received and adopted, and on the motion of Mr. ADEANE, seconded by Mr. CORNWALLIS, the following resolution was unanimously adopted by the Council :—

"That the Conditional Contract, dated January 29, 1907, entered into by the Chairman of the Finance Committee (as agent for the Society, acting on the authority of the Finance and House Joint Committee) for the sale to the Central London Property Syndicate, Ltd., of No. 13 Hanover Square, for £5,000, be and the same is hereby ratified."

In accordance with the recommendation of the Committee of Selection, the following gentlemen were appointed as Stewards for the Lincoln Show :— *Horses*, Mr. Reynard and Mr. Kowell ; *Cattle*, Mr. Ingram ; *Sheep*, Mr. Wheeler ; *Pigs*, Mr. Dugdale ; *Dairying and Poultry*, Mr. Mathews ; *Veterinary Examination*, Mr. Cyril Greenall ; *Implements*, Mr. Greaves and Mr. Pilkington ; *Refreshments*, Mr. Harrison.

Mr. PILKINGTON reported the recommendation of the Committee appointed on August 1 last, that the Conference with representatives of Agricultural and Breed Societies should take place at 3 p.m. on Wednesday, February 27, at the Hotel Russell.

The various suggestions made by Members at the Annual General Meeting held on Wednesday, December 12, 1906, were considered and replies thereto settled in accordance with the recommendations made by the Botanical, Show-yard Works, Dairy and General Lincoln Committees.

Other business having been transacted, the Council adjourned until Wednesday, February 27, 1907, at 11 a.m.

### WEDNESDAY, FEBRUARY 27, 1907.

At a Monthly Council, held at the Hotel Russell, the Earl of YARBOROUGH (President) in the Chair :—

**Present** :—*Trustees*.—Mr. F. S. W. Cornwallis, the Earl of Derby, K.G., Lord Middleton, Lord Moreton, Sir J. H. Thorold, Bart.

*Vice-Presidents*.—Mr. J. Bowen-Jones, the Rt. Hon. Victor C. W. Cavendish, M.P., Mr. Percy Crutchley, Mr. J. Marshall Dugdale, the Rt. Hon. A. E. Fellowes, the Earl of Northbrook, the Hon. C. T. Parker.

*Other Members of the Council*.—Mr. George Adams, Mr. Charles R. W. Adeane, Mr. T. L. Aveling, Mr. S. N. Bankart, Mr. John Barker, M.P., Mr. H. D. Brocklehurst, Mr. R. G. Carden, Sir Richard P. Cooper, Bart., Sir H. F. de Trafford, Bart., Mr. H. Dudding, Mr. R. Forrest, Mr. J. W. Glover, Mr. R. M. Greaves, Sir Gilbert Greenall, Bart., Mr. W. Harrison, Mr. J. H. Hine, Mr. R. W. Hobbs, Mr. J. Howard Howard, Mr. W. F. Ingram, Sir Charles V. Knightley, Bart., Mr. Ernest Mathews, Mr. W. A. May, Mr. C. Middleton, Mr. T. H. Miller, Mr. T. S. Minton, Mr. C. M. S. Pilkington, Mr. F. Reynard, the Duke of Richmond and Gordon, K.G., Mr. E. W. Shackle, Mr. H. H. Smith, Mr. R. Stratton, Mr. George Taylor, Mr. John Thornton, Mr. A. P. Turner, and Mr. C. W. Wilson.

The following Members of the Lincoln Local Committee were also present :—Mr. A. H. Clark, Mr. W. Frankish, Mr. C. W. Tindall, and Mr. E. E. Tweed (Local Secretary).

The minutes of the last meeting of the Council, held on Wednesday, January 30, 1907, were taken as read and approved.

The name of the Duke of Northumberland, K.G., was transferred from the List of Members to the List of Governors under By-law 9.

Eighty-five duly nominated candidates were admitted into the Society as Members, and the name of one Member (Sir Charles Morrison-Bell, Bart.) was restored to the Registers under By-law 14.

The Report of the Finance Committee having been received and adopted, Mr. ADEANE (Chairman) explained the various items of the Balance-sheet for the year 1906, and presented the Committee's Estimates of Receipts and Expenditure for the ensuing year, 1907.

Lord MORETON, in presenting the Report of the Education Committee, explained that he had been requested by the Board of Agriculture to represent the Society on a Departmental Committee which had been appointed to go into the question of Agricultural Education ; and he hoped that the Council would approve of his action in consenting to act as the Society's representative.

Sir GILBERT GREENALL reported that the following Judges had been invited for the Farm Prize Competition :—CLASSES I. and III. (*Large Farms*)

—Mr. T. H. Hutchinson, of Manor House, Catterick, and Mr. Arthur Stretton, of Manor House, Sibthorpe, Newark. CLASSES II. and IV. (*Small Farms*)—Mr. R. B. Burrows, of Leadenham, Lincoln, and Mr. Robert Fisher, of Leconfield, Beverley. The Judges would commence their duties on Monday, March 4.

Mr. PILKINGTON reported that an agenda had been prepared for the Conference of Agricultural and Breed Societies to take place that afternoon, and that copies had been sent to the delegates appointed by the several Societies.

Other business having been transacted, the Council adjourned until Wednesday, March 27, 1907.

## Conference of Representatives of Agricultural and Breed Societies,

HELD AT THE HOTEL RUSSELL,

WEDNESDAY, FEBRUARY 27, 1907.

THE EARL OF YARBOROUGH IN THE CHAIR.

In accordance with a recommendation of the Special Committee which sat in September, 1905, the Council invited representatives of all the Agricultural and Breed Societies in the country to attend a Conference, which was held at the Hotel Russell on February 27 last, and was attended by 139 delegates, representing 68 Societies.

Discussions took place with regard to the arrangements and dates for the several Shows, fraudulent practices by exhibitors, and the question of uniform colours for prize cards and rosettes.

On the motion of the late Earl WINTERTON, it was resolved to send a Deputation to the Railway Clearing House with the view of obtaining increased facilities for the Public and Officials travelling by rail to Agricultural Shows.

[The Deputation was received by the General Managers of the various Railway Companies at the Clearing House on May 7, 1907. The requests of the Conference having been submitted by the Earl of YARBOROUGH, the CHAIRMAN of the Meeting promised the careful consideration of the Companies to the requests which had been submitted to them. The reply of the Companies will be found in the letter received from the Secretary of the Railway Clearing House, page xli.]

## WEDNESDAY, MARCH 27, 1907.

At a Monthly Council, held at 16 Bedford Square, W.C., Mr. F. S. W.  
CORNWALLIS (Trustee) in the Chair:—

**Present:—Vice-Presidents.**—The Rt. Hon. Victor C. W. Cavendish, M.P., Mr. J. Marshall Dugdale, the Rt. Hon. A. E. Fellowes.

**Other Members of the Council.**—Mr. Charles R. W. Adeane Mr. T. L. Aveling, Mr. S. N. Bankart, Mr. John Barker, M.P., Mr. H. D. Brocklehurst, Sir Richard P. Cooper, Bart., Mr. J. Falconer, Mr. R. Forrest, Mr. J. W. Glover, Mr. R. M. Greaves, Sir Gilbert Greenall, Bart., Mr. W. Harrison, Mr. R. J. Bayntun Hippisley, Mr. R. W. Hobbs, Mr. W. F. Ingram, Mr. Ernest Mathews, Mr. W. A. May, Mr. C. Middleton, Mr. Ralph Palmer, Mr. H. F. Plumpton, Mr. G. G. Rea, Mr. F. Reynard, the Duke of Richmond and Gordon, K.G., Mr. John Rowell, Mr. H. Tallent, Mr. G. Taylor, and Mr. John Thornton.

The following Members of the Lincoln Local Committee were also present:—Mr. W. Frankish, Mr. C. W. Tindall, and Mr. E. E. Tweed (Local Secretary).

In the absence, through ill-health, of the President (the Earl of Yarborough), Mr. Cornwallis was called to the Chair, on the motion of Mr. ADEANE, seconded by Mr. REYNARD.

The CHAIRMAN, in opening the proceedings, asked the Members of the Council to make it known outside how much they would welcome Members of the Society in that building, which, if more restricted, contained the same facilities as in their old house—namely, a reading room, and a library into which the books would be put towards the end of the summer, when the room was perfectly dry.

The minutes of the last meeting of the Council, held at the Hotel Russell on Wednesday, February 27, 1907, were taken as read and approved.

Seventy-two duly nominated candidates were admitted into the Society as Members, under By-law 2.

In moving the adoption of the report of the Showyard Works Committee, Sir GILBERT GREENALL mentioned that the levelling of the Showyard was well in hand, and that most of it would be completed within a week. The whole of the implement shedding and 5,000 feet of cattle shedding was being erected. The erection of fencing round the Showyard was all completed.

The Report of the Committee of Selection was, after a short discussion, received and adopted, including a recommendation for the appointment of a Sub-Committee, consisting of Sir John Thorold (Chairman), Mr. Adeane and Mr. Cornwallis, to go into the question of the revision of the Society's By-laws, and to bring up recommendations for submission to the Committee at a future Meeting.

The SECRETARY reported that he had been in communication with the Secretary of the Railway Clearing House with regard to the Resolution passed by the Conference of representatives of Agricultural and Breed Societies held on February 27, and that the General Managers of the various Railway Companies would receive the Deputation from the Conference at 11 a.m. on Tuesday, May 7.

Sir GILBERT GREENALL reported that the Judges of the Farm Prize Competition had completed their preliminary tour of inspection, and had selected certain of the Farms, which they proposed to re-visit during the month of June, at a time as near as practicable to the date of the Lincoln Show.

On the motion of the CHAIRMAN, seconded by Mr. J. W. GLOVER, it was unanimously resolved:—"That the Seal of the Society be affixed to the Conveyance of Harewood House, 13 Hanover Square, to the Central London Property Syndicate, Limited."

Other business having been transacted, the Council adjourned until Wednesday, May 1, 1907, at 11 a.m.

---

### WEDNESDAY, MAY 1, 1907.

At a Monthly Council, held at 16 Bedford Square, W.C., the Earl of YARBOROUGH (President) in the Chair:—

**Present:—Trustees.**—Mr. F. S. W. Cornwallis, the Earl of Derby, K.G., Earl Egerton of Tatton, Sir J. H. Thorold, Bart.

**Vice-Presidents.**—Mr. J. Bowen-Jones, Mr. Percy Crutchley, Mr. J. Marshall Dugdale, the Rt. Hon. A. E. Fellowes, the Earl of Feversham, the Earl of Jersey, G.C.B., the Hon. C. T. Parker.

**Other Members of the Council.**—Mr. George Adams, Mr. Charles R. W. Adeane, Mr. T. L. Aveling, Mr. S. N. Bankart, Mr. H. D. Brocklehurst, Mr. Richardson Carr, Sir Richard P. Cooper, Bart., Mr. R. Forrest, Mr. J. W. Glover, Mr. R. M. Greaves, Sir Gilbert Greenall, Bart., Mr. Joseph Harris, Mr. W. Harrison, Mr. Arthur Hiscock, Mr. R. W. Hobbs, Mr. Ernest Mathews, Mr.



C. Middleton, Mr. C. M. S. Pilkington, Mr. H. F. Plumtre, Mr. F. Reynard, Mr. W. Scoby, Mr. E. W. Shackle, Mr. E. W. Stanyforth, Mr. R. Stratton, Mr. Herbert Tallent, Mr. John Thornton, and Mr. E. V. V. Wheeler.

The following Members of the Lincoln Local Committee were also present :—  
Mr. A. H. Clark, Mr. W. Frankish, Mr. C. W. Tindall, and Mr. E. E. Tweed (Local Secretary).

In opening the proceedings, the PRESIDENT made sympathetic reference to the death, on April 7 last, of Mr. Albert Pell, of Hazelbeach, Northampton. Mr. Pell was elected a Member of the Society in 1843, and was a Member of Council from 1886 to 1905. He rendered important services on several Committees, including the Journal, Chemical, Botanical, and Veterinary Committees, and contributed to the Society's Journal many articles of interest and value to agriculturists.

The minutes of the last meeting of the Council, held on March 27, 1907, were taken as read and approved.

Mr. John Cator, of Woodbastwick Hall, Norwich, was elected a Governor of the Society; and the names of the following four Members were transferred to the list of Governors under By-law 9: The Earl of Shaftesbury, K.C.V.O., Sir George A. Cooper, Bart., Mr. C. Lee Evans, and Mr. H. H. Vivian.

The Report of the Finance Committee having been received and adopted, it was explained that in view of the fact that the Conveyance of Harewood House would be made to Sir Edward Tennant (the Chairman of the Central London Property Syndicate) instead of to the Syndicate, it would be necessary for the Council to pass a new resolution. The following resolution was thereupon moved from the Chair and carried unanimously :—"That the Seal of the Society be affixed to the Conveyance of Harewood House, 13 Hanover Square, to Sir Edward Tennant, Bart."

Sir JOHN THOROLD, having moved that the Report of the Journal Committee be received and adopted, submitted the following resolution, which was seconded by the Earl of JERSEY, and carried unanimously :—"That Major P. G. Craigie, C.B., be appointed Editor of the Society's Journal for the ensuing year."

The Report of the Chemical and Woburn Committee was received and adopted, and the Annual Visit of Inspection of the Woburn Experimental Farm by Members of the Council was fixed for Thursday, June 6 next.

On the motion of Sir JOHN THOROLD, seconded by Mr. CORNWALLIS, it was resolved unanimously that the name of the Right Hon. Victor Cavendish be suggested to the Annual General Meeting of Governors and Members in December as President of the Society for the year 1908.

In response to an invitation from the Board of Agriculture, Mr. J. Marshall Dugdale was appointed to give evidence on behalf of the Society before the Departmental Committee on Agricultural Education.

Other business having been transacted, the Council adjourned until Wednesday, June 5 (Derby Day), 1907, at 10.30 a.m.

### WEDNESDAY, JUNE 5, 1907.

At a Monthly Council, held at 16 Bedford Square, W.C., the Earl of YARBOROUGH (President) in the Chair :—

**Present :— Trustees.**—Mr. F. S. W. Cornwallis, the Earl of Coventry, Lord Middleton, Lord Moreton, Sir J. H. Thorold, Bart.

**Vice-Presidents.**—Mr. J. Bowen-Jones, Mr. Percy Crutchley, the Rt. Hon. A. E. Fellowes, the Earl of Jersey, G.C.B., the Earl of Northbrook, the Hon. C. T. Parker.

**Other Members of the Council.**—Mr. Charles B. W. Adeane, Mr. T. L. Aveling, Mr. S. N. Bankart, Mr. H. D. Brocklehurst, Sir Richard P. Cooper, Bart., Sir H. F. de Trafford, Bart., Mr. J. Falconer, Mr. R. M. Greaves,

Mr. Joseph Harris, Mr. W. Harrison, Mr. J. H. Hine, Mr. R. W. Hobbs, Mr. J. Howard Howard, Mr. George Lobb, Mr. C. Middleton, Mr. T. H. Miller, Mr. T. S. Minton, Mr. Ralph Palmer, Mr. F. Reynard, Mr. J. Rowell, Mr. E. W. Shackle, Mr. H. H. Smith, Mr. E. W. Stanyforth, Mr. H. Tallent, Mr. G. Taylor, Mr. John Thoruton, Mr. E. V. V. Wheeler, and Mr. C. W. Wilson.

The following Members of the Lincoln Local Committee were also present:—The Mayor of Lincoln (Col. J. S. Ruston), Mr. W. Frankish, Mr. C. W. Tindall, and Mr. E. E. Tweed (Local Secretary).

The minutes of the last meeting of the Council, held on May 1, 1907, were taken as read and approved.

Mr. W. W. G. Phillips was elected a Governor of the Society, and the name of Lord Brassey, G.C.B., was transferred from the List of Members to the List of Governors in accordance with By-law 9.

One hundred and fifty-eight new Members were elected under By-law 2, and the names of two Members were restored to the Registers under By-law 14.

On the motion of Mr. ADEANE, seconded by Mr. WHEELER, it was resolved: "That the Secretary be empowered to issue to any duly nominated candidate for Membership of the Society, on receipt of the annual subscription, a special ticket admitting the candidate to the same privileges as a Member during the forthcoming Show at Lincoln; the formal election of such candidate to be considered by the Council at their next Ordinary Meeting"

On the recommendation of the Committee of Selection, the Monthly Council Meeting in the Lincoln Showyard was fixed for Wednesday, June 26, 1907, at noon.

The SECRETARY announced that the Trustees of the "Queen Victoria Gifts" Fund had decided to make a grant to the Royal Agricultural Benevolent Institution of 140*l.* for the year 1907, to be distributed as fourteen grants of 10*l.* each to the five male candidates, five married couples, and four female candidates who polled the largest number of votes in their class, and who would not this year receive grants from any other fund in connection with the Royal Agricultural Benevolent Institution.

The PRESIDENT reported that the deputation from the Conference of Agricultural and Breed Societies had waited upon the general managers of the various railway companies on May 7 last, but that no reply had yet been received to the requests then put forward.

On the motion of Mr. ADEANE, seconded by Mr. CORNWALLIS, the Society's Seal was affixed to the contract which had been entered into with Messrs. John Unite, Ltd., for the supply of canvas, &c., at the Society's Shows of 1907 to 1916 inclusive.

Mr. WILSON reported that, as the Society's representative, he had on the previous day attended a meeting of the National Dustless Roads Committee of the Roads Improvement Association.

Other business having been transacted, the Council adjourned until Wednesday June 26, 1907 (in the Lincoln Showyard).

### WEDNESDAY, JUNE 26, 1907.

The Monthly Council Meeting, held in the large tent in the Lincoln Showyard, the Earl of YARBOROUGH (President) in the Chair:—

**Present:**—*Trustee*.—Mr. F. S. W. Cornwallis.

*Ex-Præsidents*.—Mr. J. Bowen-Jones, the Right Hon. Victor Cavendish, M.P., Mr. J. Marshall Dugdale, the Right Hon. A. E. Fellowes, the Earl of Northbrook.

*Other Members of the Council*.—Mr. George Adams, Mr. Charles R. Wade, Mr. T. L. Aveling, Mr. H. Dent Brocklehurst, Mr. R. G. Carden, Mr. Richardson Carr, Sir Richard P. Cooper, Bart., Mr. J. T. C. Eadie, Mr. R. M. Greening, Sir Albert Greenall, Bart., Mr. W. Harrison, Mr. A. Hiscock,

**Mr. R. W. Hobbs, Mr. W. F. Ingram, Mr. George Lobb, Mr. Ernest Mathews, Mr. W. A. May, Mr. C. Middleton, Mr. T. H. Miller, Mr. C. M. S. Pilkington, Mr. H. F. Plumpton, Mr. F. Reynard, Mr. C. C. Rogers, Mr. John Rowell, Mr. W. Scoby, Mr. R. Stratton, Mr. John Thornton, Mr. E. V. V. Wheeler, and Mr. C. W. Wilson.**

The minutes of the last meeting of the Council, held on Wednesday, June 5, were taken as read and approved.

The SECRETARY explained that as there had been no opportunity for any meetings of Committees to take place in the Showyard, there were no reports to be presented on that occasion.

The receipt was reported of a protest from Martin's Cultivator Company against the Judges' awards in the Trials of Swath Turners and Side Delivery Rakes, on the ground that such trials were not carried out in accordance with the regulations laid down by the Society, and after a statement by Mr. GREAVES (Steward of Implements), it was decided to refer the matter to the Implement Committee.

A letter was read from Mr. J. D. Key, on behalf of Sir A. C. Stepney, protesting against the award of the third prize, in Class 90, to Mr. Robert Taylor's cow, "Donside Princess," on the ground that this animal had not complied with the conditions of the class. After consideration, this protest was referred to the Stewards for investigation.

On the motion of Mr. CORNWALLIS, seconded by Mr. VICTOR CAVENDISH, it was resolved that the Seal of the Society be affixed to a form authorising the Bank of England to pay direct to the Society's Bankers, the London and Westminster Bank, St. James's Square, all interest accruing on the Society's investments in Consols.

The SECRETARY reported that the Mayor of Gloucester had attended the Show on the previous day and had tendered a formal invitation to the Society to hold the Show in 1909 at Gloucester. On the motion of Mr. HARRISON, seconded by Mr. BROCKLEHURST, it was decided to ask the Sites Committee to visit Gloucester, and to make a report on the sites available for the Show, for submission to the Council at their next meeting on July 31.

The Council approved certain alterations in the By-laws made under the Supplemental Charter of 1905, and recommended that they be submitted on the following day for the sanction of the General Meeting.

The meeting was then adjourned until 11.30 a.m. on the following day, Thursday, June 27.

## THURSDAY, JUNE 27, 1907.

At an Adjourned Meeting of the Council, held in the Council Room in the Lincoln Showyard, at 11.30 a.m., Mr. F. S. W. CORNWALLIS (Trustee) in the Chair:—

**Present:—Trustee.**—Sir John H. Thorold, Bart.

**Vice-Presidents.**—Mr. J. Bowen-Jones, Mr. Percy Crutchley, the Right Hon. A. E. Fellowes, the Earl of Northbrook, the Hon. C. T. Parker.

**Other Members of the Council.**—Mr. George Adams, Mr. Charles R. W. Adeane, Mr. T. L. Aveling, Mr. H. Dent Brocklehurst, Mr. R. G. Carden, Mr. Richardson Carr, Sir Richard P. Cooper, Bart, Mr. R. M. Greaves, Sir Gilbert Greenall, Bart., Mr. W. Harrison, Mr. J. H. Hine, Mr. A. Hiscock, Mr. R. W. Hobbs, Mr. W. F. Ingram, Mr. George Lobb, Mr. Ernest Mathews, Mr. W. A. May, Mr. C. Middleton, Mr. T. H. Miller, Mr. C. M. S. Pilkington, Mr. G. G. Rea, Mr. F. Reynard, Mr. C. C. Rogers, Mr. John Rowell, Mr. W. Scoby, Mr. E. W. Stanyforth, Mr. E. V. V. Wheeler, and Mr. C. W. Wilson

On the motion of Mr. CRUTCHLEY, seconded by the Hon. CECIL T. PARKER, it was unanimously resolved that the best thanks of the Society, for their efficient arrangements, are due, and are hereby tendered, to: The Chief

Commissioner of the Metropolitan Police, the Chief Constables of the Lincoln City and County Police, the Postmaster of Lincoln, the Manager of the Union of London and Smith's Bank, Lincoln, the Lincoln Local Brigade of the St. John Ambulance Association, &c.

On the recommendation of the STEWARDS OF IMPLEMENTS, it was resolved that the best thanks of the Society are due, and are hereby tendered, to Mr. Fred Scorer for the valuable services rendered by him in connection with the Trials of Swath Turners and Side Delivery Rakes.

Letters of thanks were also ordered to be addressed to various individuals and firms for assistance rendered in connection with the Show.

Other business having been transacted, the Council adjourned until Wednesday, July 31, 1907, at 11 a.m.

## Proceedings at General Meeting of Governors and Members,

HELD IN THE LARGE TENT IN THE SHOWYARD AT LINCOLN,

THURSDAY, JUNE 27, 1907.

THE EARL OF YARBOROUGH (PRESIDENT) IN THE CHAIR.

In addition to the presence on the platform of a number of Members of the Council, there was also present in the tent a large gathering of the general body of Members.

### President's Opening Remarks.

The PRESIDENT, in his opening remarks, expressed his pleasure at addressing such a large body of Members, because it was the first opportunity he had had of speaking in general meeting since his election as President of the Society. The weather, unfortunately, had not been very propitious on the first day, but they were all pleased to find it had been magnificent on Wednesday—quite King's weather. (Hear, hear.) He thought they would agree with him that the fact that His Majesty came all the way from London to visit their Show was one more proof of the great interest he took in everything connected with the Royal Agricultural Society. (Applause.) His first duty was to pay a tribute to the Council, Mayor, and citizens of Lincoln for the whole-hearted manner in which they had worked to make the Show a success. (Hear, hear.) No effort had been spared on their part to promote the success of the Show, which was one of the finest ever held. A great part of that was due to the manner in which they had pushed it in Lincoln. One of the great features of the Show was the horticultural tent, and all those who had visited it would agree that it was a magnificent exhibition. Those connected with gardening had assured him that it was worthy of the highest place in the records of horticulture in England. That was a very happy result of a very happy idea of the Lincoln Committee in promoting that Show. He was glad to be able to tell them that the attendance was quite enough to satisfy the most ardent supporter of the "Royal." At eleven o'clock that day 7,600 people had paid for admittance. That was far in excess of any record for the last few years at the same hour on the second half-crown day, and they could only hope that would go on and the records be good. They would agree with him that the arrangements made in the Showyard were the subject of the admiration of everybody who had attended the Show. One gentleman who was responsible for this was the Honorary Director, Sir Gilbert Greenall. He was quite sure he was voicing the feelings of all present, and every Member and well-wisher of the Society, in thanking Sir Gilbert very heartily for the magnificent way in which he had thrown his heart and soul into the work.

They would be glad to know that the Society was in a much more satisfactory financial condition than it was at this time last year. At the last Council Meeting the Chairman of the Finance Committee told them that the Society had now a reserve fund amounting to nearly 17,000*l.*, but to make their position more secure they required more Members. He was sure that with the good Show they had had this year, and the fact that they were going to a place where they were likely to have another successful Show next year, Members had every inducement to get their friends to join the Society. Before calling upon the Secretary to read the Report of the Judges of Farms, he thought it right to say that prizes in two classes of the competitions amounting to 150*l.* had been provided by Sir Richard Cooper, and the prizes in the other two classes by the Belvoir, Blankney, Brocklesby, Burton, and Southwold Hunts. Sir Richard Cooper had also borne the entire cost of the judging of these competitions. There was ample evidence from the large number of farms entered that great interest was taken in these competitions, and it was a matter for congratulation that the generosity of a Member of Council had enabled the Society to revert to a practice, abandoned some years ago, of offering prizes for farms in the district in which the Show was held.

**Farm Prize Competitions.**

The SECRETARY then read out the awards of the Judges in the Farm Prize Competitions. [*The full awards will be found on pp. 171 and 172.*]

The PRESIDENT said that, in alluding to the Farm Prizes, he had omitted to mention that all the secretarial work connected with the judging of the competitions had been carried out by Mr. Cyril Greenall, assisted by Mr. W. H. Hogg, the Manager of the Society's Experimental Farm at Woburn.

**Thanks to Mayor and Corporation.**

Mr. CORNWALLIS moved: "That the best thanks of the Society are due, and are hereby tendered, to the Mayor and Corporation of Lincoln for their cordial reception of the Society." That was a business meeting, and he hoped his brevity would not be taken as indicating in any measure the debt which the Society owed to the Mayor and Corporation of Lincoln. Lincoln was a city which was not so large in population as many of those they had visited, and therefore the strain upon it was all the greater. The city had risen to the occasion in giving to the Society a reception worthy of the city and the Society. While it was over fifty years since they were in Lincoln before, they hoped it would be nothing like that period before they found themselves again in the city. They could not but remember that there was living to-day one who was Mayor on the previous occasion when the Society visited Lincoln, and they hoped when they next came they might meet again in flourishing health both Mr. Tweed and the present Mayor.

The Rt. Hon. AILWYN FELLOWES, in seconding the resolution, said that of all the different places the Society had visited during the last few years, they had never been treated better than by the Mayor and Corporation of Lincoln. The resolution was unanimously carried.

**Thanks to Local Committee.**

Sir GILBERT GREENALL, in proposing a vote of thanks to the Lincoln Local Committee, said he did not think anybody had come into contact so much as himself with the gentlemen of the Committee, and he could give every one of them the best of characters. Nothing had been too much trouble, and anything that had been wanted had been done in a most cheerful manner. He felt he himself owed a deep debt of gratitude to them. They had given the very best support any Committee could have given.

Mr. CRUTCHLEY seconded the resolution, and it was passed unanimously.

**Suggestions of Members.**

In response to an inquiry from the Chair as to whether any Governor or Member had any remark to make or suggestion to offer for the consideration of the Council,

Mr. KENNETH J. J. MACKENZIE (S.E. Agricultural College, Wye) said he would like, as one responsible for the training of a large number of young Englishmen, to congratulate the Council on the re-institution of the Farm Prize Competitions. He thought many agriculturists around him would agree that one who had to teach systematic husbandry could not do better than give a critical account of the farming of the best farmers in England. He knew of no literature where a better account of such farming could be found than in the Reports on the Prize Farms in the past numbers of the Journal of the "Royal." He ventured to express the hope that the competitions would be continued. (Hear, hear.)

Mr. R. TINNISWOOD (Carlisle) agreed with what had fallen from the previous speaker. He did not think there was a more useful educational influence than the publication of the Reports on those farms that merited prizes. Looking to the large number of competitors this year, he hoped it was the beginning of better days for those interested in agriculture, and especially in the occupation of land. He only desired to make one suggestion, and that was that the Council should go a step further and offer prizes—a medal or something of the kind—to estate owners and managers who endeavoured to help farmers and tenants to make the best use of the land. In these days of keen competition and strict regulations as to sanitary matters and water supplies, some notice should be taken of the estate owners who met the tenants' requirements in regard to water supply, drainage, and cottage and farm buildings.

Mr. JAMES WATT (Carlisle) urged the necessity of securing the concession of reduced railway fares for exhibitors and their assistants in their journeys to the Shows. English railway companies might take a tip from the railways across the border who had souls above the making of dividends, and whose mission was to serve the community. The Scottish companies carried exhibitors and their assistants to the Highland Show at single fare for the double journey; but in England no consideration was shown to the exhibitors either as to rates or fares. He hoped the Royal Agricultural Society would go on and prosper and become greater than ever.

The PRESIDENT said he could assure Mr. Watt that the question of railway fares was a "hardy annual." Some of those present would be aware that as the result of a Conference held early in the year of representatives of Agricultural and Breed Societies, a deputation waited upon the General Managers at the Railway Clearing House on May 7 last. At any rate, the matter would again be carefully considered by the Council. With regard to the Farm Prizes, he was pleased to know that the revival of these competitions had given so much satisfaction to the general body of Members. Mr. Tinniswood's suggestion would be carefully considered.

#### EXTRAORDINARY GENERAL MEETING.

##### Amendment of By-laws.

The Ordinary Meeting having been concluded, The PRESIDENT said they would proceed to the business of the Extraordinary General Meeting, of which notice had been given to every Member of the Society. The alterations of the By-laws were designed to enable any Division, the Members of which had increased in number to the necessary extent during the first or second year of a triennial period, to obtain increased representation on the Council without waiting for the next Triennial Election for such Division. It was necessary for a formal resolution to be passed at that meeting, and he would ask the Secretary to read the actual terms of the alterations in the By-laws. These alterations had been passed by the Council on the previous day, and they were then submitted for the sanction of the General Meeting.

The following resolution, having been read by the SECRETARY, was, on the motion of the PRESIDENT, seconded by Sir JOHN THOROLD (Chairman of the Committee of Selection), unanimously adopted :—

That the following additions and alterations in the By-laws of the Society enacted under the Supplemental Charter dated April 1, 1903, be and the same are hereby sanctioned, viz. :-

1.—An additional By-law to follow the By-law at present numbered 82 in the following terms:—

"If on the first day of August in any year the number of Governors and Members entered in the Register of Governors and Members for any Division shall be such as would, if the regular election of Ordinary Members of the Council for that Division under By-law 82 were due to take place with reference to the next ensuing Annual General Meeting, entitle such Division to a greater number of Ordinary Members of Council than was elected at the preceding regular election under By-law 82, such Division shall (with reference to the next ensuing Annual General Meeting) be entitled to elect such number of additional Ordinary Members of the Council as, with the number already elected, shall make the number of Ordinary Members of the Council for that Division equal to the number prescribed by By-law 79. Ordinary Members of the Council elected under this By-law shall hold office only until the next Annual General Meeting at which under By-law 82 the Ordinary Members of the Council for that Division are to retire."

2.—The following alterations, viz. :-

In the By-law at present numbered 74 the words "to take office at such Annual General Meeting" to be substituted for the words "in the place of those vacating office" at the end of sub-clause (c).

In By-law 79 the word "an" to be substituted for the word "the" between the words "which" and "election" in the last line but one.

In By-law 85 the words "with reference to which the election is to take place" to be substituted for the words "at which the retiring members vacate office," in the tenth line.

3.—The re-numbering of the whole of the By-laws now numbered 57 to 83 inclusive including the additional By-law above sanctioned, so as to run consecutively after the By-laws enacted by the Council under the original Charter, and the necessary incidental corrections in references to those By-laws respectively.

Thanks to Chairman.

Mr. SAMUEL KIDNER said he had a very pleasant duty to perform, and that was to propose a vote of thanks to Lord Yarborough for his services in the Chair. He was sure that this resolution needed no words of his to commend it most heartily to every one present.

Mr. ROBERT FISHER seconded the resolution, which was carried unanimously.

The PRESIDENT, in reply, said that the Society was very well served indeed by its Secretary and staff. The work in connection with a great Show of that kind was very heavy, but he was quite certain that the Society in Mr. McRow and those who worked under him had a Secretary and staff who were ever ready to support the Council and the general body of Members to the fullest extent.

The meeting then terminated.

WEDNESDAY, JULY 31, 1907.

At a Monthly Council, held at 16 Bedford Square, W.C., Sir JOHN THOROLD, Bart. (Trustee), in the Chair:—

Present:—*Trustees*.—The Earl Egerton of Tatton, Lord Middleton, Lord Moreton

*Vice-Presidents*.—H.R.H. Prince Christian, K.G., Mr. J. Bowen-Jones, the Right Hon. Victor C. W. Cavendish, M.P., Mr. Percy Crutchley, the Right Hon. A. E. Fellowes, the Earl of Northbrook.

*Other Members of the Council*.—Mr. Charles R. W. Adeane, Mr. T. L. Aveling, Mr. S. N. Bankart, Mr. H. Dent Brocklehurst, Sir Richard P. Cooper, Bart., Mr. R. M. Greaves, Sir Gilbert Greenall, Bart., Mr. Joseph Harris, Mr. W. Harrison, Mr. R. W. Hobbs, Mr. J. Howard Howard, Mr. W. F. Ingram, Mr. Ernest Mathews, Mr. T. H. Miller, Mr. C. M. S. Pilkington, Mr. F.

Reynard, Mr. E. W. Shackle, Mr. H. H. Smith, Mr. R. Stratton, Mr. H. Tallent, Mr. George Taylor, and Mr. John Thornton.

The following Members of the Newcastle Local Committee were also present:—The Lord Mayor of Newcastle (Mr. J. M. Oubridge), Mr. Wm. Chrystal, Mr. J. Fitzgerald, Mr. J. D. Walker, Mr. Johnstone Wallace, and Mr. A. M. Oliver (Local Secretary).

In the absence, through ill-health, of the President, Sir JOHN THOROLD was called to the Chair, on the motion of Mr. CRUTCHLEY, seconded by Mr. BOWEN-JONES.

The minutes of the meetings of the Council, held in the Lincoln Showyard on June 26 and 27, 1907, were taken as read and approved.

Messrs. W. M. Dean, C. L. Prior, and H. R. Wilson were admitted into the Society as Governors under By-law 2, and the names of the Duke of Rutland, Admiral the Hon. T. Seymour Brand, the Right Hon. Sir Henry Aubrey-Fletcher, Bart., M.P., and Mr. J. A. James, were transferred from the List of Members to the List of Governors under By-law 9.

One hundred and seven new Members were elected under By-law 2, and the names of two Members (Capt. Galloway and Mr. George Spilman) were restored to the Register under By-law 14.

The Report of the Sites Committee having been read, an influential deputation from the City and County of Gloucester was introduced in support of the invitation to the Society to hold the Show of 1909 at Gloucester. After observations by the MAYOR OF GLOUCESTER, the MAYOR OF CHELTENHAM, Viscount ST. ALDWYN, Sir JOHN DORINGTON, and Sir NIGEL KINGSCOTE, the deputation withdrew; and on the motion of Sir GILBERT GREENALL (Honorary Director), seconded by Mr. DENT BROCKLEHURST, it was unanimously decided to accept the invitation extended by the Mayor of Gloucester, on behalf of the City and County, to hold the Society's Show at Gloucester in 1909, subject to the usual conditions of the Society being complied with.

The Report of the Finance Committee was received and adopted, and on the motion of Mr. ADEANE, seconded by Mr. CRUTCHLEY, the following resolution was unanimously agreed to:—"That in view of the desirableness of winding up as early as possible the accounts for the Lincoln Show, authority be given for the issue, during the recess, of orders upon the Society's Bankers for the payment of accounts connected with the Show."

The Report of the Committee of Selection, which intimated that the Committee had received with regret the resignation of Mr. Charles Whitehead, a Vice-President of the Society, was received and adopted. The CHAIRMAN said that the Council would, he was sure, desire to place on record the expression of their sincere regret that Mr. Whitehead was compelled, through ill-health, to resign his position on the Council, and they would doubtless wish that a letter should be written thanking him for his past services. It was resolved, on the motion of the Earl of NORTHBROOK, seconded by Mr. CRUTCHLEY: "That the Earl of Yarborough be elected a Vice-President of the Society to fill the vacancy caused by the resignation of Mr. Whitehead."

Resolutions for the amendment of the By-laws were then adopted by the Council, on the motion of the CHAIRMAN, seconded by the Earl of NORTHBROOK.

*[The text of these resolutions will be found in the proceedings of the Extraordinary General Meeting, see page xxxviii.]*

Lord MORETON presented the Report of the Education Committee, and moved: "That the best thanks of the Society be conveyed to the Earl of Yarborough and to his Lordship's forester for the valuable assistance they had afforded the Society in connection with the Forestry Exhibition, not only at Lincoln this year, but also in the past." The resolution was seconded by Mr. BOWEN-JONES, and unanimously adopted.



Consideration was given to the following suggestions made at the General Meeting in the Lincoln Showyard on June 27 last :—

- (1) "That in connection with the Competition for Farm Prizes, a medal, or something of the kind, should be offered to estate owners and managers who endeavour to help farmers and tenants to make the best use of their land." (Mr. R. TINNISWOOD.)
- (2) "That steps should be taken to induce the Railway Companies to extend the privilege of reduced railway fares to exhibitors and their assistants in their journeys to and from the Show." (Mr. JAMES WATT.)

It was decided to take no action with regard to Suggestion 1. In connection with Suggestion 2, the CHAIRMAN explained that the question of reduced railway fares was one that had been before the Council on several occasions, and that as recently as May 7 a deputation from this Society and the various Agricultural and Breed Societies of the United Kingdom had waited upon the General Managers of the various Companies to endeavour to obtain facilities similar to those suggested by Mr. Watt. The following letter had since been received from the Secretary of the Railway Clearing House :—

RAILWAY CLEARING HOUSE,  
Seymour Street, Euston Square,  
London, N.W.  
July 23, 1907.

REDUCED FARES TO SHOWS.

DEAR SIR,

The requests submitted by the deputation from the Agricultural and Breed Societies of the United Kingdom, which attended here on May 7 last, have been carefully considered by the General Managers of the Railway Companies, and I am desired to remind you that various facilities have been afforded by the Companies from time to time in the interests of Agricultural Societies, such as, for example, the return of stock and exhibits at half rates, free conveyance of men in charge of live stock, and the issue of a fare and a quarter tickets in cases where the arrangement is warranted by the importance of the Show and the number of passengers that may be expected to travel.

I may also point out that extensive cheap excursion facilities are given in connection with all the principal Agricultural Shows.

In view of these facts the Railway Companies feel that, with a very desire to meet the Agricultural and Breed Societies as far as possible, they are unable at the present time, having regard to the constantly increasing expenses of railway working, to grant any further concessions such as those indicated by the deputation.

I should mention that the statement that in Scotland return tickets are issued at single fares to the public when travelling to Shows is not altogether correct, as this is only done in one case.

Yours truly,  
(Signed) H. SMART,  
Secretary.

T. MCROW, Esq.,  
Royal Agricultural Society of England,  
16 Bedford Square, W.C.

The Society's Seal was affixed to the documents connected with the re-investment in Metropolitan Water Board "A" Stock of the sum of 1,000*l.* (previously invested in Harewood House Stock) given by Sir Walter Gilbey, Bart., in 1896 for the endowment, for a period of twenty-one years, of a Lectureship in the History and Economics of Agriculture at the University of Cambridge.

On the motion of the CHAIRMAN, seconded by Mr. STRATTON, the Secretary was authorised to affix the Seal of the Society to the agreement with the authorities of Newcastle-upon-Tyne with regard to the holding of the Show of 1908 in that city.

Other business having been transacted, the Council adjourned over the autumn recess until November 6, 1907.

## WEDNESDAY, NOVEMBER 6, 1907.

At a Monthly Council, held at 16 Bedford Square, W.C., Mr. F. S. W. CORNWALLIS (Trustee) in the Chair :—

**Present : Trustees.**—The Earl of Coventry, Earl Egerton of Tatton, Lord Middleton.

**Vice-Presidents.**—Mr. J. Bowen-Jones, Mr. Percy Crutchley, Mr. J. Marshall Dugdale, the Earl of Northbrook, the Hon. C. T. Parker.

**Other Members of the Council.**—Mr. George Adams, Mr. Charles R. W. Adeane, Mr. T. L. Aveling, Mr. S. N. Bankart, Mr. John Barker, M.P., Mr. H. Dent Brocklehurst, Mr. T. A. Buttar, Mr. R. G. Carden, Sir Richard P. Cooper, Bart., Sir H. F. de Trafford, Bart., Mr. Henry Dudding, Mr. J. T. C. Eadie, Mr. J. W. Glover, Mr. R. M. Greaves, Sir Gilbert Greenall, Bart., Mr. W. Harrison, Mr. J. H. Hine, Mr. R. J. Bayntun Hippisley, Mr. R. W. Hobbs, Mr. J. Howard Howard, Mr. W. F. Ingram, Mr. Ernest Mathews, Mr. W. A. May, Mr. T. H. Miller, Mr. T. S. Minton, Mr. Ralph Palmer, Mr. C. M. S. Pilkington, Mr. H. F. Plumpton, Mr. G. G. Rea, Mr. F. Reynard, Mr. C. C. Rogers, Mr. John Rowell, Mr. E. W. Shackle, Mr. R. Stratton, Mr. G. Taylor, Mr. A. P. Turner, Mr. E. V. V. Wheeler, and Mr. C. W. Wilson.

The following Members of the Newcastle Local Committee were also present :—Mr. Johnstone Wallace and Mr. A. M. Oliver (Local Secretary).

In the unavoidable absence, through continued ill-health, of the President, Mr. CORNWALLIS was called to the Chair, on the motion of the Earl of COVENTRY, seconded by Mr CRUTCHLEY.

The CHAIRMAN, in opening the meeting, reported the receipt of a letter from the Earl of Yarborough expressing his great pleasure at being made a Vice-President of the Society. A communication had also been received from Mr. Charles Whitehead thanking the Council for their kind expressions on his retirement from office as Vice-President.

The minutes of the last meeting of the Council, held on Wednesday July 31, 1907, were taken as read and approved.

Thirty-two duly nominated candidates were admitted into the Society as Members under By-Law 2, and the name of one Member (Mr. James Bowers, of Kershopefoot, Cumberland) was restored to the Registers under By Law 14.

The Report of the Finance Committee having been received and adopted, Mr. ADEANE mentioned that, subject to audit, the net profit on the Lincoln Show was 5,056*l.* exclusive of the 2,000*l.* allocated to the Show account from the ordinary account.

The Report of the Veterinary Committee was received and adopted, including the following resolution :—"That in the event of the promotion of legislation dealing with the question of Tuberculosis and other diseases of cattle, the Council of the Royal Agricultural Society of England is of opinion that any Regulations for dealing with this question should be issued by the Board of Agriculture and not by any other Department."

With the view of ultimately forming a powerful and representative Committee of farmers and breeders of cattle to watch the development of this question, it was unanimously resolved, on the motion of Mr. ADEANE, seconded by Mr. RICHARD STRATTON :—

"That a Committee be formed to communicate with other Societies for the purpose of watching the interests of Agriculture in view of possible legislation with regard to the Tuberculosis question."

The Committee was constituted as follows:—The Earl of Northbrook, the Hon. Cecil Parker, Mr. J. Bowen-Jones, Mr. Richardson Carr, Mr. Ernest Mathews, Mr. Claude M. S. Pilkington, Mr. Richard Stratton, and Mr. George Taylor, with power to add to their number.

[At a Meeting of this Committee, held after the adjournment of the Council on November 6, 1907, it was decided to invite the various Cattle and County Agricultural Societies to send one or two representatives to attend a meeting to be held at the Royal Agricultural Hall, Islington, in the afternoon of the Wednesday of the Southfield Cattle Show Week—viz., December 11.]

The Report of the Council to the Annual General Meeting of Governors and Members, to be held at the Royal Agricultural Hall, Islington, at 2 p.m., on Wednesday, December 11, was prepared and ordered to be issued.

The following letter was read from the Lincolnshire Agricultural Society :

St. Benedict's Square, Lincoln,  
October 12, 1907.

GENTLEMEN.—I am desired by the Council of the Lincolnshire Agricultural Society to express their thanks for the privileges your Council allowed to the Members of this Society by free admission to your Show, also on the placing of 20s. subscribers on the same terms of entry for Stock, &c., as your own Members.

I am also further to thank your Official Staff for their kindness and courtesy in every way, when arrangements by which the two Societies were engaged in the business of the Show came in contact, more particularly on the part of Sir Gilbert Greenall, the Stewards, and the Secretary.

Also to congratulate you on the complete success of your visit to Lincoln, which, however good in comparison with late years, they hope may not remain a record for long.

Yours faithfully,  
(Signed) WM. FRANKISH,  
Secretary.

To the Council of the  
Royal Agricultural Society of England.

Other business having been transacted, the Council adjourned until Wednesday, December 11, 1907, at 11 a.m.

### WEDNESDAY, DECEMBER 11, 1907.

At a Monthly Council, held at 16 Bedford Square, W.C., Mr. F. S. W. CORNWALLIS (Trustee) in the Chair :—

**Present: Trustees.**—The Earl of Coventry, Lord Middleton, Lord Moreton, Sir John H. Thorold, Bart.

**Vice-Presidents.**—The Right Hon. Victor Cavendish, M.P., Mr. Percy Crutchley, the Right Hon. A. E. Fellowes, the Earl of Jersey, G.C.B., the Earl of Northbrook.

**Other Members of the Council.**—Mr. George Adams, Mr. Charles R. W. Adeane, Mr. T. L. Aveling, Mr. S. N. Bankart, Mr. H. Dent Brocklehurst, Mr. T. A. Buttar, Mr. R. G. Carden, Mr. Richardson Carr, Sir Richard P. Cooper, Bart., Sir H. F. de Trafford, Bart., Mr. Henry Dudding, Mr. J. T. C. Eadie, Mr. R. M. Greaves, Sir Gilbert Greenall, Bart., Mr. J. Harris, Mr. W. Harrison, Mr. J. H. Hine, Mr. R. W. Hobbs, Mr. W. F. Ingram, Sir Charles V. Knightley, Bart., Mr. George Lobb, Mr. W. A. May, Mr. T. H. Miller, Mr. C. M. S. Pilkington, Mr. H. F. Plumtre, Mr. G. G. Rea, Mr. F. Reynard, the Duke of Richmond and Gordon K.G., Mr. John Rowell, Mr. W. Scoby, Mr. E. W. Shackle, Mr. H. H. Smith, Mr. E. W. Stanyforth, Mr. R. Stratton, Mr. G. Taylor, Mr. John Thornton, Mr. A. P. Turner, and Mr. E. V. V. Wheeler.

The following Members of the Newcastle Local Committee were also present: The Lord Mayor of Newcastle (Mr. W. J. Sanderson) and Mr. Johnstone Wallace.

In the unavoidable absence, through continued ill-health, of the President, Mr. CORNWALLIS was called to the Chair, on the motion of the Earl of COVENTRY.

The CHAIRMAN, in opening the meeting, reported that the Secretary had received a letter from Lord Yarborough, in which his lordship said that his health was progressing steadily and slowly.

The minutes of the last meeting of the Council, held on Wednesday, November 6, 1907, were taken as read and approved.

Lord Hastings, the Lord Mayor of Newcastle (Mr. W. J. Sanderson), and Mr. Francis A. Bevan were elected Governors under By-law 2.

Fifty-nine duly nominated candidates were admitted into the Society as Members under By-law 2, and the name of one Member (Capt. C. S. Paulet) was restored to the Registers under By-law 14

## xliv *Annual General Meeting of Governors and Members,*

The Report of the Finance Committee was received and adopted, including the Balance-sheet of the Lincoln Show, as to which an explanation was given by Mr. ADEANE, as Chairman of the Committee.

Sir Gilbert Greenall was re-appointed Honorary Director of the Society's Show, and the following gentlemen were appointed as Stewards in the various departments of the Showyard:—*Finance*: Mr. Charles R. W. Adeane, Mr. Thomas L. Aveling, Mr. Richardson Carr, and Sir Richard Cooper, Bart. *Horses*: Mr. Cyril E. Greenall and Mr. John Rowell. *Cattle*: Mr. Joseph Harris. *Sheep*: Mr. C. W. Tindall. *Pigs*: Mr. T. A. Buttar. *Dairying, Poultry and Produce*: Mr. Ernest Mathews. *Implements*: Mr. R. M. Greaves and Mr. C. M. S. Pilkington. *Forage*: Mr. G. G. Rea. *Agricultural Education Exhibition*: Mr. J. Bowen-Jones. *Refreshments*: Mr. William Harrison.

The Report of the Education Committee was received and adopted; and Mr. Bowen-Jones and Mr. Ernest Mathews were elected as representatives of the Society upon the National Agricultural Examination Board for a period of three years from January 1, 1908.

The following Standing Committees were appointed for 1908: Finance Journal and Education, Chemical and Woburn, Botanical and Zoological Veterinary, Stock Prizes, Implement, Showyard Works, Selection, and Dairy and Produce.

Other business having been transacted, the Council adjourned until Wednesday, January 29, 1908, at 11 a.m.

---

## Proceedings at the Annual General Meeting of Governors and Members

HELD AT THE ROYAL AGRICULTURAL HALL, ISLINGTON, LONDON, N.

WEDNESDAY, DECEMBER 11, 1907.

MR. F. S. W. CORNWALLIS (TRUSTEE) IN THE CHAIR.

### PRESENT:

*Trustees*.—Lord Middleton, Lord Moreton, Sir John H. Thorold, Bart.

*Vice-Presidents*.—Mr. J. Bowen-Jones, the Rt. Hon. Victor Cavendish, M.P. Mr. Percy Crutchley, the Rt. Hon. A. E. Fellowes, the Earl of Jersey, G.C.B. the Earl of Northbrook.

*Other Members of the Council*.—Mr. George Adams, Mr. C. R. W. Adeane, Mr. T. L. Aveling, Mr. H. Dent Brocklehurst, Mr. T. A. Buttar, Mr. R. G. Carden, Mr. Richardson Carr, Sir R. P. Cooper, Bart., Mr. Henry Dudding, Mr. J. T. C. Eadie, Mr. Howard Frank, Mr. J. W. Glover, Mr. R. M. Greaves, Sir Gilbert Greenall, Bart., Mr. E. A. Hamlyn, Mr. J. Harris, Mr. W. Harrison, Mr. J. H. Hine, Mr. R. W. Hobbs, Mr. J. Howard Howard, Mr. W. F. Ingram, Mr. George Lobb, Mr. Ernest Mathews, Mr. W. A. May, Mr. T. H. Miller, Mr. R. G. Patterson, Mr. C. M. S. Pilkington, Mr. H. F. Plumptre, Mr. G. G. Rea, Mr. F. Reynard, the Duke of Richmond and Gordon, K.G., Mr. John Rowell, Mr. W. Scoby, Mr. Fred. Smith, Mr. R. Stratton, Mr. George Taylor, Mr. John Thornton, Mr. C. W. Tindall, Mr. A. P. Turner, and Mr. C. W. Wilson.

*Governors*.—Mr. T. G. Benn, Mr. Martin J. Sutton, Mr. Harold Swithinbank  
*Members*.—The Rt. Hon. F. J. Savile Foljambe, Sir P. Albert Muntz, Bart. M.P., Messrs. J. F. Blackshaw, E. Bohane, T. Brigg, A. Britten, Roland Burke, Martin Burls, R. B. Burrows, Colin Campbell, T. Carrick, E. B. Chittenden

A. H. Clark, W. S. Cleverley, H. Cooch, W. A. Cox, Major P. G. Craigie, C.B., Messrs. G. G. B. Cresswell, J. J. Cridlan, W. Crosland, Alex. Cross, John Day, A. W. Dean, T. A. Dickson, W. Duthie, Douglas Ellis, F. B. Ellis, J. B. Ellis, John Evens, Robert Fisher, W. Frankish, G. Graham, E. Grasett, C. P. Hall, J. Hughes, Alex. Iles, jun., Dunbar Kelly, John Kendrick, A. H. Kingsley, J. Lambshead, T. Latham, J. S. Ledbrook, C. W. Lister-Kaye, John McLaren, Alfred Mansell, Joseph Martin, H. C. Minchin, H. F. Moore, T. S. Morgan, W. J. Morton, F. E. Muntz, E. J. B. Nesbit, J. B. Ord, T. G. Owen, W. Parlour, C. D. Parrish, Professor J. Penberthy, Messrs. Percy Percival, T. F. Plowman, R. E. Porter, T. Potter, R. H. Powell, Owen Price, W. A. Prout, E. C. Ransome, John Richards, J. Rooke, F. F. Rootham, Rev. H. M. Rowden, Messrs. W. J. Sanderson, H. M. Simmons, Dr. F. B. Skalweit, Messrs. A. J. Smith, Alfred Stanford, F. J. Steward, Garrett Taylor, H. W. Taylor, J. Herbert Taylor, B. Thirlby, R. Thirlby, F. A. Tollworthy, E. Trimen, Frederick Turner, Eldred G. F. Walker, Lieut.-Col. F. A. Walker-Jones, Messrs. A. F. T. Westrop, J. M. White, E. Whitfield, A. C. Young, &c.

Mr. CORNWALLIS, who was called to the Chair, in the absence of the President, said that his first duty was to thank the Smithfield Club and the Royal Agricultural Hall Company for kindly placing at their disposal the room in which they met that day, and he was very glad indeed to see that the novel departure of going there had resulted in such a large attendance. He was sorry to say that the serious illness which overtook their President (the Earl of Yarborough) had been of such long duration that he was still quite incapacitated from transacting public business, and they all deeply regretted that his lordship could not be in the chair that day at the end of his very successful year of office. No one could have worked more zealously and energetically for the Society than their President, and they all hoped that he might soon be restored to health. Lord Yarborough had written him the following letter from Rome:—

December 8th, 1907.

MY DEAR CORNWALLIS,—I am indeed sorry that it is impossible for me to be in my place at the general meeting on Wednesday next. My unfortunate illness has necessitated my coming abroad for the winter, and I beg you to express to the members my deep regret that circumstances over which I have no control have permitted my carrying out in only a partial manner the duties of the high office to which they appointed me. It is with the greatest regret that I ask you to make my apologies to the meeting, expressing at the same time an assurance of the warm interest I shall ever take in the welfare of the "Royal." To yourself, who have several times taken my place since my illness, as well as to Mr. McIlroy and the staff, I venture to express my indebtedness for the valuable assistance I have at all times received during my year of office, and to the members an assurance of appreciation for the honour they did me in appointing me President for this year.—Believe me, yours very truly,

(Signed) YARBOROUGH.

The first business on the agenda was to receive the Balance-sheet and Report of the auditors. As most of those present would be aware, the Society's financial year did not close until December 31, so that the current year's accounts would not be ready until the Journal was published early next year; but in order to comply with the By-laws, the Balance-sheet and accounts for 1906, as published in the last number of the Journal, were now formally presented to the meeting. What the majority of Members, however, would be most interested in were the accounts of the Lincoln Show. These accounts had been duly audited, and copies were now in their hands. The result of that most successful Show, which was honoured by a visit from H.M. The King, was a credit balance of 5,056*l.*, a profit which had only been exceeded on two previous occasions, namely, at York in 1883 and at Manchester in 1869. Moreover, there was, in addition to that 5,056*l.*, the 2,000*l.* set apart from the ordinary funds of the Society for the Show, which would make a total of 7,056*l.* to go to the Reserve Fund. It was interesting, while on the subject of the Show, first to note in passing that the recent experiments of combining with the local Agricultural Show had proved most advantageous to both parties, and they had received with gratification an expression to that effect from the

Council of the Lincolnshire Agricultural Society. The arrangements for the Show at Newcastle-upon-Tyne next year were progressing most satisfactorily and there was every indication that the Show in that city would be one of the most successful the Society has ever held. The Local Committee had been most generous in their contributions to the Prize Fund, to which they were prepared to subscribe a sum not exceeding 2,000*l.* This, he was sure would be appreciated with greater force when they saw the excellent prize sheet for the Newcastle Show, which had now been finally settled. The Far Prize Competitions—the revival of which was received with so much gratification last year—had been again instituted for farms in the district of the Show—namely, the counties of Northumberland and Durham. The Society had been able, through the generosity of one of its Members, to offer prizes amounting to 100*l.* for plans of farm buildings, particulars of which would be found in the prize-sheet to be issued shortly. For 1909 the Society had accepted the invitation of the authorities of Gloucester to hold the Show in their city. Apart from the financial result of the Lincoln Show, the most important financial matter was the completion of the sale of the Society's valuable property in Harewood House for 45,000*l.* The total result was that the financial position of the Society had much improved since the last annual meeting, and that the Reserve Fund, including investments, to-day stood at 14,000*l.*, and the 7,000*l.* to be shortly added would make the total the Reserve Fund of the Society 21,000*l.* He regretted that the total number of Members on the books was only seventy more than at the last annual meeting, and he could not help thinking that their membership was not as large as it might well be. He was glad that the suggestion made by the Members by the Secretary when sending out the Report to that meeting, that each Member should use his best endeavours to obtain at least one new subscriber, had had some result, but the matter had not yet been taken up generally as it might be. He was sure that all of those present could think of friends and acquaintances interested in Agriculture who were not yet members of the "Royal," and he would like to take the opportunity of asking them to help in the matter, as a large membership was the surest foundation on which the Society could build.

#### Adoption of Report.

Mr. J. B. ELLIS (West Barsham) said it was with much pleasure that he rose to move the adoption of the Report, as it was always a pleasure to undertake that duty when the Report was a successful one. He was sure that the efforts of the Council, and of their hard-working Secretary, had been the means of making their Show an abnormal success, and as nothing succeeded like success, there was no doubt that they would still go on and prosper. He was sure he was speaking for all the Members in expressing regret at the absence of their noble President. Nothing but ill-health would have kept him from occupying the chair on that occasion, because he had the interest of the Society so much at heart. They should all put forth their individual efforts to help raise the membership of the "Royal," and he did not think that it was a very hard matter. He believed that they had now nearly 10,000 Members, and each one of them would only get half-a-crown apiece, they would soon increase their list of subscribers.—(Laughter.)—It was very gratifying to know that they had passed through the stage of depression, and that they now had a reserve of 21,000*l.* He did not know that anything could be more gratifying than to be told that they had such a nest-egg as that.

Mr. JOHN EVENS (Burton, Lincoln), speaking as a Lincolnshire tenant farmer, had a special interest in seconding the adoption of the Report. They in Lincolnshire had been very proud to receive a visit from the Society, and they were still more proud to know that that visit had had such a splendid result. At the same time, he also shared the regret expressed by their Chairman—that they had been gaining Members all along the line during the year—that they had only a net gain of seventy Members. If they would all try to obtain a

more each it would have a very satisfactory result. Might he also express the pleasure that had been felt by the whole of the tenant-farmers in Lincolnshire at the action more than a year ago in going outside the Council to elect as their President the popular North Lincolnshire land-owner, Lord Yarborough.

The Report of the Council was then unanimously adopted.

#### Election of President.

Sir ALBERT MUNTZ moved: "That the Right Hon. Victor Cavendish, M.P., be elected President of the Society, to hold office until the next ensuing Annual General Meeting." Various qualifications were required in their President. They had had some great Presidents in the past, who had no doubt possessed the qualifications to which he referred. They required a man of great position, weight, and influence, who also took an interest in, and had a knowledge of, agriculture, and moreover they required a hard worker. He thought they had all these qualities combined in Mr. Cavendish, and he had no doubt himself that, although the Presidents of the past had possessed high qualifications, and had carried on the Society with success, they would find Mr. Cavendish equal to any of the past holders of the office. He could congratulate the Council on their success during the past year, and the Society's immensely improved position as compared with a year or two ago. He thought that with a little effort on the part of all the Members, as had already been stated by two or three speakers—and it was a very trivial matter for every Member of the Royal Agricultural Society to secure one more Member to join their ranks—they would be in a far healthier and happier position than even they were at the present time. He hoped that every Member would make up his mind to assist in strengthening the basis of the Society's operations. He only wished and hoped that during Mr. Cavendish's year of office the prosperity of the Society would be increased.

Mr. JOSEPH MARTIN (Littleport) seconded the proposition. He had known Mr. Cavendish for many years, and when he (Mr. Martin) had been on the Council and had worked with him on various occasions Mr. Cavendish had always displayed great aptitude, and he was sure that he would make a very good President.

The resolution having been carried unanimously,

Mr. CAVENDISH begged to thank them most sincerely for the very great honour they had conferred upon him by electing him to the important position of President. He could honestly say that of all the positions that an Englishman could occupy, that of being President of the Royal Agricultural Society was indeed one of the greatest that fell to his lot. He remembered with satisfaction his election to the Council some nine or ten years ago, since when he had done his utmost to make himself a useful Member of the Council, and he hoped that in the more responsible position of President he would not be found wanting. He could only appeal for the kind indulgence and generous support, not only of his colleagues upon the Council, but of all Members of that Society. He felt but ill-qualified to follow in the footsteps of many of his distinguished predecessors, but their example, and his desire to make the Society greater, would prompt him to use every endeavour he could. It might be difficult to do much to increase the power and popularity of the Society; but it had so much advanced during the last few years that they had every encouragement to persevere, and he felt certain if they all pulled together they would do something to make the Society even greater than it was before. He thanked them once more very sincerely, and he hoped that he would prove worthy of the confidence they had placed in him.

#### Election of Trustees and Vice-Presidents.

The Trustees and Vice-Presidents were then on a show of hands re-elected for the ensuing year.

## xlviii *Annual General Meeting of Governors and Members,*

### **Election of Auditors.**

Mr. ROBERT FISHER (Leconfield, Beverley) then moved that the best thanks of the meeting be tendered to Mr. Jonas M. Webb, Mr. Hubert J. Greenwood, and Mr. Newell P. Squarey for their services as Auditors during the past year, and that they be re-elected to hold office until the next ensuing annual general meeting. He could only hope that next year they would have an even more satisfactory Report to make than that presented that day.

Mr. FRANKISH, in seconding the motion, said that their Auditors were very capable men, and they could not do better than re-elect them.

The resolution was then carried unanimously.

### **Election of Council.**

The CHAIRMAN stated that the necessary steps had been taken to fill the vacancies on the Council in the representation of the districts in Group B, the Members of which retired by rotation; and he, as representing the President, had to formally report to the Annual General Meeting the names and addresses of the Ordinary Members of Council who had been elected by the fifteen divisions of that Group, and in Lincolnshire and Staffordshire, in order that the meeting might, in accordance with the By-laws, "take cognisance" of their election.

These names and addresses were as follows:—

Bankart, S. N., Hallaton Hall, Uppingham (Rutland).  
De Trafford, Sir H. F., Bart., Hill Crest, Market Harborough (Leicestershire).  
Frank, Howard, 9 Conduit Street (London).  
Hamlyn, Ernest A., Oakdale, Ockley (Surrey).  
Hine, John Henry, Pomphlett Farm, Plymstock, Plymouth (Devonshire).  
Mathews, Ernest, Little Shardiloes, Amersham (Buckinghamshire).  
May, William A., 3 Wellington Street, Strand (London).  
Middleton, Christopher, Vane Terrace, Darlington (Durham).  
Minton, Thomas S., Montford, Shrewsbury (Shropshire).  
Nocton, William, Langham Hall, Colchester (Essex).  
‡Patterson, R. G., Acton Hill, Stafford (Staffordshire).  
Pilkington, Claude M. S., Wollaton, Nottingham (Nottinghamshire).  
Rogers, C. Coltman, Stanage Park, Brampton Bryan (South Wales).  
Smith, Fred., Woodbridge (Suffolk).  
Smith, Henry Herbert, Bowood, Calne (Wiltshire).  
Stanyforth, E. Wilfrid, Kirk Hammerton Hall, York (W. Riding Yorkshire).  
Thornton, John, 7 Princes Street, Hanover Square (London).  
‡Tindall, C. W., Wainfleet, S.O. (Lincolnshire).  
Turner, Arthur P., The Leen, Pembridge (Herefordshire).

‡ Additional members elected under By-law 83.

### **Suggestions of Members.**

In response to the usual inquiry from the Chair as to whether any Governor or Member had any remark to make or suggestion to offer that might be referred to the Council for consideration,

Mr. ERNEST A. HAMLYN (Ockley), referring to the remarks of several previous speakers as to increasing the membership of the Society, suggested the formation of a proper recruiting Committee. They had Committee of the Council for various business matters, and he thought that four or five men should devote themselves specially to membership. He would therefore suggest for the consideration of the Council at their next monthly meeting that a special Committee should be appointed for that purpose. There was another matter on which he would like to say a few words, and that was the importation of meat. He believed that 80 to 90 per cent. of the meat sold at Deptford and Smithfield markets came from abroad. The result was that although a great many butchers throughout London stated that they sold only the primest English meat, he very much doubted if their customers could be certain of getting it. He thought that the wives of poor men should be certain of obtaining English meat. He would suggest that this matter should also be brought up at the next Council meeting, and that they should consider the advisability of approaching the Board of Agriculture to request them to take measures to compel butchers who sold foreign meat to exhibit a notice to that effect.



Mr. H. M. SIMMONS (Hailsham) suggested that in future the Judges at the Show should not be acquainted with the names of the owners of the animals that came before them, as was done at the present time. He would also suggest that the herdsmen be not allowed to bring out their own cattle to be judged, but that they should be changed about, the Shorthorn men taking out, say, the Sussex animals, and vice-versa.

Mr. CHARLES P. HALL (Woburn) ventured to suggest to the Council, with reference to the very important question of increasing the number of Members of the Society, that they might find some very useful recruiting sergeants in the secretaries of the local agricultural and kindred societies. Those gentlemen were, from the nature of the offices they held, fully acquainted with the affairs and names of those interested in agriculture in their counties, and he thought that if the Council could see their way to offer those secretaries some privilege or inducement to obtain new Members, it would work out very well with their existing duties, and the result would be satisfactory to the Society. He ventured to mention this as an adjunct to the suggestion already made that every Member of the Society should get another Member.

Mr. ELDRED G. F. WALKER (Bristol) said that he would like once more, on behalf of the West of England cider growers, to draw the attention of the Council to the question of cider. The Society's analyst tested the exhibits for preservatives, but when the Judge went through, none of the samples, as far as they could see, were disqualified. As farmers and as judges of cider they appreciated the taste, and in tasting they found ciders which appeared greatly superior to those taking prizes. At the time they thought that the judge had made a great mistake, but subsequently they were told that the exhibits had not passed the chemist. In his opinion the Royal Agricultural Society's chemist was inferior to none, and he thought that the Council should not be ashamed to put upon the bottles a statement that the exhibits had been disqualified for preservatives. They also wanted two Judges for cider, as he would defy any Judge, after tasting a sample containing saccharine, to properly taste the next four or five samples. Furthermore, to show their earnestness in the matter, he and one or two more farmers would be prepared, when the Society went to Gloucester, to give a champion prize of a moderate amount if two Judges were appointed. He might say that he was not an exhibitor, and he did not wish to be.

The CHAIRMAN said that a note had been taken of all the suggestions which had been made, and that they would receive the attention of the Council in due course.

#### Vote of Thanks to Chairman.

Mr. MARTIN J. SUTTON had the honour to propose a vote of thanks to their Chairman. He had had the privilege of sitting for some years on the Council with Mr. Cornwallis, and he could say that during that time he knew of no Member of Council who had put his back into the work as Mr. Cornwallis had. Since then, however, they had very special reason to pass that vote of thanks with enthusiasm, inasmuch as Mr. Cornwallis had been the Chairman who had had to deal with the sad state of things of the Society, and who, with the great help of Sir Richard Cooper, Sir Gilbert Greenall, and others, had pulled the Society out of the rut and set it going again. They all wished unanimously to express their thanks to their Chairman, not only for his conduct that day, but for all he had done for the Society.

Mr. JOHN MCLAREN (Leeds) said he had the greatest pleasure in seconding the motion which had been so ably proposed by Mr. Martin Sutton. They all recognised the valuable work done by their Chairman, and would, he was sure, receive this motion most enthusiastically. He would like to say before he sat down that although they were making money and had a fine Reserve Fund, he hoped they would be careful and husband their resources. Although they had had a good year at Lincoln, and would doubtless have a good year at

1 *Annual General Meeting of Governors and Members.*

Newcastle, and again at Gloucester, they ought to fortify themselves, so that they might be able to visit places where they would know they would not make a profit, and also to guard against the series of bad years which might come again. They would have plenty of friends to advise them how to dispose of their money, but he would like to advise the Council, as an implement exhibitor—who did not receive much, and who did not want anything—to keep their eyes upon those cattle men and the Breed Societies, and not to be persuaded into giving too handsome prize lists at their Shows, but rather to strengthen the reserve, even at the expense of a little discontent among the exhibitors of cattle—and perhaps of cider. (Laughter.)

The SECRETARY then put the motion, which was carried with acclamation. Mr. CORNWALLIS, in response, said he had only to thank them very much for the kind manner in which they had just passed that vote of thanks. In one way it was a great pleasure to him to occupy the chair at a meeting which had passed off with such pleasing unanimity, but, on the other hand, he very deeply regretted that Lord Yarborough, who had thrown so much energy into the work of the Society during the past year, had been unable to preside. He was sure it would be their wish that he should convey to the retiring President their great appreciation of his services during the year, to which expressions had been given by the various speakers, and so cordially endorsed by the meeting. They would, one and all of them, share the feeling that in handing over to Mr. Victor Cavendish the onerous duties of President of the Society, they could rest assured that they would be perfectly safe. He wished Mr. Cavendish a very prosperous year of office, and hoped that next year he would be in a position to report a good profit on the Newcastle Show, and that the general finances of the Society were in a sound and flourishing condition.

---

# LINCOLN MEETING,

JUNE 25 TO 29, 1907.

## PRESIDENT :

**THE EARL OF YARBOROUGH, Brocklesby Park, Lincolnshire.**

## OFFICIALS :

### Honorary Director.

SIR GILBERT GREENALL, Bart., Walton Hall, Warrington.

### Stewards of Live Stock.

FREDERICK REYNARD, Sunderlandwick, Driffield.

JOHN ROWELL, Bury, Huntingdon.

W. F. INGRAM, 2 St. Andrew's Place, Lewes.

E. VINCENT V. WHEELER, Newnham Court, Tenbury.

J. MARSHALL DUGDALE, Llwyn, Llanfyllin, S.O.

### Stewards of Implements.

R. M. GREAVES, Wern, Portmadoc.

CLAUDE M. S. PILKINGTON, Wollaton, Nottingham.

### Steward of Dairying and Poultry.

ERNEST MATHEWS, Little Shardeloes, Amersham, Bucks.

### Steward of Forage.

JOHN EVENS, Burton, near Lincoln.

### Steward of Veterinary Examination.

CYRIL E. GREENALL, Willoughby Hall, Grantham.

### Steward of Refreshments.

WILLIAM HARRISON, Hall House, Leigh, Lancs.

### Steward of Agricultural Education and Forestry Exhibition.

J. BOWEN-JONES, St. Mary's Court, Shrewsbury.

### Stewards of Finance.

CHARLES R. W. ADEANE, Babraham Hall, Cambridge.

THOMAS L. AVELING, Boley Hill House, Rochester.

RICHARDSON CARR, Estate Office, Tring Park, Herts.

SIR RICHARD P. COOPER, Bart., Shenstone Court, Lichfield.

### Surveyor.

J. R. NAYLOR, F.R.I.B.A., Smith's Bank Chambers, Derby.

### Secretary.

THOMAS MCRROW, 16 Bedford Square, London, W.C.

## JUDGES OF IMPLEMENTS.

### Swath Turners and Side Delivery Rakes.

SIR FRANCIS E. WALKER, Bart., Swansfield House, Alnwick.

JOSHUA BALL, Southworth Hall, Warrington.

### Miscellaneous Implements entered for Silver Medals.

THOMAS STIRTON, Rendlesham Estate Office, Woodbridge.

JAMES YOUNGER, Burradon Farm, Annitsford, Newcastle-on-Tyne.

## JUDGES OF STOCK, &amp;c.

(As finally corrected.)

## HORSES.

**Hunters.**—Classes 1-10, and 38-44 ; and  
**Polo Ponies.**—Classes 11-15 and 45.

Capt. C. FETHERSTONHAUGH, Bracklyn, Killucan.

JAMES HUTCHINSON, Manthorpe Lodge, Grantham.

**Cleveland Bays.**—Classes 16-18 ; and  
**Coach Horses.**—Classes 19-21.

F. WILSON-HORSFALL, Potto Grange, Northallerton.

**Hackneys.**—Classes 22-31 ; **Hackney Ponies.**—Classes 32-35 ; and **Harness Horses.**—Classes 46-58.

C. EDWARD E. COOKE, Bygrave House, Baldock.

ARTHUR FEWSON, The Old Hall, Hedon, Hull.

**Shetland Ponies.**—Classes 36 and 37.

R. BRYDON, The Dene, Seaham Harbour.

**Shires.**—Classes 59-67.

W. HOWKINS, Hillmorton Grounds, Barby Road, Rugby.

JOHN NIX, Stud Farm, Alfreton.

**Clydesdales.**—Classes 68-74.

JAMES WEIR, Sandilands, Lanark.

**Suffolks.**—Classes 75-79.

H. W. PACKARD, Over Hall, Shotley, Ipswich.

**Draught Horses.**—Classes 80 and 81.

W. HOWKINS, Hillmorton Grounds, Barby Road, Rugby.

JAMES WEIR, Sandilands, Lanark.

## ASSES.

Classes 82 and 83.

Col. R. GILCHRIST, Montague House, Surbiton Hill.

## CATTLE.

**Shorthorns.**—Classes 84-93.

C. M. CAMERON, Balnakeyle, Munloch.

A. S. GIBSON, The Elms, Ruddington, Nottingham.

**Dairy Shorthorn Cows and Heifers.**—Classes 94-96.

BENJAMIN READ, Church Farm, Car Dursley.

**Lincolnshire Red Short-horns.**—Classes 98-108.

E. H. CARTWRIGHT, Keddington Grange, Louth.

PETER DUNN, Pasture House, Sigglethorne, Hull.

**Herefords.**—Classes 110-115.

THOMAS MORRIS, Weston Court, Pembrokeshire.

H. W. TAYLOR, Showle Court, Lebury.

**Devons.**—Classes 116-119.

F. J. MERSON, Farringdon, North Petherton, Bridgwater.

**South Devons.**—Classes 120 and 121

EDWARD CORNISH, East Charleton, Kingsbridge.

**Sussex.**—Classes 123-128.

D. D. CRAWFORD, Nonington, Dover.

**Welsh.**—Classes 129-131.

THOMAS ROBERTS, Aber, Bangor.

**Red Polled.**—Classes 132-137.

D. A. GREEN, Fingringhoe Hall, Colchester.

GARRETT TAYLOR, Trowse House, Norwich.

**Aberdeen-Angus.**—Classes 139-144.

JAMES COEY, Ardeen, Larne.

G. J. WALKER, Portlethen, Aberdeen.

**Galloways.**—Classes 145-148.

W. STROYAN, Culcaigrie, Twynholm.

**Highland.**—Classes 149-152.

JAMES CAMPBELL, Tullich, Killin.

**Ayrshires.**—Classes 153 and 154.

R. MCKINLAY, Hillhouse, Sandilands, Lanark.

**Jerseys.—Classes 156-162.**

W. ADAMS, Woodside, Loughton.  
J. H. SHORE, Whatley House, Frome.

**Guernseys.—Classes 164-168.**

CALEB BARFOOT Lake, Bishopstoke,  
Hants.  
J. D. TOOGOOD PARSONS, Manor  
View, Rusbhall, Tunbridge Wells.

**Longhorns.—Classes 170-173.**

WILLIAM SHAW, Jun., Fradley,  
Lichfield.

**Kerry and Dexter.—Classes 175-182.**

H. D. D. BETTERIDGE, Drayton,  
Woodstock Road, Summertown,  
Oxford.  
JOHN B. ROSS, Estate Office, Whitney-  
on-Wye.

**SHEEP.**

**Oxford Downs.—Classes 186-189.**

H. OVERMAN, Kipton House, Weasen-  
ham St. Peter.

**Shropshires.—Classes 190-196.**

CHARLES COXON, Elford Park, Tam-  
worth.  
R. F. H. WHITE, Aghavoe Grange,  
Ballacolla, Abbeyleix.

**Southdowns.—Classes 197-202.**

W. BROWN, Challoners, Rottingdean,  
Brighton.  
ALLAN COOPER, Norton, Bishop-  
stone, Lewes.

**Hampshire Downs.—Classes 203-207.**

H. LAMBERT, Babraham, Cambridge.  
J. PAIN, Borough, Micheldever.

**Suffolks.—Classes 208-213.**

J. C. DAWSON, Nacton, Ipswich.

**Dorset Horn.—Classes 214-217.**

W. A. JOHNSON, Stafford Park,  
Piddletown, Dorchester.

**Eyelands.—Classes 218-220.**

H. W. TAYLOR, Showle Court,  
Ledbury.

**Kerry Hill.—Classes 221-224.**

RICHARD MORGAN, Snowfield, Kerry,  
Newtown.

**Lincolns.—Classes 225-234.**

R. FISHER, Leconfield, Beverley.  
R. WRIGHT, Nocton Heath, Lincoln.

**Leicesters.—Classes 235-238.**

H. T. ALLISON, Stanghow, Boosbeck,  
S.O.

**Cotswolds.—Classes 239-242.**

DAVIS BROWN, Marham Hall, Down-  
ham Market.

**Border Leicesters.—Classes 243-245.**

J. K. SMITH, Leaston, Upper Keith.

**Kent or Romney Marsh.—  
Classes 246-250.**

F. DE B. COLLARD, Minster Abbey,  
Ramsgate.

**Wensleydales.—Classes 251-253.**

T. JACKSON, Netherbeck, Carnforth.

**Devon Long Wool.—Classes 254-256.**

F. J. MERSON Farringdon, North  
Petherton, Bridgwater

**South Devons, and Dartmoors—  
Classes 257-260.**

E. CORNISH, East Charleton, King-  
bridge.

**Exmoors.—Classes 261 and 262.**

JAMES YAPP, Winsford, Dulverton.

**Cheviots.—Classes 263 and 264.**

J. K. SMITH, Leaston, Upper Keith.

**Lonks and Herdwicks.—Classes 265-268.**

J. C. ASHWORTH, Overtown, Cliviger,  
Burnley.

**Welsh Mountain.—  
Classes 269 and 270.**

THOMAS ROBERTS, Aber, Bangor.

**Black-faced Mountain.—  
Classes 271 and 272.**

JAMES CAMPBELL, Tullich, Killin.

**PIGS.**

**Large Whites.—Classes 273-277.**

Col. F. A. WALKER-JONES, The Manor  
House, Burton, Westmorland.

**Middle Whites.—Classes 278-282.**

W. T. HALL, Highclere Farm,  
Newbury.

**Tamworths.—Classes 283-287.**

D. W. PHILIP, The Redlands,  
Whitacre, Birmingham.

**Berkshires.—Classes 288-292.**

J. LAWRENCE, Stall Pitts Farm,  
Shrivenham.

**Large Blacks.—Classes 293-297.**

C. L. HANCOCK, The Manor House,  
Cotthelstone, Bishops Lydeard.

**Lincolnshire Curly-coated.—  
Classes 298-301.**

T. P. HORN, Elm Grange, East  
Heckington, Boston.

**POULTRY.****Classes 302-388.**

Dr. E. S. JACKSON, Carnforth.

JOHN SAUL, Halton, Lancaster.

CLEM WATSON, 77 Paddock Road,  
Bushey.

**PRODUCE.****Butter.—Classes 389 and 390.**

JOHN BENSON, The Buxton Dairy,  
Dale Road, Buxton.

**Cheese.—Classes 391-396.**

JOHN PAKEMAN, Chellaston, Derby.

**Cider and Perry.—Classes 397-400.**

JOHN WATKINS, Foley Lodge, Foley  
Street, Hereford.

**Wool.—Classes 401-410.**

Dr. F. H. BOWMAN, 4 Albert Square,  
Manchester.

ARTHUR WHITEHEAD, Bradford.

**Hives and Honey.—Classes 411-436.**

W. BROUGHTON CARE, 8 Henrietta  
Street, Covent Garden, London.

r. J. CRIBB, Sandrock House, Retford.

A. G. PUGH, Beech House, Queen's  
Road, Beeston, Notts.

r I. WESTON, Dorchester Road, Hook,  
Hants.

**COMPETITIONS.****Jumping.**

SIR R. P. COOPER, Bart., Shensto  
Court, Lichfield.

JAMES HUTCHINSON, Manthor  
Lodge, Grantham.

J. M. RICHARDSON, Edmonthor  
Hall, Oakham.

R. C. SWAN, Rockcliffe Park, Da  
lington.

ROMER WILLIAMS, Newnham Ha  
Daventry.

THOMAS WILSON, Riseholme, Lincol

**Pace and Action.**

ROMER WILLIAMS, Newnham Ha  
Daventry.

**Horse-shoeing.**

F. W. WRAGG, F.R.C.V.S., 17 Chur  
Lane, Whitechapel, E.

JOHN THIRTLE, R.S.S., 109 St. Alba  
Avenue, Bedford Park, W.

**FARMS.****Classes 1 and 3.**

T. H. HUTCHINSON, Manor Hou  
Catterick.

ARTHUR STRETTON, Manor Hou  
Sibthorpe.

**Classes 2 and 4.**

R. B. BURROWS, Leadenham, Lincol  
ROBERT FISHER, Leconfield, Beverle

**VETERINARY INSPECTORS.**

JOHN MALCOLM, F.R.C.V.S., Hollid  
Street Wharf, Birmingham.

W. S. CARLESS, M.R.C.V.S., Th  
Butts, Worcester.

CHARLES HARTLEY, F.R.C.V.S.,  
Friars' Lane, Lincoln.

HENRY G. LEPPER, M.R.C.V.S.,  
Aylesbury.

Professor J. MACQUEEN, F.R.C.V.S.  
Royal Veterinary College, Camd  
Town, N.W.

HARRY MOORE, M.R.C.V.S., Workso  
H. C. REEKS, F.R.C.V.S., Spalding.

C. W. STANLEY, M.R.C.V.S., Melt  
Mowbray.

F. W. WRAGG, F.R.C.V.S., 17 Chur  
Lane, Whitechapel, E.

# AWARDS OF PRIZES AT LINCOLN, 1907.

## ABBREVIATIONS.

I., First Prize. II., Second Prize. III., Third Prize. IV., Fourth Prize.  
R. N., Reserve Number. H. C., Highly Commended.

**N.B.**—The responsibility for the accuracy of the description or pedigree, and for the eligibility to compete of the animals entered in the following classes, rests solely with the Exhibitors.

Unless otherwise stated, each Prize Animal in the Classes for Horses, Cattle, Sheep, and Pigs was "bred by Exhibitor."

## HORSES.

### BREEDING CLASSES.

#### Hunters.

- Class 1.—Hunter Colts or Geldings, foaled in 1906.**  
[8 entries, 1 absent.]
- No. in Catalogue.**
- 7 I. (£15).—W. B. SWALLOW, Wootton Lawn, Ulceby, for *Recruit*, brown colt; s. Squadron Leader, d. Countess by Knight Templar.
- 4 II. (£10).—E. W. ROBINSON, Brookleigh, Esher, for *Collar Stud*, bay colt; s. Collar, d. Gulden.
- 1 III. (£5).—W. & J. A. CHENEY, Gidding Grove, Peterborough, for bay colt; s. Bachelor 41.
- 8 R. N. & H. C.—J. HAROLD WATSON, Green Hill, Kidderminster, for *Comedian*.
- Class 2.—Hunter Geldings, foaled in 1905.** [10 entries, 1 absent.]
- 12 I. (£15).—R. L. FENWICK, The Cottage, Wymondham, Oakham, for *Zealot*, chestnut; s. *Whisperer*, d. *Zeylious by Zeal*.
- 18 II. (£10).—F. B. WILKINSON, Cavendish Lodge, Edwinstowe, Newark, for *His Grace*, chestnut, bred by Mr. Waddington, Cliffriston, Newark; s. *Erskine*, d. *Madge*.
- 9 III. (£5).—H. A. CHOLMONDELEY, Sledmere, York, for *Aeronaut*, chestnut; s. *Pax*, d. *Cigarette by Gaston*.
- 16 R. N. & H. C.—J. L. NICKISSON, Hinton Manor, Swindon, for *Ensign*.
- Class 3.—Hunter Geldings, foaled in 1904.** [14 entries none absent.]
- 31 I. (£15).—F. B. WILKINSON, Cavendish Lodge, Edwinstowe, Newark, for *Expert*, bay, bred by Payne Galway, Bakewell; s. *Methuen*.
- 21 II. (£10).—W. & J. A. CHENEY, Gidding Grove, Peterborough, for *Nimrod*, chestnut, bred by Mr. Hanson, Northolme, Gainsborough; s. *Travelling Lad*, d. *Re-reaction*.
- 25 III. (£5).—EDWARD HODGSON, The Hollows, Bridlington, for *Dignity*, chestnut, bred by J. O'Hanlon, Naas, Co. Kildare; s. *Fitz-Clifden*, d. *by Ascetic*.
- 30 R. N. & H. C.—THE EXECUTRIX OF THE LATE JONAS WEBB, for *Andreas*.
- Class 4.—Hunter Fillies, foaled in 1906.** [14 entries, 1 absent.]
- 35 I. (£15, & Champion.<sup>1</sup>)—F. G. COLMAN, Nork Park, Ermsom Downs, for chestnut, bred by C. Kelway Bamber, Horley; s. *Royal Mask*, d. *Homely Lass* 1907 by *Homely*.
- 46 II. (£10).—F. B. WILKINSON, Cavendish Lodge, Edwinstowe, Newark, for bay, bred by E. H. Quibell, Newark; s. *Worsthorn*, d. *by Cyclops*.
- 33 III. (£5).—H. D. ADDEY, Claythorpe Manor, Alford, for *Kipper* 1901, bay; s. *Master Bob* 3446, d. *Mrs. Kiplin* 3479 by *Rameses*.
- 41 R. N. & H. C.—LORD MIDDLETON, Bird-sall House, York, for *Scalpay*.

<sup>1</sup> Gold Medal, value £10 10s., given by the Hunters' Improvement Society for the best Hunter Filly in Classes 4, 5 and 6, not exceeding three years old, which is registered or entered in the Hunter Stud Book.

[Unless otherwise stated, each prize animal named below was "bred by exhibitor."]

**Class 5.—Hunter Fillies, foaled in 1905.** [8 entries, 1 absent.]

- 50 I. (£15, & R. N. for Champion.<sup>1</sup>)—EDWARD HODGSON, The Hollows, Bridlington, for *Maib*, bay; s. *Pax*, d. *Faithful by Gooseberry*.  
 49 II. (£10)—W. & J. A. CHENEY, Gidding Grove, Peterborough, for *Lady Mary*, bay; s. *Forced March*, d. *Ladysmith 2252 by Old Coin*.  
 54 III. (£5)—W. B. SWALLOW, Wootton Lawn, Ulceby, for *Alpha*, bay; s. *Wales*, d. *Tugela 2544 by Anklebiter*.  
 53 R. N. & H. C.—J. H. SEDGLEY, Church Langton, Market Harborough, for *Clementine*.

**Class 6.—Hunter Fillies, foaled in 1904.** [4 entries.]

- 56 I. (£15)—MAJOR LESLIE RENTON, M.P., Naseby Hall, Rugby, for *Success*, chestnut, bred by J. L. Nickisson, Hinton Manor, Swindon; s. *Enterprise*, d. *Socks*.  
 57 II. (£10)—R. W. RIGGALL, Ulceby Glebe, Alford, for brown, bred by F. B. Wilkinson, Cavendish Lodge, Edwinstowe, Newark; s. *Havoc*, d. *Nora*.  
 58 III. (£5)—GILBERT ROBINSON, Brixworth Hall, Northampton, for *Red Lass*, chestnut, bred by Edward Hodgson, The Hollows, Bridlington; s. *Red Prince 2nd*, d. *Faithful by Gooseberry*.  
 55 R. N. & H. C.—W. D. MARGRAVE, Atterby, Kirton Lindsey, for *Lady Primrose*.

**Class 7.—Hunter Mares, with Foals at foot, up to 14 stone.**

[10 entries, 1 absent.]

- 63 I. (£15, & R. N. for Champion.<sup>2</sup>)—J. A. MULLENS, Barrow Hills, Longcross, for *Glow-worm*, black brown, foaled 1897 [foal by *Glenrossal*], bred by W. Irwin Pallas, Kilmeady, Co. Limerick; s. *Traverser 2nd*, d. by *Hercules*.  
 68 II. (£10, & R. N. for Special.<sup>3</sup>)—F. B. WILKINSON, Cavendish Lodge, Edwinstowe, Newark, for *Rosalinda 2792*, brown, foaled 1899 [foal by *Limerick 48*], bred by the late A. J. Brown, Marr Grange, Doncaster; s. *Discord*, d. *Roseolin by Rosicrucian*.  
 66 III. (£5)—E. W. ROBINSON, Brookleigh, Esher, for *Golden Leaf 2398*, chestnut, foaled 1894 [foal by *Riverstown*], bred by M. Dobson Peacock, Manor House, Middleham, R.S.O.; s. *Tertius*, d. *Golden Fringe by Discord*.  
 67 R. N. & H. C.—W. B. SWALLOW, Wootton Lawn, Ulceby, for *Tugela*.

**Class 8.—Hunter Mares, with Foals at foot, up to more than 14 stone.**

[8 entries, none absent.]

- 73 I. (£15, & Champion.<sup>2</sup>)—J. A. MULLENS, Barrow Hills, Longcross, for *Everlasting*, bay, foaled 1899 [foal by *Glenrossal*], breeder unknown.  
 73 II. (£10, and Special.<sup>3</sup>)—OLIVER QUIBELL, Shalem Lodge, Newark, for *Diana*, brown, foaled 1894 [foal by *Ocean Wave*], breeder unknown.  
 69 III. (£5)—MARMADUKE FURNESS, Cundall Manor, York, for *Laurista 1090*, black brown, foaled 1899 [foal by *Squadron Leader*], bred by T. F. Sparrow, Williamstown, Kells; s. *Lord Marmion*, d. *Laura by Charley 12th*.  
 74 R. N. & H. C.—E. W. ROBINSON, Brookleigh Esher, for *Lady Sheldrake*.

**Class 9.—Hunter Colt Foals, the produce of mares exhibited in Classes 7 or 8.**

[4 entries, none absent.]

- 79 I. (£10)—J. A. MULLENS, Barrow Hills, Longcross, for bay; s. *Glenrossal*, d. *Glow-worm by Traverser 2nd*. [Exhibited with No. 63 in Class 7.]  
 78 II. (£5)—EDWARD HODGSON, The Hollows, Bridlington, for bay; s. *Rob O'Neill*, d. *Princess May by Southampton*. [Exhibited with No. 62 in Class 7.]  
 77 III. (£4)—MARMADUKE FURNESS, Cundall Manor, York; s. *Squadron Leader*, d. *Laurista 1090 by Lord Marmion*. [Exhibited with No. 69 in Class 8.]

**Class 10.—Hunter Filly Foals, the produce of mares exhibited in Classes 7 or 8.**

[9 entries, none absent.]

- 83 I. (£10)—J. A. MULLENS, Barrow Hills, Longcross, for bay; s. *Glenrossal*, d. *Everlasting*. [Exhibited with No. 72 in Class 8.]  
 86 II. (£5)—E. W. ROBINSON, Brookleigh, Esher, for *Easter Egg*, bay; s. *Riverstown*, d. *Golden Leaf 2896 by Tertius*. [Exhibited with No. 66 in Class 7.]  
 88 III. (£4, & Special.<sup>4</sup>)—W. B. SWALLOW, Wootton Lawn, Ulceby, for *Lady Diana*, bay; s. *Squadron Leader*, d. *Countess*. [Exhibited with No. 76 in Class 8.]  
 1. R. N. & H. C.—JOHN COOPER, Brook Hill House, East Haddon, for *Miss Gruden*.  
 2. R. N. for Special.<sup>4</sup>—W. B. SWALLOW, for *Tulip*.

Gold Medal, value £10 10s., given by the Hunters' Improvement Society, for the best Hunter Filly in Classes 4, 5, and 6, not exceeding three years old, which is registered or entered in the Hunter Stud Book.

<sup>2</sup> Gold Medal, value £10 10s., given by the Hunters' Improvement Society, for the best Hunter Mare four years and upwards, in Classes 7 and 8 and 38-44.

<sup>3</sup> Special Prize of £10 given by the Lincolnshire Agricultural Society, for Members of that Society only, for the best Hunter Mare in Classes 7 and 8.

<sup>4</sup> Special Prize of £5 given by the Lincolnshire Agricultural Society, for Members of that Society only, for the best Hunter Foal in Classes 9 and 10.



[Unless otherwise stated, each prize animal named below was "bred by exhibitor."]

### Polo and Riding Ponies.

- Class 11.—Polo and Riding Pony Stallions, foaled in or before 1904, not exceeding 14 hands 2 inches.** [5 entries, none absent.]
- 94 I. (£15, & Champion.<sup>1</sup>)—STEPHEN MUMFORD, Stud Farm, Moreton Morrell, Warwick, for Spanish Hero 372, brown, foaled 1898, bred by J. G. Mosenthal; s. Kilwarlin 658, d. Spanish Maiden by Merry Hampton.
- 92 II. (£18, & R. N. for Champion.<sup>1</sup>)—VICE-ADMIRAL BRIDGEMAN, Copgrove Hall, *vid* Leeds, for Carnival 172, grey, foaled 1893, bred by Mohamed Ben Mohamoud, Oran, Algeria.
- 93 III. (£8.)—DUNBAR KELLY, Coombe, Kingston-on-Thames, for Mountain Ash 298, chestnut, foaled 1898, bred by W. Ash, Narraghamore, Ballymore; s. Carnage, d. Cecropia by Cecrops.
- 90 R. N. & H. C.—JOHN BARKER, M.P., Bishop's Stortford, for Right For'ard.
- Class 12.—Polo and Riding Pony Colts, Fillies, or Geldings, foaled in 1906, not exceeding 13 hands 3 inches.**<sup>2</sup> [8 entries, none absent.]
- 95 I. (£16, & R. N. for Champion.<sup>2</sup>)—JOHN BARKER, M.P., The Grange, Bishop's Stortford, for Miss Wembley, bay filly; s. Sandiway, d. Wembley 1469.
- 96 II. (£8.)—JOHN BARKER, M.P., for Re-Echo, bay gelding; s. Bold Marco, d. Echo by St. Lawrence.
- 97 III. (£5.)—TRESHAM GILBEY, Whitehall, Bishop's Stortford, for Mayleaf, brown filly, bred by John Barker, M.P., Bishop's Stortford; s. Bold Marco, d. Ivy.
- 99 R. N. & H. C.—THE HON. MRS. IVES, Moyns Park, Birdbrook, Essex, for Babe.
- Class 13.—Polo and Riding Pony Colts, Fillies, or Geldings, foaled in 1905, not exceeding 14 hands 1 inch.**<sup>3</sup> [9 entries, 1 absent.]
- 104 I. (£16.)—JOHN BARKER, M.P., The Grange, Bishop's Stortford, for Ruby, bay gelding; s. Sandiway, d. Sapphire 1448 by Pet Fox.
- 100 II. (£8.)—THE KEYNSHAM STUD CO., Amberley Court, Monmouth, for Trysting Tree, bay colt, bred by C. Howard Taylor, Hampole Priory, Doncaster; s. Mountain Ash 298, d. Confidential 934 by Rosewater 37.
- 107 III. (£5.)—MRS. A. HAYES-SADLER, The Cranhams, Cirencester, for Big Brother, bay colt, bred by the Radnorshire Polo and Riding Pony Co., Ltd., The Farm, Bleddfa, Llanguillo; s. Mootrub 32, d. Bride's Mother 1572 by The Ghost.
- 108 R. N. & H. C.—THE HON. MRS. IVES, Moyns Park, Birdbrook, Essex, for Babetta.
- Class 14.—Polo and Riding Pony Fillies or Geldings, foaled in 1904, not exceeding 14 hands 1½ inches.**<sup>3</sup> [4 entries, 1 absent.]
- 112 I. (£16, & Champion.<sup>2</sup>)—JOHN BARKER, M.P., The Grange, Bishop's Stortford, for Deborah, bay filly; s. Mark For'ard, d. Jew 631 by Pearl Diver.
- 113 II. (£8.)—VICE-ADMIRAL BRIDGEMAN, Copgrove Hall, *vid* Leeds, for Warlock, grey gelding; s. Carnival 172, d. Erin 1386 by The Arrow.
- Class 15.—Polo and Riding Pony Mares, with Foals at foot, not exceeding 14 hands 2 inches.** [7 entries, 2 absent.]
- 116 I. (£15.)—JOHN BARKER, M.P., The Grange, Bishop's Stortford, for Silver Star 1020; bay, foaled 1894 [foal by Rupert 308], bred by G. Hutchings, Claremont, Paignton; s. Knight of the Laund, d. by Acrobat.
- 117 II. (£10.)—JOHN BARKER, M.P., for Wembley 1469, bay, aged [foal by Right For'ard 368], breeder unknown.
- 120 III. (£5.)—O. T. PRICK, Brockenhurst, for Quinine, bay, foaled 1900 [foal by Factotum].
- 118 R. N. & H. C.—THE KEYNSHAM STUD CO., for Grey Wings.

### Cleveland Bays.<sup>4</sup>

**Class 16.—Cleveland Bay Stallions, foaled in 1904 or 1905.**

[3 entries.]

- 124 I. (£15.)—JOHN LETT, Cleveland Stud Farm, Rillington, York, for Special Light, foaled 1905; s. Speciality 1562, d. Mademoiselle 1133 by Lucky Hero 1492.
- 126 II. (£10.)—GEORGE SCOBY, Beadlam Grange, Nawton, York, for Beadlam George 1661, foaled 1905; s. King Fred 1523, d. Beadlam Daisy 1091 by Beadlamite 1368.
- 123 III. (£5.)—FRANK BATEMAN, The Lodge, Shinfield, Reading, for Shinfield Prince, foaled 1905; s. Woodland Pride 1659, d. Lady Fortune 1200.

<sup>1</sup> Champion Gold Medal given by the Polo and Riding Pony Society for the best Stallion or Colt in Classes 11, 12 and 13.

<sup>2</sup> Prizes given by the Polo and Riding Pony Society.

<sup>3</sup> Champion Gold Medal given by the Polo and Riding Pony Society for the best Mare or Filly in Classes 12-15.

<sup>4</sup> The sum of £30 was given by the Cleveland Bay Horse Society towards these Prizes.

lviii *Award of Live Stock Prizes at Lincoln, 1907.*

[Unless otherwise stated, each prize animal named below was "bred by exhibitor."]

**Class 17.—*Cleveland Bay Fillies, foaled in 1904 or 1905.***

[5 entries, none absent.]

- 129 I. (£15.)—H. C. STEPHENS, Cholderton, Salisbury, for *Cholderton Silkstone* 1291, foaled 1905; s. Wellington 1488, d. Cholderton Darling 1106 by Luck's All 189.  
 126 II. (£10.)—GEORGE ELDERS, Toft House Farm, Aislaby, Whitby, for *Aislaby Winner*, foaled 1905; s. Rosedale, d. Aislaby 1169 by Prince George 235.  
 127 III. (£5.)—GEORGE GRANDAGE, Moor Croft, Yeadon, Leeds, for *Woodland Flower*, bay, foaled 1905; s. Woodland Pride 1659, d. Lady Toft 1205 by Prince George 235.

**Class 18.—*Cleveland Bay Mares, with Foals at foot.*** [2 entries.]

- 132 I. (£15.)—J. H. TYERMAN, Pond Farm, Hinderwell, S.O., for *Aislaby Beauty* 1169, foaled 1900 [foal by Rosedale], bred by George Elders, Toft House Farm, Aislaby, Whitby; s. Prince George 235, d. Hetty 949 by Pitch and Toss 1204.  
 131 II (£10.)—FRANK BATEMAN, The Lodge, Shinfield, Reading, for *Woodland Rose* 1320, foaled 1901 [foal by Beadlam Fred], bred by H. C. Stephens, Cholderton, Salisbury; s. Luck's All 189, d. Festive Lass 945 by Marston 1080.

**Coach Horses.<sup>1</sup>**

**Class 19.—*Coaching Stallions, foaled in 1904 or 1905.*** [7 entries, 3 absent.]

- 137 I. (£15.)—GEORGE SCOBY, Beadlam Grange, Newton, York, for stallion, foaled 1905, bred by William Rooke, Rookborough, Kirby Moorside; s. Ingleby Lord, d. Queen of the Valley by Lucky Hero.  
 138 II. (£10.)—F. H. STERICKER, Westgate House, Pickering, for *Haldane* 2456, foaled 1904, bred by the late Thomas Hick, Saltersgate, Lockton, York; s. Lord Chief Justice 1244, d. Jumper 1051 by Lord Ryedale 2344.  
 135 III. (£5.)—GEORGE GRANDAGE, Moorcroft, Yeadon, Leeds, for *Woodland Duke*, foaled 1905, bred by J. Acomb, Stillingleet Hill, York; s. Star of Yorkshire 2359, d. Vanity Fair 1024 by Beckett's Barnaby 2231.

**Class 20.—*Coaching Fillies, foaled in 1904 or 1905.*** [3 entries.]

- 140 I. (£15.)—GEORGE GRANDAGE, Moor Croft, Yeadon, Leeds, for *Woodland May*, foaled 1904, bred by E. & T. Harley, Barlby Bank, Selby; s. Beacon Prince 2237, d. Comus May 941 by Willoughby Prince 1523.  
 142 II. (£10.)—GEORGE SCOBY, Beadlam Grange, Newton, York, for *Beadlam Hylda*, foaled 1904, bred by F. Wilson Horsfall, Potto Grange, Northallerton; s. Marquis 2385, d. Perseverance 840 by Prince George 367.  
 141 III. (£5.)—GEORGE SCOBY, for *Beadlam Beauty*, foaled 1905, bred by F. Wilson Horsfall, Potto Grange, Northallerton; s. Potto Hutton 1603, d. Potto Queen 1219 by King Albert 2378.

**Class 21.—*Coaching Mares, with Foals at foot.*** [3 entries, 1 absent.]

- 144 I. (£15.)—GEORGE GRANDAGE, Moor Croft, Yeadon, Leeds, for *Woodland Briar* 1269, foaled 1902 [foal by Woodland Pride 1659], bred by F. Wilson Horsfall, Potto Grange, Northallerton; s. King of the East 1525, d. Horsfall Progress 948 by Cleveland Park 1052.  
 143 II. (£10.)—WILLIAM BECKETT, Manor House, Copmanthorpe, York, for *Marion* 1127, foaled 1902 [foal by Royalist 2328]; s. Barneby 231, d. Merit 497 by Justice 1242.

**Hackneys.**

**Class 22.—*Hackney Stallions, foaled in 1906.*** [6 entries, 1 absent.]

- 147 I. (£15.)—SIR WALTER GILBEY, BT., Elsenham Hall, Essex, for *Flash Cadet*, bay; s. His Majesty 2513, d. Lady Cadet 8024 by Cadet 1251.  
 148 II. (£10.)—SIR LEES KNOWLES, BT., Westwood, Pendlebury, Manchester, for *Salford Viscount*, chestnut; s. Dainty Duke 7417, d. Park House Duchesse 5966 by Prince Alfred 1325.  
 151 III. (£5.)—H. V. SHERINGHAM, South Creake, Fakenham, for *Creake Connaught*, chestnut; s. Copper King 7764, d. Creake Sylvia 15017 by Challenger 3013.  
 149 E. N. & H. C.—HENRY MOORE, Burn Butta, Cranswick, Hull.

**Class 23.—*Hackney Stallions, foaled in 1905.*** [9 entries, 1 absent.]

- 56 I. (£15.)—THOMAS & ARTHUR HALL, Copmanthorpe Grange, York, for *King of the West*, chestnut; s. Garton Duke of Connaught 3009, d. Queen of the Dales 4617 by Eddlethorpe Fireaway 1768.  
 56 II. (£10.)—R. P. EVANS, Woodhatch House, Reigate, for *Kingsway* 9781, chestnut; s. Copper King 7764, d. Queen Mab 8395 by Leighton East Riding 1475.  
 57 III. (£5.)—MRS. E. FLITCHER, The Grange Hackney Stud, Angram, York, for *Angram St. Thomas* 9588, chestnut, bred by the late Benjamin Wilson, Kirbysmespton, Pickering; s. St. Thomas 7261, d. Lady Stanley 10190 by Remus 5900.  
 150 E. N. & H. C.—JOHN LETT, Rillington, York, for *Rillington Excelsior*.

<sup>1</sup> The sum of £30 was given by the Yorkshire Coach Horse Society towards these Prizes.

[Unless otherwise stated, each prize animal named below was "bred by exhibitor."]

**Class 24.—Hackney Stallions, foaled in 1904.** [6 entries, 1 absent.]

- 164 I. (£15, & Champion.<sup>1</sup>)—ARTHUR HALL, Copmanthorpe Grange, York, for Copmanthorpe Performer 9870, chestnut, bred by George Hall, Bishop Wilton, Wilberfoss, York; s. Garton Duke of Connaught 3009, d. Copmanthorpe Lily 18124 by Langton.  
 162 II. (£10, & E. N. for Champion.<sup>1</sup>)—R. P. EVANS, Woodhatch House, Reigate, for Gartonius 9236, chestnut; s. Garton Duke of Connaught 3009, d. Julia 11929 by Dagenham 4214.  
 163 III. (£5.)—MRS. E. FLETCHER, The Grange Hackney Stud, Angram, York, for Angram Performer 9093, chestnut; s. Ganymede 2076, d. Angram Garton Duchess 13228 by Garton Duke of Connaught 3009.  
 161 R. N. & H. C.—COCKAYNE BROS., Sheffield, for Paddock Grand Slam.

**Class 25.—Hackney Fillies, foaled in 1906.** [5 entries, 1 absent.]

- 170 I. (£15.)—SIR WALTER GILBEY, BT., Eelsenham Hall, Essex, for Flash Clara, chestnut; s. Royal Danegelt 5785, d. Bonnie Clara 6419 by Connaught 1453.  
 168 II. (£10.)—STEPHEN CLIFF, Crayke Manor, Easingwold, for chestnut; s. Crayke Noble 8904, d. Crayke Aunice 15012 by His Majesty 2513.  
 171 III. (£5.)—J. P. PENTLELOW, Tollington House, Somersham, for Lady Forest, bay; s. Forest Star 7446, d. Hunts Lady 15168 by Hunts Cadet 6785.

**Class 26.—Hackney Fillies, foaled in 1905.** [7 entries, 4 absent.]

- 173 I. (£15, & E. N. for Champion.<sup>2</sup>)—SIR WALTER GILBEY, BT., Eelsenham Hall, Essex, for Lively Beeswing 18370, chestnut; s. Royal Danegelt 5785, d. Lady Cadet 8024 by Cadet 1251.  
 172 II. (£10.)—MRS. E. FLETCHER, The Grange Hackney Stud, Angram, York, for Angram Queen 17965, chestnut; s. Ganymede 2076, d. Lady Connaught 11981 by Connaught 1453.  
 175 III. (£5.)—J. P. PENTLELOW, Tollington House, Somersham, for Lady Tollington 18248, chestnut; s. Mathias 6473, d. Hunts Lady 15168 by Hunts Cadet 6785.

**Class 27.—Hackney Fillies, foaled in 1904.** [7 entries, 3 absent.]

- 162 I. (£15.)—W. H. CLARK, White Hall, Winestead, Hull, for Skeffling Lily 17737, bay; s. Skeffling Fireway 8650, d. Winsett's Lily 9656 by Saxon 2674.  
 186 II. (£10.)—W. J. TENNANT, Carleton, Pontefract, for Special Beauty 18608, dark chestnut; s. Royal Danegelt 5785, d. Marois Queen 15281 by Connaught 1453.  
 183 III. (£5.)—R. P. EVANS, Woodhatch House, Reigate, for Cristolia 17233, bay; s. Polonius 4931, d. Woodhatch Cristobelle 16372 by Ganymede 2076.  
 181 R. N. & H. C.—JAMES G. BROWNE, Ringley House, Romford, for Golden Top.

**Class 28.—Hackney Mares, with Foals at foot, over 14 hands and not exceeding 15 hands 2 inches.** [7 entries, 2 absent.]

- 187 I. (£15.)—W. H. CLARK, White Hall, Winestead, Hull, for Winsetts Lily 9656, bay, foaled 1894 [foal by Skeffling Fireway 8650], bred by John Biglin, Winsetts House, Skeffling, Patrington; s. Saxon 2674, d. Jersey Lily 5443 by Lord Derby 2nd 417.  
 188 II. (£10, & E. N. for Special.<sup>3</sup>)—COCKAYNE BROS., Sheffield Lane Paddocks, Sheffield, for Paddock Queen 14651, chestnut, foaled 1899 [foal by Paddock Polonia 7206]; s. His Majesty 2513, d. Royal Beauty 2433 by Lord Derby 2nd 417.  
 190 III. (£5.)—H. V. SHERINGHAM, South Creak, Fakenham, for Creake Sylvia 15017, chestnut, foaled 1801 [foal by Copper King 7764]; s. Challenger 3013, d. Maidie 11241 by Silvio 4983.  
 186 R. N. & H. C.—S. B. CARNLEY, Norbury House Stud, Alford, for Norbury Cantatrice.

**Class 29.—Hackney Mares, with Foals at foot, over 15 hands 2 inches.<sup>4</sup>**

[5 entries, 1 absent.]

- 164 I. (£15, & Champion.<sup>2</sup>)—R. P. EVANS, Woodhatch House, Reigate, for District Maid 15039, chestnut, foaled 1901 [foal by Evanthus 8463]; s. Roador 4964, d. Busy Sunflower 1950 by Rob Roy 1339.  
 196 II. (£10.)—MISS DORA SCHINTZ, Childwall Hall, Liverpool, for Knowle Belinda 14470, chestnut, foaled 1900 [foal by Mathias 6473], bred by the late E. Edmondson, Springfield Hall, Knowle; s. His Majesty 2513, d. Garton Birthday 9970 by Garton Duke of Connaught 3009.  
 195 III. (£5, & Special.<sup>3</sup>)—SIR WALTER GILBEY, BT., Eelsenham Hall, Essex, for Gallant Girl 15083, chestnut, foaled 1901 [foal by Hedon Sportsman 8511]; s. Revival 7236, d. Titania 7502 by Gallant Sportsman 2075.  
 197 R. N. & H. C.—ROBERT SURFLEET, Beckingham, Gainsborough, for Miss Helmsley.

<sup>1</sup> Champion Gold Medal, value £10, given by the Hackney Horse Society for the best Stallion in Classes 22-24.

<sup>2</sup> Champion Gold Medal, value £10, given by the Hackney Horse Society for the best Mare or Filly in Classes 25-29.

<sup>3</sup> Special Prize of £10 given by the Lincolnshire Agricultural Society, for Members of that Society only, for the best Brood Mare in Classes 28 and 29.

<sup>4</sup> Prizes given by the Hackney Horse Society.

ix *Award of Live Stock Prizes at Lincoln, 1907.*

[Unless otherwise stated, each prize animal named below was "bred by exhibitor."]

**Class 30.—Hackney Colt Foals, the produce of mares exhibited in  
Classes 28 or 29.<sup>1</sup> [5 entries, 2 absent.]**

- 199 I. (£10).—W. H. CLARK, White Hall, Winestead, Hull, for dark bay; s. Skeffing Fire-away 8650, d. Winsetts Lily 8656 by Saxon 2874. [Exhibited with No. 187 in Class 28.]  
201 II. (£8).—MISS DORA SCHINTZ, Childwall Hall, Liverpool, for chestnut; s. Mathias 6473, d. Knowle Belinda 14470 by His Majesty 2513. [Exhibited with No. 196 in Class 29.]  
200 III. (£4).—J. P. PRYNELOW, Tollington House, Somersham, for black; s. Gay Lothair 9558, d. Hunts Lady 15168 by Hunts Cadet 8785. [Exhibited with No. 189 in Class 28.]

**Class 31.—Hackney Filly Foals, the produce of Mares exhibited in  
Classes 28 or 29.<sup>1</sup> [6 entries, none absent.]**

- 206 I. (£10).—ROBERT SURFLEET, Beckingham, Gainsborough, for chestnut; s. Beckingham Squire 8079, d. Miss Helmsley 12953 by Danebury 4724. [Exhibited with No. 197 in Class 29.]  
205 II. (£6).—R. P. EVANS, Woodhatch House, Reigate, for Woodhatch Maid, chestnut; s. Eranthus 8463, d. District Maid 15039 by Rosador 4964. [Exhibited with No. 194 in Class 29.]  
206 III. (£4).—SIR WALTER GILBEY, BT., Elsenham Hall, Essex, for chestnut; s. Hedon Sportsman 8511, d. Gallant Girl 15093 by Revival 7236. [Exhibited with No. 195 in Class 29.]  
207 E. N. & H. C.—H. V. SHERINGHAM, South Creake, Fakenham.

**Hackney Ponies.**

**Class 32.—Hackney Pony Stallions, foaled in or before 1904, not  
exceeding 14 hands. [4 entries.]**

- 208 I. (£15).—CALEB JONES, 62 Wicker, Sheffield, for Warburton Aneroid 9487, dark bay, foaled 1902, bred by Sir Gilbert Greenall, Bt., Walton Hall, Warrington; s. Sir Horace 5402, d. Tissington Lady Ann 14013 by Sir Gibbie 1612.  
210 II. (£10).—J. ERNEST KERR, Harviestoun Castle, Dollar, for Johnnie Cope, brown, foaled 1903, bred by Sir Gilbert Greenall, Bt., Walton Hall, Warrington; s. Sir Horace 5402, d. Tissington Lady Ann 14013 by Sir Gibbie 1612.  
212 III. (£5).—C. H. RAVENHILL STOCK, Fishwick Hall, Preston, for Son o'Horace 8653, bay, foaled 1902; s. Sir Horace 5402, d. Witch o'Denmark 16356 by Sir Gibbie 1612.  
211 E. N. & H. C.—O. T. PRICE, Brockenhurst, for Lyndhurst Phosphorus.

**Class 33.—Hackney Pony Colts, Geldings, or Fillies, foaled in 1905, not  
exceeding 13 hands 2 inches.<sup>1</sup> [4 entries, 1 absent.]**

- 216 I. (£10).—W. WAINWRIGHT & SONS, Talke Pony Stud, Stoke-on-Trent, for Talke Wonder, bay colt; s. Carleton Wonder 7398, d. Jenny Snorer 8009 by Little Wonder 2nd 1610.  
213 II. (£8).—WILLIAM FOSTER, Mel-Valley, Moseley, Worcs, for Mel-Valley Snorter, bay colt, bred by A. Stacey, Appleby; s. Snorter, d. Mel-Valley's Birthday 14570 by Sir Horace 5402.  
214 E. N. & H. C.—GILBERT ROBINSON, for Brixworth Sharp Speculator.

**Class 34.—Hackney Pony Fillies or Geldings, foaled in 1904, not  
exceeding 13 hands 3 inches.<sup>1</sup> [3 entries.]**

- 218 I. (£10).—WILLIAM FOSTER, Mel-Valley, Moseley, Worcs, for Mel-Valley's Wonder, bay gelding, bred by J. Huxley, Mulsford Farm, Malpas; s. Whitegate Swell.  
219 II. (£8).—O. T. PRICE, Brockenhurst, for Lyndhurst Firegirl 17535, bay filly; s. Fireboy 7440, d. Peggy Sure Four 13014 by Dane Royal 5575.  
217 III. (£5).—WILLIAM FOSTER, for Mel-Valley's Prince of Holland, bay gelding, bred by Sir Gilbert Greenhall, Bt., Walton Hall, Warrington; s. Sir Horace 5402, d. Ailsa 8522 by Goldfinder 6th 1791.

**Class 35.—Hackney Pony Mares, with Foals at foot, not exceeding 14 hands.  
[4 entries, 2 absent.]**

- 220 I. (£15).—GEORGE PIMLOTT, Stamford Stud, Altrincham, for Lady Wellford 15965, chestnut, foaled 1897 [foal by His Majesty 2513], bred by George Burton, Thorpe Villoughby, Selby; s. Polonius 4931, d. Lady Rufus 5640 by Rufus 1943.  
221 II. (£10).—O. T. PRICE, Brockenhurst, for Mivvy Star 8269, brown, foaled 1894 [foal by Lyndhurst Phosphorus 8942], bred by J. McMullen, Newpark, Dimbreck; s. Sir John 8290, d. Merry Polly 8250 by Merry Sunshine 1523.

<sup>1</sup> Prizes given by the Hackney Horse Society.

## Shetland Ponies ; Riding and Driving Classes. lxi

[Unless otherwise stated, each prize animal named below was "bred by exhibitor."]

### Shetland Ponies.

**Class 36.**—*Shetland Pony Stallions, foaled in or before 1904, not exceeding 10½ hands.* [2 entries.]

- 234 I. (£10. & Champion.<sup>1</sup>)—THE LADIES E. & D. HOPE, Great Hollenden, Underriver, Sevenoaks, for Thorsau, black, foaled 1903; s. Odin 32, d. Thora 212 by Odin 52.  
 236 II. (£8.)—R. W. R. MACKENZIE, EarlsHall, Leuchars, for Marquis of EarlsHall 322, black, foaled 1901; s. Rattler 210, d. Meta 1368 by Thor 83.

**Class 37.**—*Shetland Pony Mares, foaled in or before 1904, not exceeding 10½ hands.* [7 entries, 1 absent.]

- 230 I. (£10. & R. N. for Champion.<sup>1</sup>)—R. W. R. MACKENZIE, EarlsHall, Leuchars, for Strawberry 1635, dark brown, foaled 1898, bred by the Marquis of Londonderry, Bressay, Shetland; s. Odin 32, d. Sweetie 876 by Lord of the Isles 28.  
 238 II. (£8.)—THE LADIES E. & D. HOPE, Great Hollenden, Underriver, Sevenoaks, for Corona, black, foaled 1902; s. Odin 32, d. Hoplemuronia 130.  
 239 R. N. & H. C.—THE LADIES E. & D. HOPE, for Freesia.

### Riding and Driving Classes.<sup>2</sup>

**Class 38.**—*Hunter Mares or Geldings, foaled in 1903, up to from 12 to 14 stone.* [11 entries, 1 absent.]

- 237 I. (£15.)—EDWARD HODGSON, The Hollows, Bridlington, for Sportsman, grey gelding, bred by F. Grainger, Boston Spa; s. Wales, d. Lady Greylock.  
 241 II. (£10. & Special.<sup>3</sup>)—J. H. STOKES, Nether House, Great Bowden, Market Harborough, for Black Pearl, black mare, bred by T. B. Newton, Gilling Grange, Richmond, Yorks; s. Knight of Ruby.  
 242 III. (£5.)—J. H. STOKES, for Dirk Moor, bay gelding, bred by H. Mason, Kynnersley Manor, Wellington, Salop; s. Dirk Hatteraik, d. Ladylike 2930 by Bookworm.  
 238 R. N. & H. C.—GEOFF. KENYON, Walshaw Hall, Bury, for Destruction.

**Class 39.**—*Hunter Mares or Geldings, foaled in 1903, up to more than 14 stone.* [7 entries, 1 absent.]

- 244 I. (£15.)—JOHN DRAGE, Chapel Brampton, Northampton, for brown gelding, breeder unknown.  
 249 II. (£10.)—J. H. STOKES, Nether House, Great Bowden, Market Harborough, for Masterpiece, brown gelding, bred by T. Aynton, Damas Gill, Quernmore, Lancaster; s. Colonial, d. Damas Queen by Carthusian.  
 248 III. (£5.)—J. H. STOKES, for Lord Crafty, chestnut gelding, bred by P. Foley, Fermoy, Co. Cork; s. Crafty, d. by Ben.  
 245 R. N. & H. C.—WILLIAM GALE, Waltham, Melton Mowbray, for Cornkist.

**Class 40.**—*Hunter Mares or Geldings, Novices, foaled in or before 1902, up to from 12 to 14 stone.* [13 entries, 3 absent.]

- 252 I. (£15.)—JOHN DRAGE, Chapel Brampton, Northampton, for chestnut gelding foaled 1902, breeder unknown.  
 253 II. (£10.)—GORDON B. FOSTER, The Hall, Thorne, near Doncaster, for Scarlet Rambler, chestnut gelding, foaled 1902, bred by Luke Irwin, United Service Club, Dublin; s. Bona Rosa, d. Miss Scarlet by Will Scarlet.  
 257 III. (£5.)—CAPT. R. F. GOOCH, Banbury, for Warwick, bay gelding, foaled 1902.  
 261 R. N. & H. C.—J. H. STOKES, Great Bowden, Market Harborough, for Goldmint 2nd.

**Class 41.**—*Hunter Mares or Geldings, Novices, foaled in or before 1902, up to more than 14 stone.* [9 entries, 2 absent.]

- 265 I. (£15.)—JOHN DRAGE, Chapel Brampton, Northampton, for Mercedes, bay gelding, foaled 1901.  
 272 II. (£10.)—J. H. STOKES, Nether House, Great Bowden, Market Harborough, for Orion, brown gelding, foaled 1901, breeder unknown.  
 266 III. (£5.)—WILLIAM GALE, Waltham, Melton Mowbray, for Dan Leno, chestnut gelding, foaled 1902, bred by James Carlyle, Pingle, Canonbie; s. Dan Dancer, d. by Redcapsby.  
 270 R. N. & H. C.—GILBERT ROBINSON, Brixworth Hall, Northampton, for Paleface.

<sup>1</sup> Silver Medal given by the Shetland Pony Stud Book Society for the best Shetland Pony in Classes 36 and 37.

<sup>2</sup> Prizes given by the Lincoln Local Committee.

<sup>3</sup> Special Prize of £10 given by the Lincolnshire Agricultural Society, for Members of that Society only, for the best Hunter Mare in Classes 38-41.

## lxiii *Award of Live Stock Prizes at Lincoln, 1907.*

[Unless otherwise stated, each prize animal named below was "bred by exhibitor."]

**Class 42.—*Hunter Mares or Geldings, foaled in or before 1903, up to from 12 stone to 13 stone 7 lb.*** [9 entries, 3 absent.]

261 I. (£20).—J. H. STOKES, Nether House, Great Bowden, Market Harborough, for *Goldmint 2nd*, chestnut gelding, foaled 1901.

273 II. (£10).—JOHN DRAGE, Chapel Brampton, Northampton, for *All Geld*, chestnut gelding, foaled 1901.

275 III. (£5).—HENRY KIDD, Lowood, Melrose, for *Oello*, chestnut gelding, foaled 1902, breeder unknown.

255 R. N. & H. C.—WILLIAM GALE, Waltham, Melton Mowbray, for *Michael*.

**Class 43.—*Hunter Mares or Geldings, foaled in or before 1903, up to more than 13 stone 7 lb. and not more than 15 stone.*** [12 entries, 2 absent.]

261 I. (£20, & Special.<sup>1</sup>)—J. H. STOKES, Nether House, Great Bowden, Market Harborough, for *Whisky*, bay gelding, foaled 1899, bred by P. Gilsman, Trim, Co. Meath; s. *Sir Patrick*, d. *by Play Actor*.

277 II. (£10).—JOHN DRAGE, Chapel Brampton, Northampton, for *Chatterbox 2nd*, chestnut gelding, foaled 1902.

252 III. (£5).—JOHN DRAGE, for chestnut gelding, foaled 1902, breeder unknown.

260 R. N. & H. C.—HENRY KIDD, Lowood, Melrose, for *Derische*.

**Class 44.—*Hunter Mares or Geldings, foaled in or before 1903, up to more than 15 stone.*** [9 entries, 2 absent.]

283 I. (£20, & R. N. for Special.<sup>1</sup>)—J. H. STOKES, Nether House, Great Bowden, Market Harborough, for *Ardon*, brown gelding, foaled 1901, bred by Mr. Waltree, Navan; s. *Amos*, d. *Chloe by Revolver*.

284 II. (£10).—J. H. STOKES, for *Biscuit*, bay gelding, foaled 1902, breeder unknown.

285 III. (£5).—JOHN DRAGE, for *Mercedes*. (See Class 41.)

266 R. N. & H. C.—WILLIAM GALE, for *Dan Leno*. (See Class 41.)

### Polo and Riding Ponies.

**Class 45.—*Polo and Riding Pony Mares or Geldings, foaled in 1903 or 1903, not exceeding 14 hands 2 inches, or with Hurlingham Certificate.***

[8 entries, none absent.]

292 I. (£15).—O. T. PRICE, Brockenhurst, for *Sequence*, grey gelding, foaled 1902.

286 II. (£10).—WILLIAM GALE, Waltham, Melton Mowbray, for *The Fad*, bay gelding, foaled 1902.

285 III. (£5).—JOHN BARKER, M.P., The Grange, Bishop's Stortford, for *Dolly*, bay mare, foaled 1902, bred by M. Hincks, Broadwell, Stockton, Rugby; s. *Naughty Boy*, d. *Royal Sarah by Royal Fern*.

269 R. N. & H. C.—THE KEYNHAM STUD CO., for *Modest Maiden*.

### Harness Horses and Ponies.<sup>2</sup>

**Class 46.—*Harness Mares or Geldings, Novices, not exceeding 14 hands.***

[8 entries, 2 absent.]

293 I. (£10).—WILLIAM FOSTER, Mel-Valley, Moseley, Worcestershire, for *Mel-Valley's Veronique*, chestnut mare, foaled 1902, breeder unknown.

294 II. (£6).—HOWARD FRANK, Rusthall, Wimbledon Common, for *Tissington Cock Robin*, dark brown gelding, foaled 1903, bred by Sir Gilbert Greenall, Bt., Walton Hall, Warrington; s. *Contest 1746*, d. *Tissington Snorer 14020 by Sir Horace 5402*.

298 III. (£4).—J. RAYNOB, Abbeydale, Mansfield, for *Gay Girl*, brown mare, foaled 1900, bred by Mr. Harrison, Attlebridge, Brandon Parva; s. *Leeds Monarch 463*.

297 R. N. & H. C.—A. D. OATES, Ryburn Stud, Halifax, for *Ryburn Bantam*.

**Class 47.—*Harness Mares or Geldings, Novices, over 14 hands and not exceeding 15 hands.*** [5 entries, 1 absent.]

292 I. (£10).—PAUL HOFFMANN, 4 Cardigan Mansions, Richmond Hill, Surrey, for *The Gentleman*, bay gelding, foaled 1901, bred by Sir Gilbert Greenall, Bt., Walton Hall, Warrington; s. *Sir Horace 5402*.

301 II. (£6).—COOKAYNE BROS., Sheffield Lane Paddocks, Sheffield, for *Paddock Lucy*, bay mare, foaled 1901; s. *Candidate*, d. *Lucy Bother 'em 3015*.

303 III. (£4).—MRS. FRED HOLMES, 6 N, Bickenhall Mansions, Gloucester Place, London, W., for *Dainty Kate*, chestnut mare, foaled 1903; s. *Grandmaster 2nd 5230*, d. *Bride 7490 by Gunymede 2076*.

305 R. N. & H. C.—MRS. J. H. TATE, Freeman Street, Grimsby, for *Lenwods Swell*.

<sup>1</sup> Special Prize of £10 given by the Lincolnshire Agricultural Society, for Members of that Society only, for the best Hunter Mare in Classes 38-44.

<sup>2</sup> Prizes given by the Lincoln Local Committee.

[Unless otherwise stated, each prize animal named below was "bred by exhibitor."]

**Class 48.—Harness Mares or Geldings, Novices, over 15 hands and not exceeding 15 hands 2 inches.** [5 entries, 2 absent.]

- 300 I. (♂10).—ROBERT SURFLEET, Beckingham, Gainsborough, for *Carmania*, chestnut gelding, foaled 1902, bred by G. Revill, Blyton, Carr; s. Cave Performer, d. by Fire-away.  
 306 II. (♂6).—COCKAYNE BROS., Sheffield Lane Paddocks, Sheffield, for *Paddock Handyman*, chestnut gelding, foaled 1903; s. Paddock Polonius 7208, d. Paddock Bell.  
 307 III. (♂4).—J. W. COOK, The Grange, Kirton Lindsey, for *Kirton Squire*, chestnut gelding, foaled 1903; s. Incandescent, d. Lovechase.

**Class 49.—Harness Mares or Geldings, Novices, over 15 hands 2 inches.** [9 entries, 2 absent.]

- 316 I. (♂10, & R. N. for Champion.<sup>1</sup>)—MISS DORA SCHINTZ, Childwall Hall, Liverpool, for *Morocco*, dark chestnut gelding, foaled 1900, bred by G. N. Stephenson, Manor House, Goodmanham; s. Revival 7263, d. May Flower 765 by Lord Derby 2nd 417.  
 315 II. (♂6).—MISS ELLA S. ROSS, Beechfield, Sale, for *Grand Vizier*, black gelding, foaled 1902, bred by H. Whittick, Newland, Hull; s. Gentleman John 3624, d. Fairy Queen 6643 by Curfew 1755.  
 313 III. (♂4).—S. LEAR, Souttergate, Hedon, Hull, for *Coltman Squire*, bay gelding, foaled 1903, bred by Mr. Thirsk, Newbald; s. Pomfret Performer.  
 314 R. N. & H. C.—A. D. OATES, Ryburn Stud, Halifax, for *Ryburn Silver King*.

**Class 50.—Harness Mares or Geldings, not exceeding 13 hands 2 inches.** [6 entries, none absent.]

- 218 I. (♂10).—WILLIAM FOSTER, for *Mel-Valley's Wonder*. (See Class 34.)  
 300 II. (♂6).—JOHN H. TATE, Freeman Street, Grimsby, for *Monafy* 17593, brown mare, foaled 1903, bred by W. H. Hanson, Lindum House, Gainsboro; s. Fireboy 7440, d. Mona 9349.  
 295 III. (♂4).—CALEB JONES, 62 Wicker, Sheffield, for *Tissington Kiddy* 16287, bay mare, foaled 1902, bred by Sir Gilbert Greenall, Bt., Walton Hall, Warrington; s. Sir Horace 5402, d. Lady Kate 4117.  
 297 R. N. & H. C.—A. D. OATES, Ryburn Stud, Halifax, for *Ryburn Bantam*.

**Class 51.—Harness Mares or Geldings, over 13 hands 2 inches and not exceeding 14 hands.** [3 entries.]

- 320 I. (♂10).—HOWARD FRANK, Rusthall, Wimbledon Common, for *Tissington Kit Cat*, dark brown mare, foaled 1901, bred by Sir Gilbert Greenall, Bt., Walton Hall, Warrington; s. Sir Horace 5402, d. Lady Kate 4117 by Sir George 778.  
 293 II. (♂6).—WILLIAM FOSTER, for *Mel-Valley's Veronique*. (See Class 46.)  
 294 III. (♂4).—HOWARD FRANK, for *Tissington Cock Robin*. (See Class 46.)

**Class 52.—Harness Mares or Geldings, over 14 hands and not exceeding 15 hands.** [9 entries, 3 absent.]

- 326 I. (♂10).—HENRY RODMELL, The Hollies, Holderness Road, Hull, for *Prince Fortunatus* 8976, chestnut gelding, foaled 1903, bred by T. Mitchell, Eccleshill, Bradford; s. Grand Master 2nd 5230, d. Inholmes Princess 8997.  
 322 II. (♂6).—PAUL HOFFMANN, 4 Cardigan Mansions, Richmond Hill, Surrey, for *The Gem* 15210, bay mare, foaled 1901, bred by Robert Forrest, Knockinlaw, Kilmarnock; s. Mathias 6473, d. Lady Mary 207 by Lord Derby 2nd 417.  
 323 III. (♂4).—JOHN KERR, Loudwater, Rickmansworth, for *Loudwater Flourish*, bay gelding.  
 303 R. N. & H. C.—MRS. FRED HOLMES, 6 N, Bickenhall Mansions, W., for *Dainty Kate*.

**Class 53.—Harness Mares or Geldings, over 15 hands and not exceeding 15 hands 2 inches.** [10 entries, 3 absent.]

- 322 I. (♂10, & Champion.<sup>1</sup>)—S. R. TENNANT, Great Kendale, Driffeld, for *Authority*, bay gelding, foaled 1900; s. Ganymede 2076, d. Family Pride 3728 by Lord Derby 2nd.  
 329 II. (♂6).—PAUL HOFFMANN, 4 Cardigan Mansions, Richmond Hill, Surrey, for *Riot*, dark chestnut gelding, foaled 1902, bred by W. Burdett-Coutta, M.P., Brookfield Stud, Highgate; s. Polonius 4931, d. Emeute by Candidate 920.  
 306 III. (♂4).—COCKAYNE BROS., for *Paddock Handyman*. (See Class 48.)  
 330 R. N. & H. C.—J. RAYNOR, Abbeydale, Mansfield, for *Gay Boy*.

**Class 54.—Harness Mares or Geldings, over 15 hands 2 inches.** [7 entries, none absent.]

- 316 I. (♂10, & R. N. for Champion.<sup>1</sup>)—MISS DORA SCHINTZ, for *Morocco*. (See Class 49.)  
 335 II. (♂6).—JOHN KERR, Loudwater, Rickmansworth, for *Loudwater Robin Hood*, bay gelding.  
 315 III. (♂4).—MISS ELLA S. ROSS, for *Grand Vizier*. (See Class 49.)  
 312 R. N. & H. C.—COCKAYNE BROS., Sheffield, for *Paddock Performer*.

<sup>1</sup> Gold Medal, value 25, given by the Hackney Horse Society for the best Mare or Gelding in Classes 48-54, the produce of a registered Hackney Stallion.

## lxiv Award of Live Stock Prizes at Lincoln, 1907.

[Unless otherwise stated, each prize animal named below was "bred by exhibitor."]

**Class 55.**—*Pairs of Harness Mares or Geldings, not exceeding 15 hands 2 inches, driven in Double Harness.* [5 entries, 2 absent.]

339 I. (£10.)—JOHN KERR, Loudwater, Rickmansworth, for Loudwater Flourish, bay gelding; and Loudwater Fashion, bay gelding.

337 II. (£6.)—COCKAYNE BROS., for Paddock Handyman (see Class 48); and Paddock Lillian, chestnut mare, foaled 1903, bred by G. H. Barber, Woodhouse; s. Paddock Polonius 7208, d. Phornenia.

**Class 56.**—*Pairs of Harness Mares or Geldings, exceeding 15 hands 2 inches, driven in Double Harness.* [3 entries.]

343 I. (£10.)—MISS ELLA S. ROSS, for Grand Vizier (see Class 49); and Rowton Blackthorn 5778, black gelding, foaled 1894, bred by J. W. Macfie, Rowton Hall, Chester; s. Grand Fashion 2nd 3024, d. Blackie 1449 by King Cole 2130.

341 II. (£6.)—JOHN KERR, Loudwater, Rickmansworth, for Loudwater Robin Hood, bay gelding; and Loudwater Little John, bay gelding.

342 III. (£4.)—A. D. OATES, Ryburn Stud, Halifax, for Ryburn Silver King, dark chestnut gelding, foaled 1903, bred by H. Mackusick, Lyttel Hall, Nutfield; s. Copper King 7764, d. Fru Fru; and Ryburn Sensation 17697, dark chestnut mare, foaled 1902, bred by H. Fawcett, Farey Foss, York; s. Lord Bolton 9316, d. Janet by Ganymede 2076.

**Class 57.**—*Pairs of Harness Mares or Geldings, not exceeding 15 hands, driven Tandem.* [4 entries, 1 absent.]

345 I. (£10.)—PAUL HOFFMANN, for The Gem (see Class 52); and The Gentleman (see Class 47).

**Class 58.**—*Pairs of Harness Mares or Geldings, exceeding 15 hands, driven Tandem.* [4 entries, 1 absent.]

343 I. (£10.)—MISS ELLA S. ROSS, Beechfield, Sale, for Grand Vizier (see Class 49); and Rowton Blackthorn (see Class 56).

341 II. (£6.)—JOHN KERR, Loudwater, Rickmansworth, for Loudwater Robin Hood, bay gelding; and Loudwater Little John, bay gelding.

338 III. (£4.)—PAUL HOFFMANN, for Riot (see Class 53); and Rapid, dark chestnut mare, foaled 1901, bred by A. Craggy, North Newbald, Brough; s. St. Thomas 7261, d. Sleigh Bells 13069 by Garton Duke of Connaught 3009.

## JUMPING AND PACE AND ACTION COMPETITIONS.<sup>1</sup>

**Class A.**—*Mares or Geldings, not exceeding 15 hands 2 inches.* [13 entries.]

- 1 I. (£20.)—F. VOLLER GRANGE, Oak House, Farndon, for Rufus, chestnut gelding.
- 7 II. (£15.)—T. & H. WARD, Pinchinthorpe, Great Ayton, for Fisherman, bay gelding.
- 13 III. (£10.)—THOMAS GLENCROSS, Garth House, Frome, for Blisk Bonny, bay mare.
- 2 E. N. & H. C.—B. M. SIMS, Burrowfield Lodge, Borrowash, for Grey Light.

**Class B.**—*Unsuccessful Competitors in Class A.* [10 entries.]

- 2 I. (£10.)—B. M. SIMS, Burrowfield Lodge, Borrowash, for Grey Light, grey mare.
- 3 II. (£5.)—JOHN COLEMAN, The Farm, Epsom, for White Rose, grey mare.
- 8 III. (£3.)—W. W. GRUNDY, 30 Broad St., Worcester, for Stratford Lass, black mare.

**Class C.**—*Mares or Geldings, over 15 hands 2 inches.* [12 entries.]

- 7 I. (£20.)—GEORGE LEDSON, Manor House, Bromborough, for Pioneer, bay gelding.
- 2 II. (£15.)—F. W. FOSTER, Culland, Brailsford, Derby, for Paddy, bay gelding.
- 9 III. (£10.)—JOHN COLEMAN, The Farm, Epsom, for Kangaroo, bay mare.

**Class D.**—*Unsuccessful Competitors in Class C.* [9 entries.]

- 4 I. (£10.)—JOHN COLEMAN, The Farm, Epsom, for Tip-top, bay gelding.
- 1 II. (£5.)—WELLBURN BROS., Huddleston Hall, S. Milford, for General, black gelding.
- 1 III. (£3.)—W. W. GRUNDY, 30 Broad St., Worcester, for Triton, chestnut gelding.

**Class E.**—*Champion Class. Mares or Geldings, any height.* [16 entries.]

- 1 I. (£20.)—W. W. GRUNDY, 30 Broad St., Worcester, for Stratford Lass, black mare.
- 1 II. (£15.)—THOMAS GLENCROSS, Garth House, Frome, for Blisk Bonny, bay mare.
- 1 III. (£10.)—F. W. FOSTER, Culland, Brailsford, Derby, for Paddy, bay gelding.
- 1 IV. (£8.)—WALTER B. GRUNDY, for Triton, chestnut gelding.
- 1 V. (£6.)—JOHN COLEMAN, The Farm, Epsom, for Tip-top, bay gelding.
- 1 VI. (£4.)—WHITTINGHAM BROS., Burton-on-Trent, for Snowdrop, grey mare.

<sup>1</sup> Prizes given by the Lincoln Local Committee.



[Unless otherwise stated, each prize animal named below was "bred by exhibitor."]

### High Jumping.

Class H. [14 entries.]

- 11 I. (£50).—THOMAS GLENCROSS, Garth House, Frome, for *Blink Bonny*, bay mare.  
 2 II. (£20).—F. VOLLEGE GRANGE, Oak House, Farndon, for *Eufus*, chestnut gelding.  
 5 III. (£10).—JOHN COLEMAN, The Farm, Epsom, for *White Rose*, grey mare.

Class I. [11 entries.]

- 30 I. (£30).—C. APPLEYARD, Highfield, Bubwith, Selby, for *Playmate*, bay gelding.  
 29 II. (£20).—WHITTINGHAM BROS., Burton-on-Trent, for *Snowdrop*, grey mare.  
 31 III. (£10).—MRS. GERTRUDE H. DUDLEY SMITH, 9 Richmond Terrace, Hull, for *Dainty Lass*, roan mare.

### Pace and Action.

Class F.—*Single Harness Horses, not exceeding 15 hands.*

[4 entries, 1 absent.]

- 17 I. (£20).—WALTER WINANS, Surrenden Park, Pluckley, for *Topsy*, bay mare.  
 14 II. (£10).—D. S. CARR, Wembley, for *Clyde Vale Queen*, bay mare.  
 15 III. (£5).—CONRAD TYSON, Cadeby Hall, North Thoresby, S.O., for bay gelding.

Class G.—*Single Harness Horses, exceeding 15 hands.* [4 entries.]

- 21 I. (£20).—WALTER WINANS, Surrenden Park, Pluckley, for *Kent*, bay gelding.  
 19 II. (£10).—J. RAYNOR, Abbeydale, Mansfield, for *Gay Boy*, piebald gelding.  
 20 III. (£5).—GEORGE ROLLING, Eastwood, Notts., for *Langton Gelding*, chestnut roan gelding.

### Shires.

Class 59.—*Shire Stallions, foaled in 1906.* [9 entries, 2 absent.]

- 352 I. (£15).—JAMES GOULD, Crouchley, Lymm, for *Lymm Grey*, grey; s. Severn Bradford 24899, d. Darling by Coleshill Carbon 12893.  
 351 II. (£10).—FRANK FARNSWORTH, Tooley Park, Hinckley, for *Ratcliffe Coming King*, bay; s. Lockinge Forest King 18867, d. Ratcliffe Sunflower 37000 by Ratcliffe Royal Harold 16910.  
 349 III. (£5).—EARL EGERTON OF TATTON, Tatton Park, Cheshire, for *Tatton Settler*, bay; s. Lockinge Colonist 21609, d. Tatton Wagtail 22568 by Royal William 2nd 12207.  
 354 R. N. & H. C.—SIR P. A. MUNTZ, BT., M.P. for *Dunsmore Professor*.

Class 60.—*Shire Stallions, foaled in 1905.* [13 entries, 3 absent.]

- 363 I. (£15).—F. E. MUNTZ, Umberslade, Hockley Heath, for *King Forest* 24357, brown, bred by H. R. Craig, Welham Lodge, Market Harborough; s. Lockinge Forest King 18867, d. Lockinge Dimple 29261 by Lockinge Warrior 15700.  
 366 II. (£10, & R. N. for Special.<sup>1</sup>)—LORD ROTHSCHILD, Tring Park, Herts, for *Hotspur* 4th 24334, bay; s. Birdsall Menestrel 19337, d. Halstead Duchess 2nd 36089 by Markeaton Royal Harold 16225.  
 364 III. (£5).—SIR P. ALBERT MUNTZ, BT., M.P., Dunsmore, Rugby, for *Dunsmore President* 24208, bay, bred by Kenneth H. Wright, Yelvertoft Manor, Rugby; s. Dunsmore Jameson 17972, d. Southernwood Fiction 20871 by Blagdon Baron 12790.  
 362 R. N. & H. C.—JOHN MEASURES, Dunsby, Bourne, for *Constitution*.

Class 61.—*Shire Stallions, foaled in 1904.* [7 entries, 1 absent.]

- 372 I. (£15, & Champion.<sup>2</sup>)—FRANK FARNSWORTH, Tooley Park, Hinckley, for *Ratcliffe Forest King* 23622, bay, bred by J. L. Harrison, Pailton Fields, Rugby; s. Lockinge Forest King 18867, d. Pailton Queen 33362 by King Harold 7496.  
 373 II. (£10, & R. N. for Champion.<sup>2</sup>)—JAMES GOULD, Crouchley, Lymm, for *Lockinge Truffle* 23453, black, bred by Lady Wantage, Lockinge, Wantage; s. Lockinge Forester 19777, d. Lockinge Mary 24190 by Prince Harold 14228.  
 374 III. (£5, & Special.<sup>1</sup>)—SIR P. ALBERT MUNTZ, BT., M.P., Dunsmore, Rugby, for *Dunsmore Premier*, black, bred by the late J. Farnell, Rainsbrook, Rugby; s. Birdsall Calamint 17796, d. Rocks Ebony 28851 by Bury Victor Chiff 11105.  
 371 R. N. & H. C.—A. H. CLARK, Moulton Eaugate, Spalding, for *Moulton Floral*.

Class 62.—*Shire Fillies, foaled in 1906.*<sup>3</sup> [15 entries, 10 absent.]

- 380 I. (£15).—W. T. EVERARD, Bardon Hall, Leicester, for *Bardon Flower of the Forest*, brown; s. Lockinge Forest King 18867, d. Bardon Sweet Mary 25276 by Calwich Heirloom 14547.  
 387 II. (£10).—SIR P. ALBERT MUNTZ, BT., M.P., Dunsmore, Rugby, for *Dunsmore Quicklime*, bay, bred by J. E. Thurman, Birkholme House, Grantham; s. Dunsmore Jameson 17972, d. Monks Mabel 26510 by Carlton Banker 9017.

<sup>1</sup> Special Prize of £10, given by a Committee of Members of the London Lincolnshire Society (out of funds subscribed for the purpose), for Members of the Lincolnshire Agricultural Society only, for the best Stallion in Classes 59-61.

<sup>2</sup> Champion Gold Medal, value £10, given by the Shire Horse Society for the best Stallion in Classes 59-61.

<sup>3</sup> Prizes given by the Shire Horse Society.

lxvi *Award of Live Stock Prizes at Lincoln, 1907.*

[Unless otherwise stated, each prize animal named below was "bred by exhibitor."]

376 III. (£5.)—TOM BOND, The Lindens, Ludboro, Louth, for *Ludboro Royal Lassie*, brown; s. Lockinge Forest King 18867, d. Ludboro Quality 45613 by Double X William 13964.

384 R. N. & H. C.—F. W. GRIFFIN, Boro Fen, Peterborough, for *Boro Forest Queen*.

**Class 63.—Shire Fillies, foaled in 1905.** [13 entries, 3 absent.]

394 I. (£15.)—W. T. EVERARD, Bardon Hall, Leicester, for *Ashleigh Royal Duchess*, bay, bred by Gamble Bros., Ashleigh Farm, Braunstone; s. Lockinge Forest King 18867, d. Ashleigh Duchess 27393 by Eastern Harold 12898.

401 II. (£10.)—LORD ROTHSCHILD, Tring Park, Herts, for *Misty Morn* 51759, bay; s. Birdsall Menestrel 19337, d. Crossmoor 41519 by Crossmoor Carbon 19625.

398 III. (£5.)—EGERTON ORME, Ash, Etwall, Derby, for *Combermere Abbess* 50718, brown, bred by Noel Forwood, Burleydam, Whitechurch, Salop; s. Tatton Friar 21953, d. Moors Star 26536 by Regent 2nd 6316.

391 R. N. & H. C.—GEORGE G. ATTERBURY, West Haddon, Rugby, for *Fuchsia* 2nd.

**Class 64.—Shire Fillies, foaled in 1904.** [7 entries, 2 absent.]

405 I. (£15, & Champion.<sup>1</sup>)—W. T. EVERARD, Bardon Hall, Leicester, for *Bardon Marion*, bay, bred by J. W. Sanders, Gilmorton, Lutterworth; s. Lockinge Forest King 18867, d. Wallflower 49756 by Jeroboam 15172.

404 II. (£10.)—EARL EGERTON OF TATTON, Tatton Park, Cheshire, for *Tatton May Queen* 49580, bay, bred by Joseph Blunt, Field Farm, Barlestone, Nuneaton; s. Lockinge Forest King 18867, d. May Blossom 30574 by Bury Pilot 8943.

407 III. (£5.)—F. E. MUNTZ, Umberslade, Hockley Heath, for *Aldeby Lady Jameson* 46847, bay, bred by T. J. Cresswell, Ashby Lodge, Thurton, Norwich; s. Dunsmore Jameson 17972, d. Lady Ingham 32788 by Boscobel 15002.

410 R. N. & H. C.—SIR EDWARD STERN, Fan Court, Chertsey, for *Bardon Forest Rose*.

**Class 65.—Shire Mares, with Foals at foot.** [20 entries, 7 absent.]

424 I. (£15, Special,<sup>2</sup> & R. N. for Champion.<sup>1</sup>)—LORD ROTHSCHILD, Tring Park, Herts, for *Belle Cole* 44091, bay, foaled 1903 [foal by Birdsall Menestrel 19337], bred by W. Snaalam, Fir Tree Farm, Crossmoor, Kirkham; s. Crossmoor Carbon 19625, d. Grimsargh Beauty 32312 by Blythwood Harold 15492.

480 II. (£10.)—THE DUKE OF SUTHERLAND, K.G., Lilleshall, Newport, Salop, for *Lilleshall Moss Rose* 42512, bay, foaled 1901 [foal by Dunsmore Jameson 17972]; s. Markeaton Royal Harold 15225, d. Fancy 25962 by Scalford Hero 14857.

426 III. (£5.)—LEOPOLD SALOMONS, Norbury Park, Dorking, for *Childwick Young* 35375, bay, foaled 1900 [foal by Hendre Champion 18079], bred by the late Sir Blundell Maple, Bt., Childwickbury, St. Albans; s. Childwick Majestic 17264, d. Juno of Worsley 9th 21993 by Vulcan of Worsley 9th 13736.

417 R. N. & H. C. & R. N. for Special.<sup>2</sup>—S. E. DEAN & SONS, Dowsby Hall, Bourne, for *Roxby Starlight* 49227, black, foaled 1903 [foal by Our J.P. 20786], bred by W. Sheardown, Old Park Farm, Crosby, Doncaster; s. Sea Dog 18348, d. by Blagdon Warlike 12804.

**Class 66.—Shire Colt Foals, the produce of Mares entered in Class 65.<sup>3</sup>**

[5 entries, 1 absent.]

432 I. (£10.)—THE RT. HON. VICTOR CAVENDISH, M.P., Holker Hall, Lancs, for bay; s. Holker Menestrel 2nd 23451, d. Holker Minerva 33182 by Stalmine Premier 14877. [Exhibited with No. 414.]

431 II. (£5.)—GEORGE CARTWRIGHT & SON, Dunham-on-Trent, Newark, for bay; s. Nailstone Cour-de-Lion 16289, d. Ragdoll Depper 33567 by Sir William 13564. [Exhibited with No. 413.]

434 III. (£4, and Special.<sup>4</sup>)—LORD ROTHSCHILD, Tring Park, Herts, for bay; s. Birdsall Menestrel 19337, d. Belle Cole 44091 by Crossmoor Carbon. [Exhibited with No. 424.]

433 R. N. & H. C. & R. N. for Special.<sup>4</sup>—J. W. DAVY, Great Carlton, Louth, for bay; s. Birdsall Menestrel 19337, d. Smiler 46273 by Golden King. [Exhibited with No. 416.]

**Class 67.—Shire Filly Foals, the produce of Mares entered in Class 65.<sup>3</sup>**

[15 entries, 4 absent.]

47 I. (£10.)—SIR ALEXANDER HENDERSON, Bt., Buscot Park, Faringdon, for bay; s. Juscot Harold 16676, d. Rickford Dorothy 37033 by Calwich Prince 15531. [Exhibited with No. 421.]

47 II. (£6.)—THE DUKE OF SUTHERLAND, K.G., Lilleshall, Newport, Salop, for bay; s. Dunsmore Jameson 17972, d. Lilleshall Moss Rose 42512 by Markeaton Royal Harold 15225. [Exhibited with No. 430.]

<sup>1</sup> Champion Gold Medal, value £10, given by the Shire Horse Society for the best mare or Filly in Classes 62-65.

<sup>2</sup> Special Prize of £10 given by the Lincolnshire Agricultural Society, for Members of that Society only, for the best Brood Mare in Class 65.

<sup>3</sup> Prizes given by the Shire Horse Society.

<sup>4</sup> Special Prize of £5 given by a Committee of Members of the London Lincolnshire Society (out of funds subscribed for the purpose), for Members of the Lincolnshire Agricultural Society only, for the best Colt Foal in Class 66.

[Unless otherwise stated, each prize animal named below was "bred by exhibitor."]

- 439 III. (£4).—FRANK FARNSWORTH, Tooley Park, Hinckley, for bay; s. Ratcliffe Forest King 23622, d. Ratcliffe Sunflower 57000 by Ratcliffe Royal Harold 16010. [Exhibited with No. 419.]
- 438 E. N. & H. C.—EARL EGBERTON OF TATTON, Tatton Park, Cheshire.

### Clydesdales.<sup>1</sup>

Class 68.—*Clydesdale Stallions, foaled in 1906.* [4 entries, 3 absent.]

- 450 I. (£15).—A. & W. MONTGOMERY, Netherhall and Banks, Kirkcudbright, for black, bred by James Merson, Craigwillie, Huntly; s. Everlasting 11331, d. Jean of Craigwillie 18031 by Prince Thomas 10262.

Class 69.—*Clydesdale Stallions, foaled in 1905.* [4 entries.]

- 455 I. (£15, & Champion.<sup>2</sup>)—A. & W. MONTGOMERY, Netherhall and Banks, Kirkcudbright, for Diploma 13442, bay, bred by J. P. Sleigh, St. Johns Wells, Fyvie; s. Everlasting 11331, d. Thelma 16288 by Mains of Airies 10379.
- 454 II. (£10).—A. & W. MONTGOMERY, for Garty Bonus 13491, brown, bred by A. MacG. Mennie, Brawlandknowes, Garty; s. Everlasting 11331, d. Garty Coupon 16937 by Prince Thomas 10262.
- 453 III. (£5).—A. B. MATTHEWS, Newton Stewart, for Baron Barsalloch 13302, dark bay or brown, bred by Andrew McGill, Barsalloch, Newton Stewart; s. Baronson 10961, d. Lady Blanche of Barsalloch 16856 by Prince Sturdy 10112.
- 452 E. N. & H. C.—J. ERNEST KERR, Harviestoun, Dollar, for Harviestoun Baron.

Class 70.—*Clydesdale Stallions, foaled in 1904.* [4 entries, 1 absent.]

- 456 I. (£15, & E. N. for Champion.<sup>2</sup>)—WALTER S. PARK, Hatton, Bishopton, for Clan Forbes 12913, dark brown, bred by Harry Forbes, Muirtown of Borra, Old Meldrum; s. Royal Chattan 11489, d. Rose of Muirton by Scottish Hero 7340.
- 455 II. (£10).—A. & W. MONTGOMERY, Netherhall and Banks, Kirkcudbright, for Baron Monkton 12837, bay, bred by T. C. Lindsay, Aitkenbrae, Monkton; s. Baron's Pride 9122, d. Lady Anderson 14856 by Royal Garty 9844.
- 458 III. (£5).—A. & W. MONTGOMERY, for Pride of Avon 13653, black, bred by James Lambie, Bonnyton Moor, Eaglesham; s. Rathillet 11870, d. Lily of Bonnyton 16171 by Carthusian 9722.

Class 71.—*Clydesdale Fillies, foaled in 1905.* [6 entries, none absent.]

- 465 I. (£15, & E. N. for Champion.<sup>3</sup>)—THE SEAHAM HARBOUR STUD, LTD., Seaham Harbour, for Silver Pansy, bay, bred by George H. Procter, Flass House, Durham; s. Silver Cup 11184, d. Muriel 15784 by Gallant Prince 10552.
- 463 II. (£10).—MESSRS. MURDOCH, Hallside, Newton, Glasgow, for Royal Rosebud, bay, bred by Robert Matthews, Linns, Dumfries; s. Royal Edward 11495, d. Woodbine 15222 by Flashwood 3904.
- 461 III. (£5).—J. ERNEST KERR, Harviestoun Castle, Dollar, for Preciada, brown, bred by H. M. The King; s. Baron's Pride 9122, d. Bessie Lee 14462 by Lord Colum Edmund.
- 464 E. N. & H. C.—THE SEAHAM HARBOUR STUD, LTD., for Just Katie.

Class 72.—*Clydesdale Fillies, foaled in 1904.* [4 entries, 1 absent.]

- 468 I. (£15).—H. B. MARSHALL, Rachan, Broughton, Peebleshire, for Baron's Brilliant, bay, bred by David Hood, Balgreddau, Kirkcudbright; s. Baron's Pride 9122, d. Scottish Brilliant 14391 by Prince Frederick 8905.
- 469 II. (£10).—THE SEAHAM HARBOUR STUD, LTD., Seaham Harbour, for Silver Fern, brown; s. Silver Cup 11184, d. Flirt 11863 by The Regent 5408.

Class 73.—*Clydesdale Mares, with Foals at foot.* [2 entries.]

- 471 I. (£15, & Champion.<sup>3</sup>)—J. ERNEST KERR, Harviestoun Castle, Dollar, for Pyrene, bay, foaled 1900 [foal by Royal Favourite 10630], bred by W. P. Gilmour, Balmangan, Kirkcudbright; s. Baron's Pride 9122, d. Missie of Balmangan 14226 by Lord Erskine.
- 470 II. (£10).—GEORGE GUNTER, Wetherby Grange, Wetherby, for Silver Princess, bay, foaled 1903 [foal by Gamecock 12583], bred by The Seaham Harbour Stud, Ltd., Seaham Harbour; s. Silver Cup 11184, d. Princess Victoria 15779 by Moncreiffe Marquis 8963.

Class 74.—*Clydesdale Foals, the produce of Mares entered in Class 73.*

[2 entries.]

- 473 I. (£10).—J. ERNEST KERR, Harviestoun Castle, Dollar, for bay filly; s. Royal Favourite 10630, d. Pyrene by Baron's Pride 9122. [Exhibited with No. 471.]
- 472 II. (£6).—GEORGE GUNTER, Wetherby Grange, Wetherby, for bay colt, bred by The Seaham Harbour Stud, Ltd.; s. Gamecock 12583, d. Silver Princess by Silver Cup 11184. [Exhibited with No. 470.]

<sup>1</sup> The sum of £50 was given by the Clydesdale Horse Society towards these Prizes.

<sup>2</sup> Champion Prize of £10 given by the Clydesdale Horse Society for the best Stallion in Classes 68-70.

<sup>3</sup> Champion Prize of £10 given by the Clydesdale Horse Society for the best Mare or Filly in Classes 71-73.

## lxviii *Award of Live Stock Prizes at Lincoln, 1907.*

[Unless otherwise stated, each prize animal named below was "bred by exhibitor."]

### Suffolks.

**Class 75.—Suffolk Stallions, foaled in 1905.** [7 entries, 2 absent.]

- 479 I. (£10, & R. N. for Champion.<sup>1</sup>)—ALFRED J. SMITH, Rendlesham, Woodbridge, for **Rendlesham Major Gray** 3278, bred by Wm. Gray, Parham Hall, Wickham Market; s. Saturn 2653, d. Daisy 4398 by Sutton Swell 2686.  
 474 II. (£8.)—KENNETH M. CLARK, Sudbourne Hall, Orford, for **Sudbourne Arab** 3300; s. Sudbourne Count 3257, d. Sudbourne Arabelle 5472 by Wedgewood 1749.  
 478 III. (£4.)—A. GERALD SMITH, Great Bealings Hall, Woodbridge, for **Lord Nelson** 3315; s. Prince Albert 2525, d. Sadie 4900 by Saturn 2653.  
 476 R. N. & H. C.—KENNETH M. CLARK, for **Sudbourne Squire**.

**Class 76.—Suffolk Stallions, foaled in 1904.** [5 entries, none absent.]

- 481 I. (£15, & Champion.<sup>1</sup>)—KENNETH M. CLARK, Sudbourne Hall, Orford, for **Sudbourne Arabi** 3287, bred by A. H. E. Wood, Sudbourne Hall; s. Sudbourne Count 3257, d. Sudbourne Arabelle 5472 by Wedgewood 1749.  
 482 II. (£10.)—ARTHUR T. PRATT, Morston Hall, Trimley, Ipswich, for **Sproughton Gold Ring** 3347, bred by E. Wilson, Hadleigh; s. Golden Grain 2479, d. Gipsy 4049 by William Conqueror 2573.  
 485 III. (£5.)—R. EATON WHITE, Boulge Hall, Woodbridge, for **Boulge Mikado** 3258; s. Boulge Conqueror 2667, d. Madge 4276 by Windsor Chieftain 2025.  
 484 R. N. & H. C.—A. J. SMITH, Rendlesham, Woodbridge, for **Rendlesham Captain Gray**.

**Class 77.—Suffolk Fillies, foaled in 1905.** [6 entries, 2 absent.]

- 491 I. (£10.)—ALFRED J. SMITH, Rendlesham, Woodbridge, for **Rendlesham Wedgy** 5490 s. Saturn 2653, d. Rendlesham Wedge 4371 by Leiston Friar 2520.  
 488 II. (£8.)—A. CARLYLE SMITH, Ashmoor, Campsea Ash, Wickham Market, for **Ruby** 5640, bred by the late F. G. Cook, Saxtead Lodge, Framlingham; s. Dennington Cup-bearer 3086, d. Maude 4001 by Border Minstrel 2287.  
 486 III. (£4.)—KENNETH M. CLARK, Sudbourne Hall, Orford, for **Sudbourne Alice** 6023, bred by C. H. Berners, Woolverstone Park, Ipswich; s. Sunshine 2734, d. Alice 3680 by Russett 2127.  
 489 R. N. & H. C.—A. GERALD SMITH, Great Bealings Hall, Woodbridge, for **Dowager**.

**Class 78.—Suffolk Fillies, foaled in 1904.** [4 entries.]

- 493 I. (£10.)—KENNETH M. CLARK, Sudbourne Hall, Orford, for **Sudbourne Surprise** 5527, bred by A. T. Pratt, Morston Hall, Trimley; s. Saturn 2653, d. Winnipeg 3494 by Czar 1754.  
 492 II. (£8.)—KENNETH M. CLARK, for **Sudbourne Ruby** 5805, bred by W. Estaugh, Butley Abbey, Tunstall; s. Golden Grain 2479, d. Duchess 3784 by Sudbourne 2232.  
 494 III. (£4.)—SIR CUTHBERT QUILTER, BT., Bawdsey Manor, Woodbridge, for **Ramsholt Minnehaha** 5087; s. Napoleon 2933, d. Ramsholt Lady 4434 by Prince Wedgewood.  
 495 R. N. & H. C.—A. G. SMITH, Great Bealings Hall, Woodbridge, for **Great Scott**.

**Class 79.—Suffolk Mares, with Foals at foot.** [4 entries, 2 absent.]

- 497 I. (£15.)—A. GERALD SMITH, Great Bealings Hall, Woodbridge, for **Sadie** 4900, foaled 1901 [foal by Lord John 2716]; s. Saturn 2653, d. Where's Hoo 3946 by Queen's Diadem 1721.  
 499 II. (£10.)—R. EATON WHITE, Boulge Hall, Woodbridge, for **Boulge Hebe** 4818, foaled 1900 [foal by Boulge Monarch 3054]; s. Golden Grain 2479, d. Nectar 4177 by Emperor 1611.

### Draught Horses.<sup>2</sup>

**Class 80.—Geldings, foaled in 1905.** [1 entry.]

- 500 I. (£15.)—W. F. GLASIER, Central House, Winterton, *vid* Doncaster, for **Roxby Toge**, brown; s. Knottingly Regent.

**Class 81.—Geldings, foaled in 1904.** [3 entries.]

- 401 I. (£15.)—EDWARD DAVIES, The Walk, Partington, near Manchester, for **Partington Waggoner**, roan, bred by W. H. O. Duncombe, Wareley Park, Sandy; s. Castle Bromwich Keith 17865.  
 402 II. (£10.)<sup>3</sup>—FRED MONEY, Silk Willoughby, Sleaford, for chestnut, bred by R. A. Haywood, Elmside, Nuneaton; s. Exton Conqueror 18725.

<sup>1</sup> Challenge Cup, value Fifty Guinea, given by the Suffolk Horse Society for the best stallion in Classes 75 and 76, the Cup to become the absolute property of an Exhibitor winning it three times.

<sup>2</sup> Prizes given by the Lincoln Local Committee.

<sup>3</sup> No. 503 has succeeded to its present position through the disqualification of No. 502 (Second Prize in Class 81), which the Exhibitor subsequently discovered was foaled in 1902 and not in 1904 as stated by him at the time of entry.

[Unless otherwise stated, each prize animal named below was "bred by exhibitor."]

### ASSES.<sup>1</sup>

**Class 82.**—*Donkey Stallions, foaled in or before 1905, 13 hands and upwards.*  
[1 entry.]

504 I. (£5.)—HAROLD SESSIONS, Wootton Manor, Henley-on-Thames, for Don Eduardo, black, foaled 1905.

**Class 83.**—*Donkey Mares (with or without foals), 12 hands and upwards.*  
[2 entries.]

505 I. (£5.)—HAROLD SESSIONS, Wootton Manor, Henley-on-Thames, for Cleopatra, brown, foaled 1903.

506 II. (£2.)—HAROLD SESSIONS, for Juanita, black, foaled 1897 [foal by Don Alfonso].

## CATTLE.

### Shorthorns.

**Class 84.**—*Shorthorn Bulls, calved in 1902, 1903, or 1904.*  
[32 entries, 6 absent.]

537 I. (£10, Champion,<sup>2</sup> & Special.<sup>3</sup>)—F. MILLER, La Belen, Clifton Road, Birkenhead, for Linkfield Champion 86401, roan, born May 16, 1903, bred by Col. C. J. Johnston, Linkfield, Elgin; s. Scottish Prince 82270, d. Kathleen by John Peel 67237.

516 II. (£6.)—SIR RICHARD COOPER, BT., Shenstone Court, Lichfield, for Meteor 86631, white, born March 29, 1903, bred by C. Morgan-Richardson, Morgenau, Rhos Hill, R.S.O.; s. Moonlight 75110, d. Calluna by Major 59419.

536 III. (£4.)—J. C. TOPPIN, Musgrave Hall, Penrith, for Moonstone 86692, roan, born Feb. 28, 1903, bred by C. Morgan-Richardson, Noyadd Wilym, Cardigan; s. Moonlight 75110, d. Radiant Rose by R. A. 71293.

507 R. N. & H. C.—H.M. THE KING, Royal Farms, Windsor, for Enchanter.

**Class 85.**—*Shorthorn Bulls, calved on or between January 1 and June 30, 1905.* [55 entries, 15 absent.]

530 I. (£10, & R. N. for Champion.<sup>2</sup>)—H.M. THE KING, Royal Farms, Windsor, for Royal Windsor 85289, roan, born March 27; s. Luxury 74958, d. Remembrance by Count Lavender 60545.

551 II. (£6, & R. N. for Special.<sup>3</sup>)—ROBERT CHATTERTON, Stenigot, Lincoln, for Avondale 94085, roan, born Jan. 5, bred by J. McWilliam, Stoneytown, Mulben, Banffshire; s. Pride of Avon 86378, d. White Rose by Cornelius 66864.

562 III. (£4.)—J. DEANE WILLIS, Bapton Manor, Codford, Wilts, for Stonecrop 97297, white, born April 9, bred by Lord Brougham and Vaux, Penrith; s. Stoneytown Pride 77972, d. Furze 5th by Merry Archer 75066.

563 R. N. & H. C.—ROBERT TAYLOR, Pitlivie, Carnoustie, for Baron Lindisfarne.

**Class 86.**—*Shorthorn Bulls, calved on or between July 1 and December 31, 1905.*<sup>4</sup> [38 entries, 8 absent.]

608 I. (£10.)—JOHN HANDLEY, Green Head, Mülthorpe, for Rosedale Diamond 96830, roan, born Sept. 23; s. Parisian Diamond 86704, d. Rosedale Lady 3rd by Golden Prince 74644.

621 II. (£6.)—THE DUKE OF NORTHUMBERLAND, K.G., Alnwick Castle, Alnwick, for Alnwick Favourite 90653, roan, born Aug. 16; s. Bapton Favourite 78080, d. Baroness Rothschild by Baron Abbotsford 79087.

619 III. (£4.)—H. S. LEON, Bletchley Park, Bletchley, for Ascott Wanderer, roan, born Sept. 3, bred by Leopold de Rothschild, Ascott, Leighton Buzzard; s. Robert Bruce 77661, d. Hawford Necklace (vol. 49, p. 491) by Wanderer 60138.

564 R. N. & H. C.—HUGH BAKER, Chedglow, Malmesbury, for Chedglow Challenger.

**Class 87.**—*Shorthorn Bulls, calved on or between January 1 and June 30, 1906.* [68 entries, 13 absent.]

607 I. (£10.)—W. J. HOSKEN, Loggans Mill, Hayle, for Hayle Viceroy 95452, roan, born Jan. 11, bred by W. James, Barteliver, Grampound Road; s. Janissary 5th 83779, d. Emma Gwynne by Bridekirk Boy 2nd 66730.

661 II. (£6.)—R. R. ROTHWELL, Estate Office, Miller Arcade, Preston, for Lord Brilliant 95801, roan, born Jan. 21; s. Lord Blanche 13th 86418, d. Wallflower's Brilliant 16th by Cader Idris 76279.

<sup>1</sup> Prizes given by Breeders of Asses.

<sup>2</sup> Champion Prize of £30 given by the Shorthorn Society for the best Bull in Classes 84-86.

<sup>3</sup> Special Prize of £10 given by the Lincolnshire Agricultural Society, for Members of that Society only, for the best Bull in Classes 84-86.

<sup>4</sup> Prizes given by the Shorthorn Society.

lxx *Award of Live Stock Prizes at Lincoln, 1907.*

[Unless otherwise stated, each prize animal named below was "bred by exhibitor."]  
 697 III. (£4.)—J. DEANE WILLIS, Bapton Manor, Codford, Wilts, for **Bapton Viscount** 84146, roan, born April 13; s. Chewton Brave Archer 78578, d. Victoria Rosea by Bapton Victory 68910.

671 E. N. & H. C.—F. MILLER, La Belen, Clifton Road, Birkenhead, for **Village Purple**.

**Class 88.—Shorthorn Bulls, calved on or between July 1 and December 31, 1906.**<sup>1</sup> [20 entries, 1 absent.]

709 I. (£10.)—H. S. LEON, Bletchley Park, Bletchley, for **Bletchley King**, roan, born Sept. 29; s. Silver Mint. 79968, d. Lancaster 42nd (vol. 52, p. 872) by Bright Stone.

719 II. (£6.)—J. DEANE WILLIS, Bapton Manor, Codford, Wilts, for **Bapton Forester**, roan, born July 24; s. Violet's Fame 78078, d. Katherine by G.I.V. 80707.

715 III. (£4.)—R. B. ROTHWELL, Miller Arcade, Preston, for **Scotland Yet** 97042, roan, born Aug. 29; s. Strowan Marquis 13th 90268, d. Crocus 28th by Cyprus 66884.

713 E. N. & H. C.—OCEIL F. RAPHAEL, Porters Park, Shenley, for **Shenley Baronet**.

**Class 89.—Group Class, consisting of Bull (not necessarily bred by Exhibitor), and 2, 3, or 4 of his Male offspring, bred by Exhibitor, not less than six months old on the day of entry.** Open to animals entered in Classes 84 to 88 only.<sup>1</sup>

B. I. (£20.)—GEORGE HARRISON, Gainford Hall, Darlington, for **Royal Ensign, Gainford Ensign, Gainford Leader, and Gainford Specular**.

A. II. (£10.)—GEORGE HARRISON, for **Pioneer, Gainford Prince Albert, and Gainford Prince Henry**.

**Class 90.—Shorthorn Cows (in-milk), calved before or in 1903.**  
 [10 entries, 1 absent.]

721 I. (£10, **Champion, & Special.**)<sup>2</sup>—LORD CALTHORPE, Elvetnam Park, Winchfield, for **Sweetheart** (Vol. 52, p. 668), roan, born Dec. 29, 1900, in-milk, calved June 10, 1907, bred by Her late Majesty Queen Victoria, Royal Farms, Windsor; s. Royal Duke 75609, d. Sweetbriar by Nobleman 65968.

724 II. (£6, & E. N. for **Special.**)<sup>3</sup>—GEORGE HARRISON, Gainford Hall, Darlington, for **Towry Princess** (vol. 52, p. 782), roan, born Oct. 27, 1903, in-milk, calved Jan. 2, 1907, bred by R. Footman, Havodwen, Carmarthen; s. Cashier 68326, d. Lady Queen by Village Lad 78075.

727 III. (£4.)<sup>4</sup>—SIR A. C. STEPNEY, BT., The Dell, Llanely, for **Vesta** (vol. 52, p. 482), red and little white, born Aug. 12, 1901, in-milk, calved May 11, 1907, bred by T. A. Argles, Eversley, near Milnthorpe; s. Land Steward 81422, d. Vera by Baron Eversley 66689.

**Class 91.—Shorthorn Heifers (in-milk), calved in 1904.**<sup>1</sup> [8 entries, 1 absent.]

736 I. (£10.)—R. B. ROTHWELL, Estate Office, Miller Arcade, Preston, for **Lady Graceful**, roan, born Sept. 25, in-milk, calved April 1, 1907, bred by William Kendal, Natland Hall, Kendal; s. Farleton Chief 83463, d. White Graceful (vol. 51, p. 691) by Stanley 77954.

730 II. (£6.)—THOMAS ATKINSON, Redvales Farm, Bury, for **Takeley Jinny** (vol. 51, p. 641), roan, born Jan. 8, in-milk, calved Jan. 10, 1907; s. Chewton Victor 6th 80686 d. Jinny 18th by Lord Derwent 3rd 77050.

734 III. (£4.)—ALEXANDER T. GORDON, Combeauseway, Insch, for **Linksfeld Regina 2nd** (vol. 51, p. 686), roan, born Jan. 80, in-milk, calved April 7, 1907, bred by Col. C. J. Johnston, Linksfeld, Elgin; s. Marmion 88557, d. Linksfeld Regina by Janissary 2nd 72731.

732 E. N. & H. C.—SIR JEREMIAH COLMAN, BT., Gatton Park, Surrey, for **Snow Queen**.

**Class 92.—Shorthorn Heifers, calved in 1905.** [36 entries, 8 absent.]

760 I. (£10, & E. N. for **Champion.**)<sup>2</sup>—ROBERT TAYLOR, Pitlivie, Carnoustie, for **Pitlivie Rosebud 2nd**, roan, born April 7; s. Golden Dawn 72609, d. Rubina (vol. 52, p. 873) by Silver Wave 2nd 87368.

762 II. (£6.)—FREDERICK PHILLIPS, Shipton Sollars Manor, Andoversford, for **Ross Pansy** (vol. 52, p. 1015), roan, born Feb. 19; s. First Favour 86972, d. Shipton Pansy by Wrestler 66582.

760 III. (£4.)—THE DUKE OF NORTHUMBERLAND, K.G., Alnwick Castle, Alnwick, for **Belle of Alnwick** (vol. 52, p. 987), roan, born July 7; s. Bapton Favourite 76080, d. Leading Belle by The Leader 66428.

655 E. N. & H. C.—SIR ALEXANDER HENDERSON, BT., for **Buscot Smilax**.

<sup>1</sup> Prizes given by the Shorthorn Society.

<sup>2</sup> Champion Prize of £30 given by the Shorthorn Society for the best Cow or Heifer

Classes 90-96.

Special Prize of £10, given by the Lincolnshire Agricultural Society, for Members of

nat Society only, for the best Cow or Heifer in Classes 90-98.

<sup>4</sup> No. 727 has succeeded to her present position by the disqualification, through non-compliance with the regulation as to date of calving, of No. 728 (Third Prize in Class 90).

[Unless otherwise stated, each prize animal named below was "bred by exhibitor."]

**Class 93.—Shorthorn Heifers, calved in 1906.** [52 entries, 6 absent.]

- 774 I. (£10).—H.M. THE KING, Royal Farms, Windsor, for **Marjorie**, roan, born Jan. 23 & Royal Chieftain 84587, d. Miriam (vol. 51, p. 374) by Merry Harbinger 73066.  
 810 II. (£6).—EARL MANVERS, Holme Pierrepont, Nottingham, for **Duchess of Ruddington 6th**, roan, born Feb. 9, bred by the Exors. of the late Philo L. Mills, Ruddington, Nottingham; s. King Christian of Denmark 86316, d. Duchess of Ruddington 3rd (vol. 52, p. 930) by Marengo's Duke of Oxford 75004.  
 798 III. (£4).—ALFRED A. HALEY, Whitewall, Malton, for **Whitewall Emma 2nd**, red and little white, born Feb. 6; s. Sir George 77891, d. Sunflower 12th (vol. 52, p. 751) by Golden Star 76790.  
 807 R. N. & H. C.—W. J. HOSKEN, Loggans Mill, Hayle, for **Hayle Gwynne**.

**Class 94.—Shorthorn Dairy Cows (in-milk), calved before or in 1902, entered or eligible for entry in Coates's Herd Book.**<sup>1</sup> [14 entries, 3 absent.]

- 829 I. (£10, & Champion.<sup>2</sup>)—C. R. W. ADEANE, Babraham Hall, Cambridge, for **Priceless Princess** (vol. 52, p. 449), red and white, born Feb. 10, 1902, in-milk, calved June 9, 1907; s. Golden Noble 78986, d. Princess Baglan by Crown Prince 60566.  
 830 II. (£6, & R. N. for Champion.<sup>2</sup>)—G. W. TYSER, Oakfield, Mortimer, for **Lady Lee 21st** (vol. 52, p. 1174), roan, born Jan. 1, 1902, in-milk, calved April 23, 1907, bred by F. P. Bulley, Marston Hill, Fairford; s. Dowsby Kirklevington Duke 3rd 76615, d. Lady Lee 15th by Trafalgar 2nd 71732.  
 832 III. (£4).—LORD ROTHSCHILD, Tring Park, Herts, for **Dorothy** (vol. 48, p. 798), red, born April 25, 1901, in-milk, calved April 3, 1907; s. Wild Roy 78182, d. Darlington Cranford 4th by Lord Somerset Furbelow 66855.  
 834 R. N. & H. C.—LORD ROTHSCHILD, for **Warwickshire Hettie**.

**Class 95.—Shorthorn Dairy Cows (in-milk), calved in 1903, entered or eligible for entry in Coates's Herd Book.**<sup>1</sup> [8 entries, 3 absent.]

- 845 I. (£10).—LORD ROTHSCHILD, Tring Park, Herts, for **Decentia 25th** (vol. 50, p. 883), roan, born August 20, in-milk, calved April 15, 1907; s. Magna Charta 77166, d. Decentia 24th by Theodore 69704.  
 846 II. (£6).—REUBEN SHELTON, Grange Farm, Ruddington, Nottingham, for **Alstoe Beauty** (vol. 50, p. 892), red, born Feb. 11, in-milk, calved June 9, 1907; s. Marathon 79352, d. Mercote Lavender Princess by Canley Lavender Prince 74190.  
 842 III. (£4).—LORD CALTHORPE, Elvetham Park, Winchfield, for **Lady Brailes 17th**, roan, born Aug. 15, in-milk, calved March 2, 1907, bred by W. H. Tremaine, Sherborne, Northleach; s. Scottish Monarch 77828, d. Lady Brailes 3rd by Wiltshire Star 63566.  
 844 R. N. & H. C.—LORD ROTHSCHILD, for **Conishead Barrington**.

**Class 96.—Shorthorn Dairy Heifers (in-milk), calved in 1904, entered or eligible for entry in Coates's Herd Book.**<sup>3</sup> [7 entries, 2 absent.]

- 854 I. (£10).—THE MARQUIS OF WINCHESTER, Ampport St. Mary's, Andover, for **Ampport Ursulina** (vol. 52, p. 1210), red and little white, born Nov. 5, in-milk, calved March 3, 1907; s. Scratton Monk 84880, d. Ursulina 17th by Reuben 64657.  
 852 II. (£6).—LORD ROTHSCHILD, Tring Park, Herts, for **Dusky** (vol. 51, p. 908), red and white, born Aug. 12, in-milk, calved May 10, 1907; s. Baron Bates 82779, d. Danson by Magna Charta 77166.  
 851 III. (£4).—T. F. ROSKRUGE, Tehidy Barton, Camborne, for **Carnation** (vol. 52, p. 1067), roan, born June 25, in-milk, calved May 20, 1907; s. Sherborne Count 84762, d. Clematis by Pentilly 71142.  
 848 R. N. & H. C.—C. R. W. ADEANE, Babraham Hall, Cambridge, for **Babraham Daisy**.

**Class 97.—Milk Yield Prizes, open to Shorthorn Cows and Heifers entered in Classes 90, 91, 94, 95, and 96 only.** [12 entries, 2 absent.]

- 834 I. (£10).—LORD ROTHSCHILD, Tring Park, Herts, for **Warwickshire Hettie**, roan, born July 15, 1899, in-milk, calved April 21, 1907, bred by J. Cave, Priory Farm, Wolston, Coventry; s. Milverton 7th 75094, d. Warwickshire Laas 2nd by Lord Waterloo Blanche 67403.  
 831 II. (£6).—TOM HUNTER, Stone Row Head Farm, Lancaster, for **May Duchess**, roan, born May 2, 1901, in-milk, calved May 21, 1907, bred by M. & J. Bennett, Walthwaite, Threlkeld; s. Pearl Victor 79534, d. Fairy Duchess by Right Sort 73419.  
 829 III. (£4).—C. R. W. ADEANE, for **Priceless Princess**. (See Class 94.)  
 828 R. N. & H. C.—C. R. W. ADEANE, for **Ingram's Rose**.

<sup>1</sup> Prizes given by the Shorthorn Society.

<sup>2</sup> Champion Prize of £10 given by the Dairy Shorthorn (Coates's Herd Book) Association for the best animal in Classes 94-96.

<sup>3</sup> Prizes given by the Dairy Shorthorn (Coates's Herd Book) Association.

lxxii *Award of Live Stock Prizes at Lincoln, 1907.*

[Unless otherwise stated, each prize animal named below was "bred by exhibitor."]

**Lincolnshire Red Short-horns.<sup>1</sup>**

*N.B.—In the Lincolnshire Red Short-horn Classes, the number inserted within brackets after the name of an animal indicates that the animal is entered in Coates's Herd Book. A number without brackets indicates that the animal is registered in the Lincolnshire Red Short-horn Herd Book.*

**Class 98.—Lincolnshire Red Short-horn Bulls, calved before 1903.**

[5 entries.]

- 866 I. (£10.)—JOHN LANGHAM, Park Valley, Nottingham, for Brandon Blend 2266, born July 27, 1902; s. Brandon Lord Chancellor 2121, d. by Bigby 319.  
 865 II. (£6.)—ROBERT CHATTERTON, Stenigot, Lincoln, for Under Ferter 3126, born April 13, 1901, bred by W. Chatterton, Hallington, Louth; s. Saltfleet Assent 1671, d. by Red Prince 211.  
 866 III. (£4.)—S. CRAWLEY, Hemington, Oundle, for Weston Monarch 2nd 3144, born March 12, 1902, bred by W. J. Atkinson, Weston St. Mary, Spalding; s. Red Monarch (77005), d. Weston Charm by Pippins Pride (71157).  
 869 IV. (£3.)—GEORGE E. SANDARS, Scampton House, Lincoln, for Keddington Ruby 1243, born Feb. 26, 1896, bred by E. H. Cartwright, Keddington, Louth; s. Bigby 319, d. by Commodore 81.  
 867 R. N. & H. C.—JOHN DRAKES, Tathwell Grange, Louth, for Grange Captain.

**Class 99.—Lincolnshire Red Short-horn Bulls, calved in 1903 or 1904.**

[8 entries, 1 absent.]

- 866 I. (£10, Champion,<sup>2</sup> & Special.<sup>3</sup>)—BENJAMIN ROWLAND, Ivy House, Wainfleet, for Scampton Exile 4092, born March, 1904, bred by G. E. Sandars, Scampton House, Lincoln; s. Keddington Ruby 1243, d. by King Hal 156.  
 860 II. (£6.)—W. J. ATKINSON, Weston St. Mary, Spalding, for Weston Monarch 4th 4187, born April 24, 1904; s. Royal Crest (82149), d. Weston Charm by Pippins Pride (71157).  
 867 III. (£4.)—JOHN SEARBY, Croft, Wainfleet, for Croft Aubourne 4326, born April 30, 1904; s. Calceby Marvel 2453, d. by Royal James (54972).  
 864 IV. (£3.)—CHARLES T. GARLAND, Moreton Morrell, Warwick, for Surfleet Baronet 4127, born Jan. 1, 1904, bred by the late Alfred Smith, Surfleet, Lincs; s. Surfleet Baron 2666, d. Surfleet Erena by Lord Fairfax 13th 1725.  
 861 R. N. & H. C.—ROBERT CHATTERTON, Stenigot, Lincoln, for Hagnaby Admiral.

**Class 100.—Lincolnshire Red Short-horn Bulls, calved in 1906.**

[9 entries, none absent.]

- 876 I. (£10, R. N. for Champion,<sup>2</sup> & R. N. for Special.<sup>3</sup>)—GEORGE E. SANDARS, Scampton House, Lincoln, for Brandon Grenadier 4274, born Feb. 4, bred by John Langham, The Park, Nottingham; s. Brandon Lord Chief Justice 2425, d. Brandon Nonpareil by Chancellor 332.  
 871 II. (£6.)—ROBERT CHATTERTON, Stenigot, Lincoln, for Stenigot Violet Chief, born May 25, bred by R. & R. Chatterton; s. Red Chief 2611, d. Stenigot Violet 6th by Sirdar 1676.  
 872 III. (£4.)—J. DREWERY & SON, Wikes Manor House, Donington, Spalding, for Donington Baron 4355, born July 20, bred by the late Alfred Smith, Surfleet; s. Surfleet Baron 2666, d. Surfleet Daisy by Lord Fairfax 13th 1925.  
 869 IV. (£3.)—H. W. BLUNT, Brendon-on-the-Hill, Ashby-de-la-Zouch, for Brendon Champion, born Oct. 1, bred by the late T. B. Freshney, South Somercotes; s. Saltfleet Bonus 3582, d. by Grandad 1561.  
 874 R. N. & H. C.—CAPT. E. M. GRANTHAM, West Keal, Spilsby, for Keal Elois.

**Class 101.—Lincolnshire Red Short-horn Bulls, calved in 1906.**

[11 entries, 1 absent.]

- 878 I. (£10.)—ROBERT CHATTERTON, Stenigot, Lincoln, for Stenigot Duchess Beau, born Feb. 3; s. Stenigot Beau 2nd 4107, d. Stenigot Duchess 10th by Sirdar 1676.  
 880 II. (£6.)—JOHN EVENS, Burton, Lincoln, for Burton Hermit 2nd, born May 7; s. Burton Hermit 3783, d. Saltfleet Favourite by Grandad 1561.  
 878 III. (£4.)—JOHN LANGHAM, Park Valley, Nottingham, for Brandon Grenadier 2nd, born April 21; s. Brandon Majestic 2nd 4276, d. Brandon Nonpareil by Chancellor 332.  
 866 IV. (£3.)—THOMAS TURNER, Harpswell, Lincoln, for Harpswell Baron 4867, born March 2; s. Horkstow Herald 3918, d. Harpswell Amiable by Poolham Tom 195.  
 879 R. N. & H. C.—J. G. WILLIAMS, Pendley Manor, Tring, for Bonby Excursionist 4th.

A sum of £193 was given by the Lincolnshire Red Short-horn Association towards these Prizes.

<sup>1</sup> Champion Prize of £10 given by the Lincolnshire Red Short-horn Association for the best Bull in Classes 98-101.

<sup>2</sup> Special Prize of £10 given by the Lincolnshire Agricultural Society, for Members of that Society only, for the best Bull in Classes 98-101.



[Unless otherwise stated, each prize animal named below was "bred by exhibitor."]

**Class 102.—Lincolnshire Red Short-horn Cows (in-milk), calved before or in 1903.**

[6 entries, none absent.]

- 893 I. (£10).—J. G. WILLIAMS, Pendley Manor, Tring, for Nonpareil 9th, born Feb. 9, 1901, in-milk, calved Jan. 18, 1907, bred by E. H. Cartwright, Keddington Grange, Louth; s. Conisholme Boy 347, d. Nonpareil 3rd by Worlabby Lad 289.
- 892 II. (£8).—JOHN TODD, Kirkby Green, Lincoln, for Kirkby Nonpareil (vol. 10, p. 212), born March 21, 1903, in-milk, calved March 29, 1907; s. Benniworth 4th 629, d. Nonpareil 2nd by Ludford 172.
- 890 III. (£4).—GEORGE MARRIS, Kirmington, Brocklesby, for Keddington Pearl, born Feb. 20, 1900, in-milk, calved Oct. 29, 1906, bred by E. H. Cartwright, Keddington Grange, Louth; s. Bigby 319, d. Keddington Sapphire by Saltfleet Sappy 502.
- 889 VI. (£3).—FLETCHER & ANDREWS, Horninghold, Uppingham, for Olara, born 1899, in-milk, calved May 20, 1907, bred by H. T. Hincks, Wigston Hall, Leicester; s. The Bard 966, d. by Primus 901.
- 891 R. N. & H. C.—FRED SOORER, Nettleham Lodge, Lincoln, for Bracebridge 90th.

**Class 103.—Lincolnshire Red Short-horn Cows, with Calves.**

[7 entries, 1 absent.]

- 900 I. (£10, & Champion.<sup>1</sup>)—J. G. WILLIAMS, Pendley Manor, Tring, for Keddington Skipworth 5th, born March 31, 1902, bred by E. H. Cartwright, Keddington Grange, Louth; s. Benniworth 4th 629, d. Keddington Skipworth 3rd (vol. 8, p. 141) by Bigby 319.
- 894 II. (£8).—ROBERT CHATTERTON, Stenigot, Lincoln, for Cropwell Laura (vol. 8, p. 155), born Feb. 16, 1901, bred by J. Marriott, Cropwell Butler, Nottingham; s. Lincoln Sailor 1597, d. Cropwell Ladylike by Leadenham Marksman 825.
- 896 III. (£4).—J. W. FARROW & SONA, Strubby Manor, Alford, for Strubby Red Lady 2nd, born Oct. 20, 1901; s. Red Curly Coat 923, d. Thick Flesh by Weighty Tom 2nd 558.
- 895 IV. (£3).—JOHN EVENS, Burton, Lincoln, for Burton Scarlet, born in 1902, bred by Mr. Spencer, Faldingworth; s. Scarlet Cloth 5101.
- 898 R. N. & H. C.—J. F. RAWNSLEY, Candlesby, Burgh, for Cherry Ripe.

**Class 104.—Lincolnshire Red Short-horn Heifers (in-milk), calved in 1904.**

[5 entries.]

- 904 I. (£10, & R. N. for Special.<sup>2</sup>)—GEORGE MARRIS, Kirmington, Brocklesby, for Keddington Favourite 4th, born March 1, in-milk, calved March 9, 1907, bred by E. H. Cartwright, Keddington Grange, Louth; s. Vanguard 2991, d. Keddington Favourite 3rd by Conisholme Boy 347.
- 905 II. (£8).—COL. C. A. SWAN, C.M.G., Sauathorpe Hall, Spilsby, for Twilight, born Feb. 20, in-milk, calved Dec. 6, 1906, bred by E. H. Cartwright, Keddington Grange, Louth; s. Vanguard 2991, d. Starlight by The Count 1396.
- 901 III. (£4).—THE EXORS. OF THE LATE T. B. FRESHNEY, South Somercotes, Louth, for Saltfleet Poppy, born Jan. 20, in-milk, calved May 23, 1907, bred by J. W. Needham, South Cockerington, Louth; s. Benniworth 4th 629.
- 903 IV. (£3).—JOHN LANGHAM, Park Valley, Nottingham, for Brandon Red Rose (vol. 11, p. 193), born May 29, in-milk, calved Feb. 28, 1907; s. Stroxtan Victor (82420), d. Louth Rose.
- 902 R. N. & H. C.—C. HENSMAN & SON, Fulleby Grange, Horncastle, for Lapwater A.

**Class 105.—Lincolnshire Red Short-horn Heifers, calved in 1905.**

[10 entries, 2 absent.]

- 907 I. (£10).—W. J. ATKINSON, Weston St. Mary, Spalding, for Weston Pink, born in August, bred by the late R. Mowbray, Gosberton, Spalding; s. Clan Macdonald (78597), d. by Hallington Sirdar 1898.
- 906 II. (£8).—EDWARD ABRAHAM, Otby House, Market Rasen, for Otby Glitters 2nd, born May 7; s. Dunsby Sentinel 1535, d. Otby Glitters (vol. 10, p. 176) by Otby Red 879.
- 910 III. (£4).—THE REPRESENTATIVES OF THE LATE G. LAUGHTON, Belchford, Horncastle, for heifer, born Aug. 24, bred by the late G. Laughton; s. Norbury Cato 2093, d. by Saltfleet Ruby Chief 944.
- 914 IV. (£3).—BENJAMIN SIMONS, The Grange, Willoughby, Alford, for Trusthorpe Fairy, born Feb. 19, bred by W. Goddard, Ravenscourt, The Park, Nottingham; s. Buscot Loyalty 80591, d. Deeping Fairy by Anderby Champion 1753.
- 915 R. N. & H. C.—J. G. WILLIAMS, for Keddington Skipworth 7th.

**Class 106.—Lincolnshire Red Short-horn Heifers, calved in 1906.**

[29 entries, 3 absent.]

- 918 I. (£10, Special.<sup>2</sup>, & R. N. for Champion.<sup>1</sup>)—EDWIN BOURNE, 13 George Street, Louth, for Ruby Queen, born April 27; s. Saltfleet Bonus 3582, d. Ruby 12th by Benniworth 4th 629.

<sup>1</sup> Champion Prize of £10 given by the Lincolnshire Red Short-horn Association for the best Cow or Heifer in Classes 102-108.

<sup>2</sup> Special Prize of £10 given by the Lincolnshire Agricultural Society, for Members of that Society only, for the best Cow or Heifer in Classes 102-108.

lxxiv *Award of Live Stock Prizes at Lincoln, 1907.*

[Unless otherwise stated, each prize animal named below was "bred by exhibitor."]

- 923 II. (£6.)—J. W. FARROW & SONS, Strubby Manor, Alford, for *Cardiff 3rd*, born June 20; s. Under Porter 3126, d. Cardiff 2nd by Ormsby Baronet 2nd 2283.  
 927 III. (£4.)—GEORGE FREIR, Toilethorpe House, Deeping St. Nicholas, Spalding, for *Deeping Princess*, born March 18, bred by J. Bowser, Frithville, Boston; s. Scampton Exclusion 4088, d. by Smethwick Prince 1678.  
 929 IV. (£3.)—THE EXONS, OF THE LATE T. B. FRESHNEY, South Somercotes, Louth, for *Saltfleet Blooming*, born March 30, bred by E. H. Cartwright, Keddington Grange, Louth; s. Stenigot Bloom Boy 3611, d. Kennington Stamp 2nd by Benniworth 4th 629.

936 E. N. & H. C.—JOHN LANGHAM, Nottingham, for *Brandon Ruby Nonparel*.

**Class 107.—Lincolnshire Red Short-horn Cows (in-milk), calved before or in 1903, showing the best milking properties.** [8 entries, 1 absent.]

- 947 I. (£10.)—JOHN EVENS, Burton, Lincoln, for *Burton Ruddy 5th* (vol. 11, p. 191), born Oct. 8, 1901, in-milk, calved May 5, 1907; s. Red Rover (77618), d. Burton Ruddy 3rd by Burton Buttery (83741).  
 948 II. (£8.)—JOHN EVENS, for *Burton Spot 5th*, born March 23, 1903, in-milk, calved April 20, 1907; s. Red Rover (77618), d. Burton Spot 3rd by Burton Jumbo 46.  
 949 III. (£4.)—JOHN EVENS, for *Burton Violet*, born in Feb. 1900, in-milk, calved May 4, 1907, bred by J. Wells, Withern; s. Stamp End 247.  
 945 IV. (£3.)—MISS K. CARLETON, Gilford Castle, Co. Down, for *Burton Young Cherry* (vol. 9, p. 174), born Nov. 18, 1899, in-milk, calved May 28, 1907, bred by John Evens, Burton, Lincoln; s. Butter Boy 1477, d. Burton Cherry by Khartoum 3rd 154.  
 946 E. N. & H. C.—JOHN EVENS, for *Burton Cork 3rd*.

**Class 108.—Lincolnshire Red Short-horn Heifers (in-milk), calved in 1904, showing the best milking properties.** [4 entries.]

- 953 I. (£10.)—JOHN EVENS, Burton, Lincoln, for *Burton Margaret 3rd*, born Aug. 22, in-milk, calved May 31, 1907; s. Saltfleet Daring 2820, d. Margaret.  
 955 II. (£8.)—JOHN EVENS, for *Burton Prophetess 5th*, born Sept. 10, 1904, in-milk, calved June 4, 1907; s. Burton Rex 2131, d. Burton Prophetess 2nd (vol. 9, p. 272) by Knight of Chewton (68867).  
 954 III. (£4.)—JOHN EVENS, for *Burton Marjorie 3rd*, born Aug. 12, in-milk, calved May 13, 1907; s. Burton Rex 2131, d. Burton Marjorie by Greetham 393.  
 956 IV. (£3.)—JOHN EVENS, for *Burton Ruddy 6th*.

**Class 109.—Milk Yield Prizes, open to Lincolnshire Red Short-horn Cows and Heifers entered in Classes 102, 103, 104, 107, and 108 only.**

[13 entries, 1 absent.]

- 888 I. (£10.)—JOHN EVENS, Burton, Lincoln, for *Burton Vic 2nd* (vol. 9, p. 173), born Aug. 27, 1898, in-milk, calved March 21, 1907; s. Knight of Chewton (68867), d. Vic by Fox 122.  
 949 II. (£8.)—JOHN EVENS, for *Burton Violet*. (See Class 107.)  
 945 III. (£4.)—MISS K. CARLETON, for *Burton Young Cherry*. (See Class 107.)  
 951 IV. (£3.)—FRED SCORER, Nettleham Lodge, Lincoln, for *Bracebridge 117th* (vol. 9, p. 186), born Aug. 15, 1900, in-milk, calved May 11, 1907; s. Bracebridge Prince Charming 1788, d. Bracebridge 67th by Reepham Prince 486.  
 946 E. N. & H. C.—JOHN EVENS, for *Burton Cork 3rd*.

## Herefords.<sup>1</sup>

**Class 110.—Hereford Bulls, calved in 1902, 1903, or 1904.**

[6 entries, 2 absent.]

- 960 I. (£10, & Champion<sup>2</sup>.)—ALLEN E. HUGHES, Wintercott, Leominster, for *Pearl King 24192*, born April 7, 1904, bred by the late J. H. Arkwright, Hampton Court, Leominster; s. Commandant 22040, d. Pearl 15th by Montezuma 18496.  
 957 II. (£6.)—H. M. THE KING, Royal Farms, Windsor, for *Admiral 23256*, born Jan. 19, 1903; s. Earlsfield 19387, d. Angelica by Grove Prince 16745.  
 958 III. (£4.)—THE EARL OF COVENTRY, Croomer Court, Severn Stoke, for *Lama 23550*, born March 20, 1903; s. Fortunio 21396, d. Ladylove by Royal Ruler 13406.  
 961 E. N. & H. C.—J. ROWLANDS, Evenbatch Court, Bishops Frome, for *Royal Standard*.

**Class 111.—Hereford Bulls, calved in 1905.** [17 entries, 9 absent.]

- 968 I. (£10, & R. N. for Champion<sup>2</sup>.)—HENRY J. DENT, Perton Court, Stoke Edith, for *Perton 24862*, born Jan. 23; s. Whitfield Roberts 21880, d. Lively 27th by Pearl Cross.  
 971 II. (£6.)—G. D. FABER, C.B., M.P., Rush Court Wallingford, for *Bob Roy 24953*, born Feb. 17, bred by W. Tudge, Summer Court, Kington; s. Commandant 22040, d. Golden Blossom by Goldbox 15339.

<sup>1</sup> The sum of £29 was given by the Hereford Herd Book Society towards these Prizes.

<sup>2</sup> Champion Prize of £10 10s. given by the Hereford Herd Book Society for the best Bull in Classes 106-108.

[Unless otherwise stated, each prize animal named below was "bred by exhibitor."]

970 III. (£4.)—H. R. EVANS, Court of Noka, Staunton-on-Arrow, for *Pyon Gauntlet* 24910, born April 2; s. Gilderoy 20653, d. Ringdove by Endall Groves Hope 17246.

972 R. N. & H. C.—PRYCE E. HUGHES, Gresty, Crewe, for *Lowland Provisor*.

**Class 112.—Hereford Bulls, calved in 1906.** [21 entries, 7 absent.]

961 I. (£15.)—CHARLES T. PULLEY, Lower Eaton, Hereford, for *Eaton Masterpiece*, born Feb. 13; s. Eaton Champion 21351, d. Primrose (vol. 35, p. 618) by Eaton Defender 12th 20602.

962 II. (£8.)—GEORGE BUTTERS, Hill House, Newton, Hope-under-Dinmore, Leominster, for *Viscount*, born Jan. 8; s. Scot 23134, d. Prairie Snowdrop (vol. 37, p. 286) by Prairie Star 15567.

1000 III. (£4.)—A. P. TURNER, The Leen, Pembridge, for *Milton*, born Jan. 24; s. Lord Lieutenant 22323, d. Milly (vol. 37, p. 783) by Marplot 13963.

967 IV. (£2.)—D. A. THOMAS, M.P., Llanwern Park, Newport, Mon., for *Samson*, born Jan. 4, bred by W. Thomas, The Hayes, Sully; s. Perfection 22640, d. *Damson* (vol. 37, p. 757) by Bollingbroke 2nd 17688.

969 R. N. & H. C.—W. B. TUDGE, Stepside, Onibury, for *Royal Prince*.

**Class 113.—Hereford Cows or Heifers (in-milk), calved before or in 1904.** [6 entries, 3 absent.]

1003 I. (£10.)—H. R. EVANS, Court of Noka, Staunton-on-Arrow, for *Ma Belle*, (vol. 35, p. 307), born Jan. 20, 1903, in-milk, calved Feb. 23, 1907; s. Lord Sutton 20162, d. Molly by Manager 19580.

1002 II. (£6.)—THE EARL OF COVENTRY, Croome Court, Severn Stoke, for *Madame* (vol. 37, p. 337), born March 4, 1898, in-milk, calved Jan. 19, 1907; s. Viscount 18648, d. Madonna 2nd by Missionary 18857.

1004 III. (£4.)—JOSEPH ROWLANDS, Evesbatch Court, Bishops Frome, for *Hendre Bountiful* (vol. 37, p. 697), born Feb. 6, 1901, in-milk, calved Dec. 29, 1906, bred by Lord Llangatock, The Hendre, Monmouth; s. Rougemont 20296, d. Bountiful 4th by Albion 15027.

**Class 114.—Hereford Heifers, calved in 1905.** [8 entries, 3 absent.]

1014 I. (£10.)—W. B. TUDGE, Stepside, Onibury, for *Princess Beatrice* (vol. 37, p. 778), born Jan. 27; s. All-fours 22897, d. Beatrice 19th by Montezuma 13488.

1008 II. (£6.)—GEORGE BUTTERS, Hill House, Newton, Hope-under-Dinmore, Leominster, for *Newton Belle* (vol. 37, p. 294), born Jan. 1; s. Scot 23134, d. Plum by Abductor 17638.

1007 III. (£4.)—FRANK BIBBY, Hardwicke Grange, Shrewsbury, for *Clive Lilac* (vol. 37, p. 250), born Dec. 6; s. Templemore 23787, d. Lily of the Valley by Eminence 18822.

1010 R. N. & H. C.—J. R. HILL, Orleton Court, R.S.O., for *Alice*.

**Class 115.—Hereford Heifers, calved in 1906.** [12 entries, 7 absent.]

1022 I. (£10, & Champion.<sup>1</sup>)—ALLEN E. HUGHES, Wintercott, Leominster, for *Lemster Plum*, born Jan. 20; s. Pearl King 24192, d. Ivington Plum (vol. 35, p. 444) by Malcolm.

1023 II. (£6, & R. N. for Champion.<sup>1</sup>)—REES KEENE, Llanvihangel Court, Rogiet, Newport Mon., for *Bloom*, born Jan. 31; s. Whittern Marksman 23837, d. Blush (vol. 37, p. 529) by Rodney Stone 19692.

1024 III. (£4.)—JOSEPH ROWLANDS, Evesbatch Court, Bishops Frome, for *Evesbatch Beauty*, born Jan. 14; s. Royal Standard 24280, d. Hendre Bountiful (vol. 37, p. 697) by Rougemont 20296.

1018 R. N. & H. C.—FRANK BIBBY, Hardwicke Grange, Shrewsbury, for *Clive Purity*.

## Devons.

**Class 116.—Devon Bulls, calved in 1902, 1903, 1904, or 1905.**

[10 entries, 1 absent.]

1034 I. (£10, & Champion.<sup>2</sup>)—THE HON. E. W. B. PORTMAN, Hestercombe, Taunton, for *Pound Pink'un* 5350, born Jan. 4, 1903, bred by the late A. C. Skinner, Pound Farm, Bishop's Lydeard; s. Councillor 3407, d. Pink 17th 19064 by Wilcombe 3679.

1035 II. (£6, & R. N. for Champion.<sup>2</sup>)—J. C. WILLIAMS, Caerhays Castle, Gorran, R.S.O., for *Dianthus* 4961, born Feb. 6, 1903; s. Dramatist 4015, d. Blooming Cow 6th 14281 by Whitehall 2175.

1028 III. (£4.)—C. L. HANCOCK, Manor Farm, Cothelstone, Taunton, for *Eufus* 5370, born Oct. 30, 1903, bred by R. D. Hancock, Halse, Taunton; s. Tostig 4680, d. Lady Bright 3rd 17557 by Councillor 3407.

1029 R. N. & H. C.—SAMUEL KIDNER, Bickley, Milverton, for *Bickley Quaker*.

<sup>1</sup> Champion Prize of £10 10s. given by the Hereford Herd Book Society for the best Cow or Heifer in Classes 113-115.

<sup>2</sup> Champion Prize of £10 10s. given by the Devon Cattle Breeders' Society for the best Bull in Classes 116 and 117.

## lxxvi Award of Live Stock Prizes at Lincoln, 1907.

[Unless otherwise stated, each prize animal named below was "bred by exhibitor."]

**Class 117.—Devon Bulls, calved in 1906.** [6 entries, 2 absent.]

- 1037 I. (£10).—H.M. THE KING, Royal Farms, Windsor, for *Ohlstaftin*, born March 29; s. Ben Golsoncott 4343, d. Clampt Queen 19797 by The Duke 4678.  
1040 II. (£6).—THE HON. E. W. B. PORTMAN, Hestercombe, Taunton, for *Hestercombe Baronet*, born May 29; s. Caesar 5174, d. Belinda 5th 17694 by Curly King 3362.  
1042 III. (£4).—J. C. WILLIAMS, Caerhays Castle, Gorran, R.S.O., for *Lupin*, born Feb. 7; s. Drosera 4565, d. Loo Golsoncott 17118 by Joe Golsoncott 3901.  
1041 R. N. & H. C.—THE HON. E. W. B. PORTMAN, for *Hestercombe Flip*.

**Class 118.—Devon Cows or Heifers (in-milk), calved before or in 1904.**  
[7 entries, 1 absent.]

- 1048 I. (£10, & Champion.<sup>1</sup>)—E. C. NORRISH, Sandford, Crediton, for *Capton Royal Sally* 18867, born April 21, 1904, in-milk, calved March 30, 1907, bred by A. Bowerman, Capton, Williton, Somerset; s. Royalist 2nd of Pound 3807, d. Sally 15571 by Starlight.  
1045 II. (£6).—C. L. HANCOCK, Manor Farm, Cothelstone, Taunton, for *Pollie* 20746, born Oct. 6, 1901, in-milk, calved May 1, 1907, bred by J. F. Hill, Woodlands, Wivelscombe; s. Pixford Hellings 4091, d. Nell by Sportsman 4110.  
1043 III. (£4).—H.M. THE KING, Royal Farms, Windsor, for *Lucy* 18900, born Feb. 10, 1904, in-milk, calved June 5, 1907; s. Benedictine 4141, d. Lovely 5th 13857 by Lord Currypool 2nd 2618.  
1049 R. N. & H. C.—THE HON. E. W. B. PORTMAN, Hestercombe, Taunton, for *Tellata*.

**Class 119.—Devon Heifers, calved in 1905 or 1906.**  
[12 entries 2 absent.]

- 1053 I. (£10, & R. N. for Champion.<sup>1</sup>)—TOM DIBBLE, Bagborough, Taunton, for *Lady Escott* 4th 20657, born May 9, 1905; s. Councillor 3407, d. Lady Escott 2nd 18788 by True Blue 4121.  
1057 II. (£6).—CHARLES MORRIS, Highfield Hall, St. Albans, for *Pound Brassy* 15th 21616, born April 20, 1906, bred by the late A. C. Skinner, Pound, Bishop's Lydeard; s. Royal Charter 4488, d. Pound Brassy 7th 18454 by Merryman 4082.  
1051 III. (£4).—ELAND CLATWORTHY, Outsey, Wellington, Somerset, for *Outsey Beauty* 21274, born Jan. 23, 1906; s. Bickley Opal 4533, d. Brassy 5th 18720 by Duke of Thorverton 4338.  
1059 R. N. & H. C.—THE HON. E. W. B. PORTMAN, for *Cothelstone Patience*.

## South Devons.<sup>2</sup>

**Class 120.—South Devon Bulls, calved in 1902, 1903, 1904, or 1905.**  
[3 entries.]

- 1064 I. (£10).—J. SPARROW WROTH, Coombe, Aveton-Gifford, for *Macbeth* 1924, born May 10, 1903; s. Duke of York 1439, d. Netta 3rd 3653 by Marmion 631.  
1062 II. (£6).—FRED W. ROWE, Trevego, Lostwithiel, for *Odd Character* 1708, born May 9, 1902, bred by J. D. Ellis, Dunstone, Yealmpton; s. Free Trade 1301, d. Gentle 4th 3437 by Lo Ben 625.  
1063 III. (£4).—J. SPARROW WROTH, for *Dan Leno* 2111, born Jan. 23, 1904; s. Maasher 769, d. Lorna Doone 2nd 4364 by Old Fashion 633.

**Class 121.—South Devon Cows or Heifers (in-milk), calved before or in 1904.**  
[9 entries, 3 absent.]

- 1066 I. (£10).—BUTLAND BROS., Leigham, Plympton, for *Handsome* 4040, born March 27, 1900, in-milk, calved March 3, 1907, bred by the late B. Butland; s. Cromer 969, d. Beauty 1st 1000 by Melton.  
1067 II. (£6).—BEN LUSCOMBE, South Langstone, Aveton-Gifford, for *Queenie* 2nd 4165, born Nov. 20, 1900, in-milk, calved Oct. 23, 1906; s. General Buller 631, d. Queenie 3199 by Major 2nd 629.  
1070 III. (£4).—W. P. VOSPER, Merafield, Plympton, for *Orange Girl* 6249, born March 8, 1904, in-milk, calved April 29, 1907; s. Drummer 975, d. Cowalip 4th 3923 by Prince Edward 517.  
1069 R. N. & H. C.—W. P. VOSPER, for *Laura*.

**Class 122.—Milk Yield Prizes, open to South Devon Cows and Heifers entered in Class 121 only.** [3 entries, 1 absent.]

- 1068 I. (£10).—W. P. VOSPER, Merafield, Plympton, for *Honesty* 3rd 3930, born Nov. 7, 1898, in-milk, calved March 5, 1907; s. Prince Edward 517, d. Honesty 2nd 2691 by Duke of Devon 2nd 171.  
1073 II. (£6).—J. SPARROW WROTH, Coombe, Aveton-Gifford, for *Nosegay* 4th 4365, born Jan. 4, 1900, in-milk, calved Feb. 4, 1907; s. Old Fashion 653, d. Nosegay 2nd 2737 by Councillor 163.

<sup>1</sup> Champion Prize of £10 10s. given by the Devon Cattle Breeders' Society for the best Cow or Heifer in Class 118 and 119.

<sup>2</sup> The sum of £8 was given by the South Devon Herd Book Society towards these Prizes.

[Unless otherwise stated, each prize animal named below was "bred by exhibitor."]

### Sussex.<sup>1</sup>

**Class 123.—Sussex Bulls, calved in 1902, 1903, or 1904.**

[3 entries, 1 absent.]

- 1975 I. (£15. & Champion.<sup>2</sup>)—E. E. BRABY, Drungewick Manor House, Rudgwick, for Lord of Drungewick 5th 2032, born Jan. 6, 1894; s. Duke of Drungewick 3rd, 1898, d. Ladysmith 7957 by Prince of Drungewick 1530.  
 1976 II. (£10.)—C. J. LUGAS, Warnham Court, Horsham, for Lord Eric 1990, born March 10, 1903; s. Alfred 1637, d. Aldon Prebble A 6056 by Red Hill Goldust 927.

**Class 124.—Sussex Bulls, calved in 1905.** [5 entries, none absent.]

- 1081 I. (£15. & R. N. for Champion.<sup>2</sup>)—PHILIP SAILLARD, Buchan Hill, Crawley, for Bewbush Duke 2179, born June 7; s. Bewbush Marquis 1720, d. Kitty 6645 by Silversmith 2nd 1115.  
 1077 II. (£10.)—E. E. BRABY, Drungewick Manor House, Rudgwick, for Alfred of Drungewick 2110, born Jan. 28; s. Alfred 1637, d. British Beauty 8159 by Drungewick Prebble 1668.  
 1078 III. (£4.)—THE EARL OF DERBY, K.G., Orchardmains, Tonbridge, for Cannon 2321, born April 13; s. Huntsman 1747, d. Cottonasta 7310 by Drungewick 5th 1363.  
 1079 R. N. & H. C.—W. G. FLADGATE, Thakeham, Pulborough, for Apsley Liberty.

**Class 125.—Sussex Bulls, calved in 1906.** [8 entries, 3 absent.]

- 1067 I. (£15.)—THE HON. R. P. NEVILL, Birling Manor, West Malling, for Birling Prince 2265, born Jan. 25; s. Bonfire Prince 2nd 1975, d. Gillyflower 2nd 8171 by Lord Oxeys of Northlands 1406.  
 1066 II. (£10.)—A. J. HICKMAN, Court Lodge, Egerton, Kent, for Sammy 2242, born April 10; s. Lochinvar 2058, d. Shy Lass 8934 by Vicar 1772.  
 1069 III. (£4.)—EARL WINTERTON, Shillinglee Park, Petworth, for Shillinglee Bewbush 4th 2297, born May 2; s. Bewbush 1943, d. Silver 9th 8682 by Brantridge Duke 1408.  
 1065 R. N. & H. C.—THE EARL OF DERBY, K.G., for Guardian.

**Class 126.—Sussex Cows or Heifers (in-milk), calved before or in 1904.**

[5 entries, none absent.]

- 1094 I. (£15. & Champion.<sup>2</sup>)—EARL WINTERTON, Shillinglee Park, Petworth, for Sunlight 7th 9829, born Feb. 1, 1904, calved Jan. 2, 1907; s. Bewbush 1943, d. Sunlight 3rd 8127 by Brantridge Duke 1406.  
 1090 II. (£10.)—THE EARL OF DERBY, K.G., Orchardmains, Tonbridge, for Buttermaid 9185, born June 23, 1903, in-milk, calved Jan. 21, 1907; s. Huntsman 1747, d. Buxom Maid 7916 by Merchant 1485.  
 1091 III. (£4.)—W. F. WINCH, Tiltsden, Cranbrook, for Careless 90th 9240, born Aug. 14, 1903, in-milk, calved Feb. 20, 1907, bred by Col. W. W. Hammond, Nonington, Dover; s. Jayes 1st 1841, d. Careless 54th 7601 by Claude 1677.  
 1093 R. N. & H. C.—EARL WINTERTON, for Sunlight 5th.

**Class 127.—Sussex Heifers, calved in 1905.** [7 entries, 1 absent.]

- 1100 I. (£15. & R. N. for Champion.<sup>2</sup>)—W. F. WINCH, Tiltsden, Cranbrook, for Tiltsden Jessie 10533, born March 1; s. Ensign 1584, d. Jarric 5279 by Ruby 2nd 721.  
 1099 II. (£10.)—W. F. WINCH, for Tiltsden Crumple 10537, born June 2; s. Field Marshal 1882, d. Warden Crumple 7977 by Chatham 1508.  
 1101 III. (£4.)—EARL WINTERTON, Shillinglee Park, Petworth, for Speculation 9th 10645, born Jan. 4; s. Tutsham Gold 1946, d. Speculation 2nd 6385 by Saturn 1043.  
 1095 R. N. & H. C.—THE EARL OF DERBY, K.G., Orchardmains, Tonbridge, for Display.

**Class 128.—Sussex Heifers, calved in 1906.** [13 entries, 4 absent.]

- 1102 I. (£15.)—JOHN AUNGIER, Lynwick, Rudgwick, for Lynwick Beauty 5th 10611, born Jan. 1; s. Sussex 1817, d. Lynwick Beauty 8394 by Drungewick Prebble 1666.  
 1109 II. (£10.)—THE EARL OF DERBY, K.G., Orchardmains, Tonbridge, for Brace-line 10707, born Jan. 8; s. Dragon 1881, d. Buttermaid 9185 by Huntsman 1747.  
 1104 III. (£4.)—JOHN AUNGIER, for Lynwick Primrose 10622, born Jan. 2; s. Paley Major 2059, d. Tutsham Dulcimer 7th 9414 by Freshface 1682.  
 1111 R. N. & H. C.—W. G. FLADGATE, Apsley, Thakeham, Pulborough, for Apsley Fairy.

<sup>1</sup> The sum of £54 was given by the Sussex Herd Book Society towards these Prizes.

<sup>2</sup> Silver Medal given by the Sussex Herd Book Society for the best Bull in Classes 123-125.

<sup>3</sup> Silver Medal given by the Sussex Herd Book Society for the best Cow or Heifer in Classes 126-128.

## lxxviii Award of Live Stock Prizes at Lincoln, 1907.

[Unless otherwise stated, each prize animal named below was "bred by exhibitor."]

### Welsh.

**Class 129.—Welsh Bulls, calved on or after December 1, 1901, and before December 1, 1906.** [5 entries, none absent.]

- 1115 I. (£10, & Special.<sup>1</sup>)—DAVIES, THOMAS & HOWELLS, Mydrim, St. Clears, for Duke of Connaught 248, born Oct. 20, 1902, bred by J. C. Yorke, Treown, Langton, Pembrokeshire; s. Duke of York 247, d. Daisy 894.  
1117 II. (£6.)—LORD HARLECH, Brogntyn, Oŵestry, for Tybor 211, born July 28, 1904, bred by W. E. Oakeley, The Plas, Tan-y-bwch; s. Llymgwyn Bob 106, d. Mafed 1344 S.W.  
1119 III. (£4.)—THE HON. F. G. WYNN, Glynllivon Park, Carnarvon, for The Shah 204, born June 6, 1902, bred by W. E. Oakeley, The Plas, Tan-y-bwch; s. Leporello 621 N.W., d. Mair 4th 909 N.W. by Latimer 188 N.W.  
1116 E. N. & H. C.—R. M. GREAVES, Wern, Portmadoc, for Wern Dividend.

**Class 130.—Welsh Cows or Heifers (in-milk), calved before December 1, 1904.** [2 entries.]

- 1120 I. (£10.)—R. M. GREAVES, Wern, Portmadoc, for Gelliwan 5th 518, born Oct. 7, 1903, in-milk, calved Oct. 25, 1906, bred by T. Roberts, Tanyfynwent, Aber, Bangor; s. Gellifan 153, d. Gelliwan 510 by Dei 447.  
1121 II. (£8.)—THE UNIVERSITY COLLEGE OF NORTH WALES, Madryn, Aber, Bangor, for Madryn Princess, born March 15, 1899, in-milk, calved Dec. 10, 1906, bred by I. Ll. Davies, Derimoilon, Golden Grove; s. Egwad, d. Cornfelin.

**Class 131.—Welsh Heifers, calved on or after December 1, 1904, and before December 1, 1906.** [3 entries.]

- 1123 I. (£10.)—THE UNIVERSITY COLLEGE OF NORTH WALES, Madryn, Aber, Bangor, for Madryn Sally 2nd, born Feb. 12, 1905; s. Madryn Duke 182, d. Madryn Sally 506 by Black Bear 390 N.W.  
1122 II. (£6.)—THE UNIVERSITY COLLEGE OF NORTH WALES, for Madryn Maud, born Jan. 10, 1905; s. Madryn Duke 182, d. Queen.  
1124 III. (£4.)—THE HON. F. G. WYNN, Glynllivon Park, Carnarvon, for Lady Glyn, born Jan. 7, 1905; s. The Shah 204, d. Glyn Bloden 685 by Rhaiadr Du 3rd 455 N.W.

### Red Polled.<sup>2</sup>

**Class 132.—Red Polled Bulls, calved in 1902, 1903, or 1904.**

[5 entries, none absent.]

- 1128 I. (£10, & Champion.<sup>3</sup>)—THE RT. HON. A. E. FELLOWES, Honingham Hall, Norwich, for Alake 9438, born June 28, 1904; s. Advocate 9098, d. Ada 13113 by The Pope, 1128 II. (£6, & E. N. for Champion.<sup>3</sup>)—SIR RICHARD COOPER, BT., Ashlyns Hall, Berkhamsted, for Ashlyns Major 9192, born Jan. 4, 1903; s. Lord Rosebery 8383, d. Wilby 2nd 10893 by Game Boy 2316.  
1127 III. (£4.)—LORD CRANWORTH, Letton, Shipdham, Norfolk, for Davyson 265th 9230, born Aug. 1, 1903, bred by J. Hammond, Bale, East Dereham; s. Majiolini 3600, d. Davy 228th 17993 by Caistor Beaufleur 4782.  
1125 E. N. & H. C.—SIR RICHARD COOPER, BT., for Ashlyns Ben.

**Class 133.—Red Polled Bulls, calved in 1905.** [6 entries, 1 absent.]

- 1131 I. (£10.)—SIR WALTER CORBET, BT., Acton Reynold, Shrewsbury, for Acton Dewstone 9524, born Nov. 26; s. Albert 7783, d. Acton Dewdrop 18977 by Lord Rattler 8977.  
1130 II. (£8.)—SIR RICHARD COOPER, BT., Ashlyns Hall, Berkhamsted, for Ashlyns Duke 9528, born May 20; s. Royal Standard 8707, d. Flaxmoor Orange Girl 18042 by Red Duke 8623.  
1133 III. (£4.)—A. CARLYLE SMITH, Ashmoor, Campsea Ash, Wickham Market, for Ashmoor Mainstay, born May 25, bred by A. J. Smith, Rendlesham, Woodbridge; s. Rendlesham Sirdar 9310, d. Rendlesham Pear Main 17520 by Comely Roger 3856.  
1134 E. N. & H. C.—G. D. SMITH, Strensham Court, Worcester, for Strensham Red Foam.

**Class 134.—Red Polled Bulls, calved in 1906.** [7 entries, 2 absent.]

- 1139 I. (£10.)—THE MARCHIONESS OF GRAHAM, Easton Park, Wickham Market, for Lionel 9711, born Jan. 13, bred by R. Harvey Mason, Necton Hall, Swaffham; s. Rendlesham Wonder 9156, d. Lightsome 18708 by Magician 5021.

<sup>1</sup> Special Prize of £5 5s. given by the Welsh Black Cattle Society for the best Bull in Class 129.

<sup>2</sup> The sum of £20 was given by the Red Polled Society towards these Prizes.

<sup>3</sup> Champion Prize of £5 5s. given by the Red Polled Society for the best Bull in Classes 132-134.

*Red Polled and Aberdeen Angus Cattle.*      **lxxix**

- [Unless otherwise stated, each prize animal named below was "bred by exhibitor."]
- 1141 II. (£8.)—A. J. SMITH, Rendlesham, Woodbridge, for Rendlesham Petrol, born May 30; s. Rendlesham Rosicrucian 9483, d. Rendlesham Pet 14146 by Sweet Lad.
- 1157 III. (£4.)—J. B. DIMMOCK, Shottford Hall, Harleston, for Shottford Dandy, born Feb. 13; s. Nelson 7404, d. Troston Mimic 11900 by Dandy 1768.
- 1136 E. N. & H. C.—SIR WALTER CORBET, BT., for Acton Ajax.
- Class 135.—Red Polled Cows or Heifers (in-milk), calved before or in 1904.**  
[13 entries, 3 absent.]
- 1146 I. (£10, & R. N. for Champion.<sup>1</sup>)—SIR WALTER CORBET, BT., Acton Reynold, Shrewsbury, for Waxlight 2nd 18965, born Feb. 26, 1902, in-milk, calved Jan. 21, 1907, bred by Lord Amherst of Hackney, Diddington Hall, Norfolk; s. Royal Standard 8707, d. Wax Doll 2nd 9068 by Red Shirt 2014.
- 1143 II. (£6.)—THOMAS BROWN & SON, Marham Hall, Downham Market, for Frill 18061, born Oct. 8, 1901, in-milk, calved March 20, 1907; s. Wentworth 5257, d. Freda 10287 by Erebus 841.
- 1149 III. (£4.)—THE RT. HON. A. E. FELLOWES, Honingham Hall, Norwich, for Alba 18066, born Feb. 8, 1902, in-milk, calved Jan. 24, 1907; s. Arthur 7802, d. Avon 14478 by The Pope 4561.
- 1147 E. N. & H. C.—LORD CRANWORTH, Letton, Shipdham, for Davy 287th.
- Class 136.—Red Polled Heifers, calved in 1905.** [9 entries, 2 absent.]
- 1156 I. (£10.)—THOMAS BROWN & SON, Marham Hall, Downham Market, for Davy 306th 20290, born March 20, bred by John Hammond, Bale, East Dereham; s. Majiolini 3600, d. Davy 111th 7041 by Davysun 42nd 1776.
- 1159 II. (£6.)—SIR WALTER CORBET, BT., Acton Reynold, Shrewsbury, for Acton Cranberry 20179, born Jan. 19; s. Edward 9076, d. Acton Cherry 17878 by Logan 6391.
- 1158 III. (£4.)—SIR WALTER CORBET, BT., for Acton Beryl 20177, born Jan. 16; s. Albert 7789, d. Acton Ruby 14423 by Red Lord 5820.
- 1157 E. N. & H. C.—SIR RICHARD COOPER, BT., for Ashlyns Pitwood.
- Class 137.—Red Polled Heifers, calved in 1906.** [10 entries, 3 absent.]
- 1166 I. (£10, & Champion.<sup>1</sup>)—SIR RICHARD COOPER, BT., Ashlyns Hall, Berkhamsted, for Ashlyns Maid, born March 1; s. Royal Standard 8707, d. Ashlyns Handsome 16132 by Rubelette 5182.
- 1165 II. (£6.)—THOMAS BROWN & SON, Marham Hall, Downham Market, for Plume 2nd, born Jan. 5, bred by Lord Amherst of Hackney, Diddington Hall, Norfolk; s. Robin 9160, d. Plume 19404 by Redvers 6690.
- 1168 III. (£4.)—SIR WALTER CORBET, BT., Acton Reynold, Shrewsbury, for Acton Fuchsia, born Jan. 2; s. Albert 7789, d. Acton Tulip 14424 by Red Lord 5820.
- 1171 E. N. & H. C.—THE MARCHIONESS OF GRAHAM, for Mimosa.
- Class 138.—Milk Yield Prizes, open to Red Polled Cows and Heifers entered in Class 135 only.** [7 entries, 1 absent.]
- 1153 I. (£10.)—LORD ROTHSCHILD, Tring Park, Herts, for Clarissa 13315, born Dec. 1, 1898, in-milk, calved April 27, 1907, bred by Garrett Taylor, Whittingham, Norwich; s. Redmond 5147, d. Chrissy 6246 by Master Falstaff 1233.
- 1145 II. (£6.)—SIR WALTER CORBET, BT., Acton Reynold, Shrewsbury, for Desiree of Johnstown 16483, born Dec. 26, 1900, in-milk, calved April 23, 1907, bred by the late Lord Maurice Fitzgerald, Johnstown Castle, Ireland; s. Starston Ruler 5899, d. Johnstown Gloss 9451 by Conqueror 2251.
- 1154 III. (£4.)—LORD ROTHSCHILD, for Rosway Lady 15794, born March 22, 1899, in-milk, calved March 11, 1907, bred by G. F. McCorquodale, Rosway, Berkhamsted; s. Dairy King 4322, d. Buttercup 6225 by Hornet 1209.
- 1163 E. N. & H. C.—LORD ROTHSCHILD, for Coronet 3rd.

**Aberdeen Angus.**

- Class 139.—Aberdeen Angus Bulls, calved on or after December 1, 1901, and before December 1, 1904.** [6 entries, none absent.]
- 1176 I. (£10, Champion.<sup>2</sup> & R. N. for Champion.<sup>3</sup>)—T. H. BAINBRIDGE, Eshott Hall, Felton, for Idelamere 22038, born Feb. 23, 1903; s. Maramere 18160, d. Ideal 26739 by Mailbag 13637.
- 1177 II. (£6.)—J. S. CLARK, Dundas Castle, South Queensferry, for April Fool of Drumfad 22606, born April 12, 1904, bred by C. Dunbar-Buller, Woburn, Donaghadee; s. Morman Barn, 18974, d. Augusta of Drumfad 29823 by Cutler 13281.
- <sup>1</sup> Champion Prize of £5 5s. given by the Red Polled Society for the best Cow or Heifer in Classes 135-137.
- <sup>2</sup> Gold Medal given by the English Aberdeen Angus Cattle Association for the best Animal of the opposite sex to that of the Animal awarded the Gold Medal of the Polled Cattle Society in Classes 139-144.
- <sup>3</sup> Gold Medal given by the Polled Cattle Society for the best Animal in Classes 139-144.

lxxx *Award of Live Stock Prizes at Lincoln, 1907.*

- [Unless otherwise stated, each prize animal named below was "bred by exhibitor."]
- 1170 III. (£4.)—W. B. GREENFIELD, Haynes Park, Bedford, for *Gay Boy of Danesfield* 21967, born Jan. 10, 1903, bred by R. W. Hudson, Danesfield, Marlow; s. Governor of Abergeldie 14447, d. Danesfield Lass 25612 by Black Prince of Ardingley 11484.
- 1180 R. N. & H. C.—R. C. SWAN, Rockliffe Park, Darlington, for *Protestant*.
- Class 140.—Aberdeen Angus Bulls, calved on or after December 1, 1904, and before December 1, 1905.** [10 entries, none absent.]
- 1186 I. (£10, & R. N. for Champion.<sup>1</sup>)—J. R. FINDLAY, Aberlour House, Aberlour, for *Blizzard* 24175, born Jan. 27, 1906, bred by W. Shaw Adamson, Carsington Castle, Brechin; s. Buskin 20222, d. Benefactress of Careston 34966 by Charcoal 17611.
- 1184 II. (£6.)—J. J. CRIDLAN, Home Farm, Maisemore Park, Gloucester, for *Everwise* 24436, born Jan. 19, 1905; s. Wizard of Maisemore 21465, d. Evergreen 7th 35414 by Eimeo 12450.
- 1181 III. (£4.)—T. H. BAINBRIDGE, Eshott Hall, Felton, for *Gabriel of Eshott* 1st 24502, born April 30, 1905; s. Idelamere 22036, d. Gabrielle 31231 by Baron Kerrera 15161.
- 1183 R. N. & H. C.—J. H. BRIDGES, Langshott, Horley, for *Rubus*.
- Class 141.—Aberdeen Angus Bulls, calved on or after December 1, 1905, and before December 1, 1906.** [8 entries, 1 absent.]
- 1196 I. (£10.)—R. WYLIE HILL, Balthayock, Perth, for *Blota* 26331, born Jan. 11, 1906; s. Enochdhu 21848, d. Ismene 34061 by Mondamin 18240.
- 1191 II. (£6.)—SIR GEORGE A. COOPER, BT, Hursley Park, Winchester, for *Black for Ever of Ballindalloch* 25338, born Dec. 11, 1906, bred by Sir George Macpherson Grant, BT, Ballindalloch Castle; s. Everard of Ballindalloch 21902, d. Blackeen 25599 by Delamere 13906.
- 1198 III. (£4.)—MESSRS. WHITE, Moncur and Guardawell, Inchtara, for *Emu of Moncur* 25542, born March 2, 1906, bred by John White; s. European Baron 20502, d. Eugenie of Moncur 32940 by Actor Grand 14069.
- 1192 R. N. & H. C.—SIR GEORGE A. COOPER, BT, for *Premier of Hursley*.
- Class 142.—Aberdeen Angus Cows or Heifers (in-milk), calved before December 1, 1904.** [11 entries, 2 absent.]
- 1208 I. (£10, & Champion.<sup>2</sup>)—J. ERNEST KERR, Harviestoun Castle, Dollar, for *Juana Erica* 36285, born April 28, 1903, in-milk, calved Feb. 14, 1907, bred by the Dowager Countess of Seafield, Cullen House, Cullen; s. Premier of Finlarig 17059, d. Ettins Erica 27495 by Earl of Findlater 12434.
- 1206 II. (£6.)—R. WYLIE HILL, Balthayock, Perth, for *Bartonia of Glamis* 34063, born April 4, 1902, in-milk, calved April 3, 1907, bred by the Earl of Strathmore, Glamis Castle, Forfarshire; s. Jipsej Baron 13532, d. Busy Bet of Hayston 24910 by Provost 2nd of Powrie 11219.
- 1204 III. (£4.)—G. S. GRANT, Auchorachan, Glenlivet, for *Pride of Spey* 4th 37292, born Dec. 2, 1903, in-milk, calved March 21, 1907, bred by J. B. Findlay, Aberlour; s. Kehevin 17732, d. Pride of Guisachan 41st 18625 by Cash 4568.
- 1199 R. N. & H. C.—T. H. BAINBRIDGE, Eshott Hall, Felton, for *Ellen of Abergeldie*.
- Class 143.—Aberdeen Angus Heifers, calved on or after December 1, 1904, and before December 1, 1905.** [7 entries, none absent.]
- 1213 I. (£10.)—J. R. FINDLAY, Aberlour House, Aberlour, for *Prize* 36913, born Dec. 6, 1904; s. Elaborator of Ballindalloch 21807, d. Pride of Honour 33608 by Performer of Aberlour 17018.
- 1215 II. (£6.)—R. WYLIE HILL, Balthayock, Perth, for *Myrtle of Balthayock* 36131, born Dec. 4, 1904; s. Enochdhu 21848, d. Ismene 34061 by Mondamin 18240.
- 1210 III. (£4.)—T. H. BAINBRIDGE, Eshott Hall, Felton, for *Estrella of Eshott* 36487, born May 2, 1905; s. Idelamere 22036, d. Esterel of Southgate 28136 by Gilderoy 3208.
- 216 R. N. & H. C.—J. ERNEST KERR, Harviestoun Castle, Dollar, for *Ellenora*.
- Class 144.—Aberdeen Angus Heifers, calved on or after December 1, 1905, and before December 1, 1906.** [20 entries, 1 absent.]
- 218 I. (£10.)—THE REV. C. BOLDEN, Preston Bissett, Buckingham, for *Veritas of Preston* 40096, born Dec. 22, 1905; s. Publican of Preston 21178, d. Veracity of Preston 27946 by Cadmus of Preston 14183.
- 217 II. (£6.)—T. H. BAINBRIDGE, Eshott Hall, Felton, for *Ebbtide of Eshott* 36061, born Jan. 5, 1906; s. Examiner of Selaby 19107, d. Ebullition 22990 by Jolly Fellow 5236.
- 213 III. (£4.)—R. C. SWAN, Rockliffe Park, Darlington, for *Frides of Aberdeen* 33rd 4616, born Feb. 11, 1906, bred by John Grant, Knockanbuie, Advie; s. Erosion 21875, d. Pride of Fearn 27454 by Ruston 12965.
- 219 R. N. & H. C.—W. B. GREENFIELD, Haynes Park, Bedford, for *Rhona of Haynes*.

Gold Medal given by the English Aberdeen Angus Cattle Association for the best animal of the opposite sex to that of the Animal awarded the Gold Medal of the Polled Cattle Society in Classes 139-144.

Gold Medal given by the Polled Cattle Society for the best Animal in Classes



[Unless otherwise stated, each prize animal named below was "bred by exhibitor."]

### Galloways.<sup>1</sup>

**Class 145.—Galloway Bulls, calved on or after December 1, 1901, and before December 1, 1905.** [7 entries, 3 absent.]

1237 I. (£10 & Champion.<sup>2</sup>)—JOHN CUNNINGHAM, Tarbreoch, Dalbeattie, for Chancellor of Ballyboley 9010, born May 28, 1903, bred by R. J. Calwell, Ballyboley, Co. Antrim; s. Bondsman 7308, d. Marigold of Castlemilk 14879 by Lowlander 2nd of Tarbreoch 5992.

1236A II. (£8.)—THE COUNTESS OF CARLISLE, Naworth Castle, Carlisle, for Bruce of Naworth 9308 (late Kuroki of Craighouse), born March 3, 1904, bred by W. & D. Wilson, Craighouse, Lockerbie; s. Woodland Prince 8772, d. Tibbie of Tundergarth 16987 by Macdougall of Naworth 6980.

1238 III. (£4.)—JOHN CUNNINGHAM, for Orion 9188, born Dec. 22, 1903, bred by Major J. A. O. Wedderburn Maxwell, Glenlair, Dalbeattie; s. Great Scot 6489, d. Rosy of Tarbreoch 15138 by The Gladiator 4th 6188.

1241 E. H. & H. C.—ROBERT GRAHAM, Auchengassel, for Fiscal Policy of Auchengassel.

**Class 146.—Galloway Bulls, calved on or after December 1, 1905, and before December 1, 1906.** [6 entries, none absent.]

1248 I. (£10, & E. H. for Champion.<sup>3</sup>)—ANDREW MONTGOMERY, Nether Hall, Castle Douglas, for Tarbreoch Edward 9703, born March 26, 1906, bred by John Cunningham, Tarbreoch, Dalbeattie; s. Chancellor 9010, d. Netty 30th of Culmain 16984 by Cedric 4th of Tarbreoch 6466.

1245 II. (£6.)—THOMAS GRAHAM, Marchfield, Dumfries, for Oscar of Drumlanrig 9670, born Jan. 2, 1906, bred by the Duke of Buccleuch, K.G., K.T., Drumlanrig Castle, Thornhill; s. Grandee 8449, d. Pride 28th of Drumlanrig 17371 by Earl of Annandale.

1247 III. (£4.)—ANDREW MONTGOMERY, for Speculation 9759, born March 20, 1906, bred by James Gilchrist, Ewanstone, New Galloway; s. Black Prince 8785, d. Violet of Ewanstone 17070 by Macdougall 4th 6841.

1246 E. H. & H. C.—ANDREW MONTGOMERY, for Captain 4th of Tarbreoch.

**Class 147.—Galloway Cows or Heifers (in-milk), calved before December 1, 1904.** [5 entries, none absent.]

1249 I. (£10, & Champion.<sup>3</sup>)—T. BIGGAR & SONS, Chapelton, Dalbeattie, for Flora Macdonald 16422, born May 22, 1900, in-milk, calved March 23, 1907, bred by the Exors. of the late James Cunningham, Tarbreoch, Dalbeattie; s. Winsome 6707, d. Baroness 2nd of Tarbreoch 14748 by Campfollower 5042.

1252 II. (£6.)—JOHN CUNNINGHAM, Tarbreoch, Dalbeattie, for Netty 32nd of Tarbreoch 17906, born April 14, 1903, in-milk, calved March 4, 1907, bred by W. & R. Clark, Culmain, Dalbeattie; s. Worthy 3rd 7762, d. Netty 30th of Culmain 16984 by Cedric 4th of Tarbreoch 6466.

1250 III. (£4.)—JOHN CUNNINGHAM, for Doris of Kilquhanity 16912, born May 1, 1901, in-milk, calved March 20, 1907, bred by Robert Wilson, Kilquhanity, Dalbeattie; s. Great Scot 6489, d. Dora of Durhamhill 13550 by Campfollower 5042.

1253 E. H. & H. C.—A. H. FOX-BROCKBANK, for Lady Primrose of Castlemilk.

**Class 148.—Galloway Heifers, calved on or after December 1, 1904, and before December 1, 1906.** [7 entries, none absent.]

1258 I. (£10, & E. H. for Champion.<sup>3</sup>)—A. H. FOX-BROCKBANK, The Croft, Kirksanton, Cumberland, for Jasmine of Blackcombe 19369, born Jan. 1, 1905, bred by A. B. Matthews, Newton Stewart; s. Cairnhouse 8784, d. Knockstock's Jessie 16116 by Eric of Little Whittrigg 7233.

1256 II. (£6.)—JOHN CUNNINGHAM, Tarbreoch, Dalbeattie, for Maggie Lauder 5th of Tarbreoch 18829, born Dec. 2, 1904; s. Bondsman 7306, d. Maggie Lauder by Macdougall 4th 6841.

1260 III. (£4.)—ROBERT GRAHAM, Auchengassel, Twynholm, for Heroine of Auchengassel 18869, born March 26, 1905; s. Defiance 8268, d. Emily of Auchengassel 17732 by Gay Stanley 7122.

1254 E. H. & H. C.—THOMAS BIGGAR & SONS, for Maggie 4th of Chapelton.

### Highland.

**Class 149.—Highland Bulls, calved before or in 1904.<sup>4</sup>**

[4 entries, 1 absent.]

1261 I. (£10, & Champion.<sup>5</sup>)—IAN BULLOUGH, Meggernie Castle, Aberfeldy, for Albanach, red, born Sept. 8, 1904, bred by Tom Bullough, Fasnachloich, Argyllshire; s. Laogaire 1716, d. Cairne Riabhach 5891 by Rannoch 2065.

<sup>1</sup> The sum of £8 was given by the Galloway Cattle Society towards these Prizes.  
<sup>2</sup> Champion Prize of £5 5s. given by the Galloway Cattle Society for the best Bull in Classes 145 and 146.

<sup>3</sup> Champion Prize of £5 5s. given by the Galloway Cattle Society for the best Cow or Heifer in Classes 147 and 148.

<sup>4</sup> Prizes given by the Highland Cattle Society of Scotland.

<sup>5</sup> Champion Prize of £10 10s. given by the Highland Cattle Society of Scotland for the best Bull in Classes 149 and 150.

lxxxii *Award of Live Stock Prizes at Lincoln, 1907.*

[Unless otherwise stated, each prize animal named below was "bred by exhibitor.]"

- 1264 II. (£8.)—H. C. STEPHENS, Cholderton, Salisbury, for *Loch Tay 1862*, dun, born Jan. 26, 1901, bred by J. & A. Maclaren, Dall, Perthshire; s. Valentine 5th 1062, d. *Romaig Roessie 456* by *Roessie 456*.
- 1263 III. (£4.)—H. C. STEPHENS, for *Cholderton Royal Stewart*, brindle, born March 20, 1904; s. *Barguilean 1632*, d. *Proisag 1st of Atholl 3645* by *Young Stor 699*.

**Class 150.—Highland Bulls, calved in 1905 or 1906.**  
[6 entries, none absent.]

- 1265 I. (£10, & R. N. for Champion.<sup>1</sup>)—IAN BULLOUGH, Meggernie Castle, Aberfeldy, for *An Saighdear*, brindle, born Jan. 2, 1906, bred by the Trustees of the late John Bullough, Meggernie Castle, Aberfeldy; s. *Lord Clyde 2034*, d. *Oashiann 4th by Jagsair 906*.
- 1266 II. (£6.)—WILLIAM SOPPER, Dunmaglass, Daviot, Inverness, for *Agamemnon*, red, born Jan. 12, 1906; s. *King Alaric 1712*, d. *Aggie of Dunlossit 5166* by *Domhnall na Ardmore 1224*.
- 1270 III. (£4.)—D. A. STEWART, Ensay, Portree, for *An-t-Oigra*, brindle, born Nov. 26, 1906; s. *An Eille Cuinte 1913*, d. *Laochag Bhuidhe 4th of Ensay 6584* by *Rhu-na-Scarbh 1410*.

**Class 151.—Highland Cows or Heifers (in-milk), calved before or in 1904.**  
[4 entries.]

- 1274 I. (£10, & Champion.<sup>2</sup>)—D. A. STEWART, Ensay, Portree, for *Laochag Bhuidhe 4th of Ensay 6584*, yellow, born Jan. 8, 1902, in-milk, calved March 12, 1907; s. *Rhu-na-Scarbh 1410*, d. *Laochag Bhuidhe 1st of Ensay 4289* by *Ceatharnach Bhuidhe 719*.
- 1271 II. (£6.)—WILLIAM SOPPER, Dunmaglass, Daviot, Inverness, for *Madam Luna 5289*, yellow, born Jan. 11, 1900, in-milk, calved Jan. 30, 1907, bred by the late Earl of Southesk, K.T., Kinnaird Castle, Brechin; s. *Laoch 1280*, d. *Luna 2297* by *Iain Challum 667*.
- 1273 III. (£4.)—H. C. STEPHENS, Cholderton, Salisbury, for *Odstock 4th of Cholderton 5882*, brindled, born April 8, 1901, in-milk, calved April 30, 1907; s. *Ceatharnach Bhuidhe 719*, d. *Odstock 2nd of Cholderton 3412* by *Calum Odhar of Atholl 79*.

**Class 152.—Highland Heifers, calved in 1905 or 1906.<sup>3</sup>**  
[5 entries, 2 absent.]

- 1279 I. (£10 & R. N. for Champion.<sup>3</sup>)—D. A. STEWART, Ensay, Portree, for *Shelley*, yellow, born June 11, 1905; s. *An Eille Cuinte 1913*, d. *Shelley Bhuidhe of Ensay 6583* by *Laria Marden 904*.
- 1275 II. (£8.)—WILLIAM SOPPER, Dunmaglass, Daviot, Inverness, for *Lunette*, born Feb. 12, 1906; s. *King Alaric 1712*, d. *Madam Luna 5289* by *Laoich 1260*.
- 1276 III. (£4.)—WILLIAM SOPPER, for *Maud of Dunmaglass 6094*, dun, born May 29, 1905; s. *Calum Ban of Atholl 1203*, d. *Meda Maura 6544* by *Barguilean 1632*.

### Ayrshires.<sup>4</sup>

**Class 153.—Ayrshire Bulls, calved in 1902, 1903, 1904, 1905, or 1906.**  
[6 entries, 1 absent.]

- 1282 I. (£10.)—JAMES HOWIE, Hillhouse, Kilmarnock, for *Nether Craig Spicy Sam 5927*, white and brown spots, born Jan. 20, 1904, bred by Robert Forrest, Knockinlaw, Kilmarnock; s. *Not Likely of Hillhouse 4467*, d. *Hareshaw 7th of Orchardton 8324* by *White Bonnet of Orchardton 2023*.
- 1281 II. (£6.)—JAMES HOWIE, for *Howie's Remarkable*, white and little brown, born April 30, 1905, bred by Robert Osborne, Morton Mains, Thornhill; s. *Morton Mains Epicarmus 6793*, d. *Wynholm Auldowrie 15519* by *Gigantic Stunner of Wynholm*.
- 1280 III. (£4.)—JAMES HOWIE, for *Ardgowan Commander*, white and brindle, born Jan. 24, 1906, bred by Sir H. Shaw Stewart, Bart., Ardgowan Castle, Greenock; s. *Howie's Erin-go-Bragh 5348*, d. *Cinderella of Ardgowan 13906* by *Duke of Mauchline*.
- 1283 E. N. & H. C.—ANDREW MITCHELL, Barcheskie, Kirkcudbright, for *Brown Squire*.

**Class 154.—Ayrshire Cows or Heifers (in-milk), calved before or in 1904.**  
[5 entries, none absent.]

- 1289 I. (£10.)—ANDREW MITCHELL, Barcheskie, Kirkcudbright, for *Lady Douglas*, white and brown, born May 25, 1901, in-milk, calved June 1, 1907, bred by James Hamilton, Newhouses, Strathaven; s. *Fairfield Abraham, d. Tosh 1st by Pure Bloom 2529*.
- 288 II. (£8.)—MESSRS. KERR, Old Graitney, Greta, for *Old Graitney Queen 2nd 18250*, red and white, born Sept., 1903, in-milk, calved June 10, 1907; s. *Sir John of Old Graitney 4035*, d. *Queen of Old Graitney* by *Lord Bute of Old Graitney*.

<sup>1</sup> Champion Prize of £10 10s. given by the Highland Cattle Society of Scotland for the best Bull in Classes 149 and 150.

<sup>2</sup> Champion Prize of £10 10s. given by the Highland Cattle Society of Scotland for the best Cow or Heifer in Classes 151 and 152.

<sup>3</sup> Prizes given by the Highland Cattle Society of Scotland.

<sup>4</sup> The sum of £8 was given by the Ayrshire Cattle Herd Book Society towards these prizes.

[Unless otherwise stated, each prize animal named below was "bred by exhibitor."]

1290 III. (£4).—ANDREW MITCHELL, for white and brown, born May 4, 1903, in-milk, calved May 22, 1907, bred by James Mair, Greenhill, Lavington; s. Prince Emerald 4248, d. Minnie by Famous Design 5118.

1290 E. N. & H. C.—JAMES HOWIE, Hillhouse, Kilmarnock, for Lady Flora.

**Class 155.—Milk Yield Prizes, open to Ayrshire Cows and Heifers entered in Class 154 only.** [5 entries, none absent.]

1286 I. (£10).—JAMES HOWIE, Hillhouse, Kilmarnock, for Lady Flora, mottled, born March 14, 1893, in-milk, calved Feb. 14, 1907, bred by Woodburn, Kirkland, Coigtown; s. Roby's Heir of Craighdu 2788, d. Flora.

1287 II. (£6).—JAMES HOWIE, for Nannie 7th of Orchardton 12687, white and little brown, born Feb. 12, 1897, in-milk, calved March 2, 1907, bred by William Gilmour, Orchardton, Cumnock; s. Sonsie's Last of Orchardton 5874, d. Nannie 6th of Orchardton 10080 by Craigs of Kyle of Drumjoan 1793.

1288 III. (£4).—MESSRS. KERR, for Old Graitney Queen 2nd. (See Class 154.)

1290 E. N. & H. C.—ANDREW MITCHELL, Barcheakie, Kirkcudbright, for Lady Douglas.

## Jerseys.

*N.B.—In the Jersey Classes, the number inserted within brackets after the name of an animal indicates the number of such animal in the Island Herd Book. A number without brackets indicates that the animal is registered in the English Jersey Herd Book.*

**Class 156.—Jersey Bulls, calved in 1902, 1903, 1904, or 1905.**

[10 entries, none absent.]

1291 I. (£10).—RHODES H. COBB, The Grove, Esher, for Glorious Lad 7824, whole colour, born March 5, 1902, bred by J. Le Sueur, St. Saviour's, Jersey; s. Foxhill 7208, d. Glorious (7387) P.S.C. by Golden Lad 3324.

1297 II. (£6).—LORD ROTHSCHILD, Tring Park, Herts., for Oxford Wrangler (vol. 17, p. 112), broken colour, born March 8, 1905; s. Oxford Duke 5314, d. Syren 3rd by La Chasse Prince 5243.

1295 III. (£4).—A. MILLER-HALLETT, Goddington, Chelsfield, for Alfriston's Pride, whole colour, born July 19, 1905; s. Goddington Brownie 8526, d. Alfriston Gem by Golden Lad 3324.

1290 E. N. & H. C.—E. DICKSON PARK, Sedgmoor, Loudwater, for St. Amant.

**Class 157.—Jersey Bulls, calved in 1906.** [13 entries, 2 absent.]

1312 I. (£10).—SIR EDWARD STERN, Fan Court, Chertsey, for Cupid, whole colour, born Sept. 4; s. Silken Pop 8710, d. Eros by Golden Duke 7829.

1306 II. (£6).—ARTHUR POCOCK, Freegrove, Calne, for Sheriff, broken colour, born May 18; s. Barrister 8424, d. Lady Everton by Royal Sovereign 7655.

1305 III. (£4).—MRS. C. MCINTOSH, Havering Park, Romford, for La Fosse Hero, fawn, born May 20, bred by W. G. Chavalier, St. John's, Jersey; s. Ashley King (3527), d. La Fosse Beauty (7778).

1304 E. N. & H. C.—JAMES JOICEY, Poulton Priory, Fairfield, for Electrician.

**Class 158.—Jersey Cows (in-milk), calved before or in 1903.**

[21 entries, 3 absent.]

1323 I. (£10).—A. MILLER-HALLETT, Goddington, Chelsfield, for Lady Viola (vol. 17, p. 336), whole colour, born April 28, 1899, in-milk, calved April 28, 1907, bred by J. W. Boutillier, St. Owen's, Jersey; s. Nobleman (2563), d. Bagatelle 2nd by Golden Lad.

1327 II. (£6).—THE EARL OF ROSEBERRY, K.G., Mentmore, Leighton Buzzard, for Lady Rhymer (vol. 17, p. 333), whole colour, born in May, 1902, in-milk, calved April 27, 1907, bred by J. Godeaux, Trinity, Jersey; s. Rhymer 7007.

1330 III. (£4).—LORD ROTHSCHILD, Tring Park, Herts., for Oxford Snowdrop (vol. 17, p. 375), broken colour, born January 27, 1903, in-milk, calved April 27, 1907; s. Oxford Duke 5314, d. Syren 3rd by La Chasse Prince 5243.

1317 E. N. & H. C.—LADY DE ROTHSCHILD, Aston Clinton, Tring, for Whitewood 5th.

**Class 159.—Jersey Heifers (in-milk), calved in 1904.**

[16 entries, 5 absent.]

1335 I. (£10).—RHODES H. COBB, The Grove, Esher, for Golden Fern's Rose 7th, broken colour, born May 16, in-milk, calved May 22, 1907, bred by P. de Gruchy, Trinity, Jersey; s. Moses 3333, d. Golden Fern's Rose 3rd by Galtee More 2504.

1347 II. (£6).—LORD ROTHSCHILD, Tring Park, Herts., for Monista's Lassie, whole colour, born Feb. 22, in-milk, calved May 20, 1907; bred by G. Le Masurier, St. Martin's, Jersey; s. Leda's Golden Lad 7588, d. Monista (8793) F.S.H.C.

1336 III. (£4).—LADY DE ROTHSCHILD, Aston Clinton, Tring, for Doria (vol. 16, p. 104), whole colour, born April 6, in-milk, calved May 14, 1907; s. Flying Foam 7204, d. Dulce of Oaklands.

1344 E. N. & H. C.—ARTHUR POCOCK, Freegrove, Calne, for Black Lily.

## lxxxiv Award of Live Stock Prizes at Lincoln, 1907.

[Unless otherwise stated, each prize animal named below was "bred by exhibitor."]

### Class 160.—*Jersey Heifers (in-milk), calved in 1905.*

[15 entries, 5 absent.]

- 1363 I. (£10).—LORD ROTHSCHILD, Tring Park, Herts, for *Palm Sunday*, whole colour, born April 16, in-milk calved May 14, 1907, bred by J. S. Le Grealey, St. Martin's, Jersey; s. *Admiral Togo* (3561), d. *Mrs. Kruger* (8877).
- 1354 II. (£6).—LADY DE ROTHSCHILD, Aston Clinton, Tring, for *Ghezireh* (Vol. 17, p. 110), whole colour, born April 9, in-milk, calved June 8, 1907; s. *President Boy* 8664, d. *Golden Moos by Drummer* 5885.
- 1362 III. (£4).—A. MILLER-HALLETT, Goddington, Chelsfield, for *Goddington Foxglove*, whole colour, born April 21, in-milk, calved May 14, 1907; s. *Flying Foam* 7204, d. *Meadow Girl* (vol. 12, p. 316) by *Prism* 2383.
- 1356 E. N. & H. C.—FOWLER, DE LA FERRELLE & CO., for *Kanissa's Queenie*.

### Class 161.—*Jersey Heifers, calved in 1906.* [16 entries, 4 absent.]

- 1379 I. (£10).—LORD ROTHSCHILD, Tring Park, Herts, for *Frolic*, whole colour, born April 21; s. *Stratigist* 8720, d. *Frolicsome* 5th by *The Hero* 6892.
- 1378 II. (£6).—ARTHUR POCOCK, Freegrove, Calne, for *Selwood Mary*, whole colour, born Aug. 9, bred by J. W. Steeda, New Close, Frome; s. *Belinda's Boy* 8080, d. *Highland Mary* by *Prince Neddy* 7628.
- 1374 III. (£4).—MRS. C. MCINTOSH, Havering Park, Romford, for *Havering Carnatic* 11th, fawn, born April 17; s. *Jolly Jim* 8564, d. *Carnatic 8th* by *Halburton Prince* 7240.
- 1371 E. N. & H. C.—LADY DE ROTHSCHILD, Aston Clinton, Tring, for *Whitesocks*.

### Class 162.—*Jersey Cows or Heifers (in-milk), bred by Exhibitor, and sired in Great Britain or Ireland, open to Jersey Cows or Heifers entered in Classes 158, 159, and 160 only.* [8 entries, none absent.]

- 1336 I. (£10).—LADY DE ROTHSCHILD, for *Doria*. (See Class 159.)
- 1330 II. (£6).—LORD ROTHSCHILD, for *Oxford Snowdrop*. (See Class 158.)
- 1322 III. (£4).—MRS. C. MCINTOSH, Havering Park, Romford, for *Havering Gloriosa* 5th, fawn, born May 20, 1903, in-milk, calved May 5, 1907; s. *Brompton* 7118, d. *Gloriosa 3rd* (vol. 9, p. 224) by *Silver Grey* 5725.
- 1354 E. N. & H. C.—LADY DE ROTHSCHILD, for *Ghezireh*.

### Class 163.—*Milk Yield Prizes, open to Jersey Cows and Heifers entered in Classes 158, 159 and 160 only.* [9 entries, 1 absent.]

- 1319 I. (£10).—THE LADIES E. & D. HOPE, Great Hollenden, Underriver, Sevenoaks, for *Golden Rush* (vol. 13, p. 286), whole colour, born March 21, 1899, in-milk, calved March 28, 1907, bred by F. Barchard, Horsted, Uckfield; s. *Lord Charles Berestord* 5961, d. *Rush* by *Golden Lad* 3324.
- 1334 II. (£6).—R. BRUCE WARD, Westwood, Droitwich, for *Lucy* (vol. 14, p. 303), whole colour, born July 24, 1900, in-milk, calved Jan. 25, 1907, bred by the Duke of Marlborough, Blenheim; s. *Havering Butterboy* 6264, d. *Lady Polly* by *Golden Hero* 4857.
- 1314 III. (£4).—THOMAS BEEBY, Forest Road, Loughborough, for *Phyllis*, fawn, born Feb. 27, 1898, in-milk, calved Jan. 27, 1907; s. *Oamilla's Hero* 5101, d. *Katherine* (vol. 6, p. 549) by *Halimodendron* 4166.
- 1328 E. N. & H. C.—THE EARL OF ROSEBURY, K.G., for *Welsh Lady*.

## Guernseys.\*

N.B.—Unless otherwise stated, the numbers refer to the *English Guernsey Herd Book*.

### Class 164.—*Guernsey Bulls, calved in 1902, 1903, 1904, or 1905.*

[6 entries, 2 absent.]

- 385 I. (£10).—H. FITZWALTER PLUMPTRE, Goodnestone, Dover, for *Roland of Seaview* 10th 1621, orange, fawn and white, born Aug. 3, 1903, bred by W. A. Glynn, Seaview, Seaview, Isle of Wight; s. *Roland of Seaview* 2nd 1243, d. *Seaview Rose* 3621 by *Billy*.
- 1384 II. (£6).—FRANK HARGREAVES, Merton Grange, Gamlingay, for *Merton Signal* 1601, red and white, born May 20, 1904; s. *Reuben* 2nd 1416, d. *Signalina* 4647 by *Signalman* 585.
- 1382 III. (£4).—E. A. HAMBO, Hayes Place, Hayes, Kent, for *Itchen Royal* 1756, fawn and white, born Feb. 7, 1903, bred by Lady Tichborne, Tichborne Park, Alresford; s. *Golden Secret* 1560, d. *Royal Rose* 4279.
- 1387 E. N. & H. C.—JOHN I. SMAIL, Warren Wood, Hayes, for *Nelson of Warren Wood*.

\* Prizes given by the English Jersey Cattle Society.

The sum of £10 was given by the English Guernsey Cattle Society towards these prizes.

[Unless otherwise stated, each prize animal named below was "bred by exhibitor."]

**Class 165.—Guernsey Bulls, calved in 1906.** [7 entries, none absent.]

1390 I. (£10.)—FRANK HARGREAVES, Merton Grange, Gamlingay, for Royal Governor of the Gron 1889, P.S., R.G.A.S., fawn and white, born March 12, bred by Thomas Bourgaize, Gron. St. Saviour's Guernsey; s. Royal Governor of L'Etiennerie 1848, P.S., R.G.A.S., d. Butter Bowl 3rd 5149, P.S., R.G.A.S.

1394 II. (£6.)—LADY TICHBORNE, Tichborne Park, Alresford, for Moss Raider 1871, red and white, born Aug. 15; s. Itchen Raider 1879, d. Itchen Moss Rose 6186 by Itchen May Day 1473.

1396 III. (£4.)—FRANK HARGREAVES, for Merton Carlo 1858, red and white, born May 11; s. Andover 1635, d. Polly of La Croix 3rd 4607.

1391 R. N. & H. C.—SIR HENRY LENNARD, BT., West Wickham, Kent, for King Cup.

**Class 166.—Guernsey Cows or Heifers (in-milk), calved before or in 1904.**

[15 entries, 5 absent.]

1396 I. (£10.)—E. A. HAMBRO, Hayes Place, Hayes, Kent, for Fi-Fi 5438, fawn and white, born March 11, 1898, in-milk, calved May 19, 1907, bred by T. Simon, Alderney; s. Billy, d. Butter Queen 2nd.

1397 II. (£6.)—FRANK HARGREAVES, Merton Grange, Gamlingay, for Felois 4436, fawn, born July 18, 1897, in-milk, calved April 14, 1907, bred by N. Guilbert, Castel, Guernsey; s. Safeguard of the Capelles 318, G.H.B., d. Myrtle 3867, G.H.B.

1396 III. (£4.)—E. A. HAMBRO, for Express 4432, dark fawn and little white, born March 26, 1895, in-milk, calved May 29, 1907, bred by W. Robin, St. Peter's Port, Guernsey; s. Rydale 4th 865, P.S., R.G.A.S., d. Lively of the Fouilltes 1961, F.S., R.G.A.S.

1396 R. N. & H. C.—FRANK HARGREAVES, for May Paradox 5th.

**Class 167.—Guernsey Heifers, calved in 1905.** [6 entries, 2 absent.]

1412 I. (£10.)—H. FITZWALTER PLUMPTRE, Goodnestone, Dover, for Ranunculus 5th 6676, fawn, born Feb. 15, bred by J. E. Ellis, Wrea Head, Scarborough; s. Broom-flower 1446, d. Ranunculus 4622 by Waldo 2nd 1170.

1414 II. (£6.)—H. C. STEPHENS, Cholderton, Salisbury, for Citron Blossom 25th 6440, fawn and white, born June 8, bred by Mrs. H. C. Stephens; s. Permit 1407, d. Citron Blossom 17th 4385.

1413 III. (£4.)—H. C. STEPHENS, for Cholderton Belle 6430, red and white, born May 24, bred by Mrs. H. C. Stephens; s. Bristol 1547, d. Itchen Belle 5th 6845.

1415 R. N. & H. C.—LADY TICHBORNE, Tichborne Park, Alresford, for Itchen Lily 5th.

**Class 168.—Guernsey Heifers, calved in 1906.** [12 entries, 3 absent.]

1418 I. (£10.)—FRANK HARGREAVES, Merton Grange, Gamlingay, for Clatford Lady Mead 2nd 6813, red and white, born May 10, bred by J. C. Forster, Clatford Mills, Andover; s. Clatford Hope 1647, d. Lady Mead 6212.

1426 II. (£6.)—H. C. STEPHENS, Cholderton, Salisbury, for Claudia's Pride 6818, red and white, born April 24, bred by Mrs. H. C. Stephens; s. Permit 1407, d. Itchen Claudia.

1416 III. (£4.)—E. A. HAMBRO, Hayes Place, Hayes, Kent, for Hayes Golden Cherry 3rd 6900, fawn and white, born July 23; s. Hayes Royal 1674, d. Golden Cherry 5118.

1417 R. N. & H. C.—E. A. HAMBRO, for Hayes Golden Cherry 4th.

**Class 169.—Milk Yield Prizes, open to Guernsey Cows and Heifers entered in Class 166 only.** [6 entries, 1 absent.]

1403 I. (£10.)—H. FITZWALTER PLUMPTRE, Goodnestone, Dover, for Melanie of Goodnestone 2nd 4900, fawn and white, born Sept. 27, 1900, in-milk, calved Jan. 16, 1907; s. Randolph 1152, d. Melanie of Goodnestone 4187 by Signet 2nd 645.

1399 II. (£6.)—SIR HENRY LENNARD, BT., Wickham Court, West Wickham, for Wickham Fancy 6043, red and white, born July 1, 1903, in-milk, calved Jan. 13, 1907, bred by H. Russell, Wood Lodge, West Wickham; s. Wickham Boy 1356, d. Doutra Gallas Fancy 3641, P.S., R.G.A.S.

1406 III. (£4.)—LADY TICHBORNE, Tichborne Park, Alresford, for Itchen Carnation 5846, fawn and white, born Oct. 21, 1903, in-milk, calved March 29, 1907; s. Rival 1343, d. Crystalla 5408 by Royal Squire 4th of L'Etiennerie 1210, P.S., R.G.A.S.

## Longhorns.<sup>1</sup>

**Class 170.—Longhorn Bulls, calved in 1902, 1903, 1904, or 1905.**

[4 entries.]

1430 I. (£10.)—W. L. RILEY, Foleshill Hall, Coventry, for Fradley Conqueror 461, brindle and white, born Sept. 15, 1904, bred by W. S. Shaw, Jun., Fradley Old Hall, Lichfield; s. Wychnor Secundus 401, d. Brindled Beauty by Excelsior 310.

1429 II. (£6.)—T. BASIL P. LEVETT, Wychnor Park, Burton-on-Trent, for Needwood King 468, red and white, born Sept. 1, 1905, bred by Baroness Kinloss, Stowe House, Buckingham; s. Rufus 394, d. Waterloo 11th by Conqueror 7th 302.

<sup>1</sup> The sum of £23 was given by the Longhorn Cattle Society towards these Prizes.

## lxxxvi *Award of Live Stock Prizes at Lincoln, 1907.*

[Unless otherwise stated, each prize animal named below was "bred by exhibitor."]

1431 III. (£4).—W. H. SALE, Arden Hill, Atherstone, for Arden Nobleman 445, brindle and white, born Oct. 28, 1904; s. Young Bow Horn 438, d. Fradley Queen by Romeo 2nd 349.

1428 E. N. & H. C.—LORD GERARD, Eastwell Park, Ashford, for Melcombe Emperor.

**Class 171.**—*Loughorn Bulls, calved in 1906.* [1 entry.]

1432 I. (£10).—LORD GERARD, Eastwell Park, Ashford, Kent, for Eastwell Emperor, dark brindle and white, born March 15; s. Westmeath Squire 435, d. Black-eyed Susan by Kenilworth 317.

**Class 172.**—*Loughorn Cows or Heifers (in-milk), calved before or in 1904.*

[7 entries, 1 absent.]

1437 I. (£10).—W. H. SALE, Arden Hill, Atherstone, for Lady Panza (vol. 4, p. 20), red and white, born Sept. 8, 1902 in-milk, calved May 11, 1907, bred by J. B. Watson, South Mosses, Lamplugh, Cumberland; s. Sancho Panza 395, d. Bow Horn of Upton by Earl of Upton 10th 307.

1435 II. (£6).—LORD GERARD, Eastwell Park, Ashford, for Black-eyed Susan 2nd (vol. 4, p. 13), plum brindle and white, born Jan. 2, 1902 in-milk, calved March 14, 1907, bred by Major H. Jasper Selwyn, Rhyll Manor, Dulverton; s. Wootton Wonder 371, d. Black-eyed Susan by Kenilworth 317.

1436 III. (£4).—C. TOLLEMACHE SCOTT, Bosworth Park, Market Bosworth, for Taverner's Dark Panzy (vol. 2, p. 38), dark brindle, born April 19, 1906, in-milk, calved June 6, 1907, bred by T. Taverner, Upton, by Nuneaton; s. Warwickshire Lad 369.

1438 E. N. & H. C.—C. TOLLEMACHE SCOTT, for Perry 3rd.

**Class 173.**—*Loughorn Heifers, calved in 1905 or 1906.*

[4 entries, none absent.]

1441 I. (£10).—LORD GERARD, Eastwell Park, Ashford, for Grace 11th (vol. 5, p. 40), brindle and white, born Jan. 1, 1905, bred by Baroness Kinlos, Stowe House, Buckingham; s. Rufus 394, d. Grace 7th by Prince Albert 338.

1440 II. (£6).—LORD GERARD, for Empress of Eastwell, red and white, born May 20, 1905; s. Bentley Chieftain 406, d. Woodcote Empress 2nd by Kenilworth 317.

1442 E. N. & H. C.—W. H. SALE, Arden Hill, Atherstone, for Arden Lady.

**Class 174.**—*Milk Field Prizes, open to Loughorn Cows and Heifers entered in Class 172 only.* [2 entries.]

1437 I. (£10).—W. H. SALE, for Lady Panza. (See Class 172.)

1436 II. (£6).—C. TOLLEMACHE SCOTT, for Taverner's Dark Panzy. (See Class 172.)

### Kerries.

*N.B.—In the Kerry Classes, the number inserted within brackets after the name of an animal indicates the number of such animal in the Irish Kerry Herd Book. A number without brackets indicates that the animal is registered in the English Kerry Herd Book.*

**Class 175.**—*Kerry Bulls, calved in 1902, 1903, 1904, or 1905.*

[5 entries, none absent.]

1448 I. (£10, & Champion.<sup>1</sup>)—R. TAIT ROBERTSON, La Mancha, Malahide, Co. Dublin, for La Mancha Diver, born March 27, 1905, bred by Mrs. Madden, Nutley, Bootertown; s. Gort Sheen (475), d. Daisy Colléen (2795).

1446 II. (£6).—LADY GREENALL, Walton Hall, Warrington, for Walton Rajah 153, born March 14, 1904; s. Marquis 3rd of Carton 108, d. Waterville Begum 523.

1445 III. (£4).—SIR CLIFFORD J. CORY, BT., M.P., Llantarnam Abbey, Mon, for Walton Margrave 167, born August 11, 1905, bred by Lady Greenall, Walton Hall, Warrington; s. Marquis 8th of Carton 152, d. Waterville Pearl 2nd 790.

**Class 176.**—*Kerry Cows or Heifers (in-milk), calved before or in 1904.*

[10 entries, 1 absent.]

1452 I. (£10, & E. N. for Champion.<sup>1</sup>)—LADY GREENALL, Walton Hall, Warrington, for Aicme Cold 510, born March 1896, in-milk, calved May 8, 1907, breeder unknown.

1456 II. (£6).—GEORGE LL. PALMER, Lackham, Lacock, Wilts, for Mollig Dhubb 493, born May 25, 1898, in-milk, calved April 16, 1907, bred by the Marquis of Lansdowne, K.G., Bowood, Wilts; s. Sir Cuidh Ruadh (275), d. Colleen Bawn (992) by Shanboe.

1451 III. (£4).—SIR CLIFFORD J. CORY, BT., M.P., Llantarnam Abbey, Mon, for Patricia an Caethramhadh (2337), born April 13, 1896, in-milk, calved April 26, 1907, bred by the Earl of Aberdeen, Aberdeen; s. Desmond (285), d. Patricia an Treas (616) by Curoi (66).

1455 E. N. & H. C.—THE DUCHESS OF NEWCASTLE, for Ivy 7th of Carton.

<sup>1</sup> Challenge Cup, value Twenty-five Guineas, given by the English Kerry and Dexter Cattle Society for the best animal in Classes 175-177, the Cup to become the property of an Exhibitor winning it three years in succession.

[Unless otherwise stated, each prize animal named below was "bred by exhibitor."]

**Class 177.—Kerry Heifers, calved in 1905 or 1906.<sup>1</sup>**

[10 entries, 2 absent.]

- 1459 I. (£10.)—SIR CLIFFORD J. COBY, BT., M.P., Llantarnam Abbey, Mon, for **Llantarnam Lucy**, born April 2, 1905; s. Clonmel Aicme (537), d. Llantarnam Lena (3084) by Finn MacCumbhail (445).  
 1467 II. (£8.)—THOMAS WAITE, Highlands, Redhill, for **Mangerton Aileen**, born 1906, breeder unknown.  
 1468 III. (£4.)—GEORGE LL. PALMER, Lackham, Lacock, Wilts, for **Lackham Rose 849**, born March 20, 1905; s. Shiplake King 132, d. Lady Clonbrooke (2843) by Waterville Knight 53.  
 1461 R. N. & H. C.—LADY GREENALL, Walton Hall, Warrington, for **Walton Can Can**.

**Class 178.—Milk Yield Prizes, open to Kerry Cows and Heifers entered in Class 176 only.** [5 entries, none absent.]

- 1452 I. (£10.)—LADY GREENALL, for **Aicme Cold**. (See Class 176.)  
 1454 II. (£6.)—THE DUCHESS OF NEWCASTLE, Clumber, Worksop, for **Hardwick Pearl 563**, born May 10, 1902, in-milk, calved May 8, 1907; s. Hardwick Prince 69, d. Hardwick Rose by Aicme Carter 59.  
 1456 III. (£4.)—GEORGE LL. PALMER, for **Mollig Dhubb**. (See Class 176.)  
 1457 R. N. & H. C.—EDMUND ROYDS, Caythorpe, Grantham, for **Caythorpe Cockhorn**.

## Dexters.

*N.B.—In the Dexter Classes, the number inserted within brackets after the name of an animal indicates the number of such animal in the Irish Dexter Herd Book. A number within brackets indicates that the animal is registered in the English Dexter Herd Book.*

**Class 179.—Dexter Bulls, calved in 1902, 1903, 1904, or 1905.**

[12 entries, 2 absent.]

- 1469 I. (£10.)—H.M. THE KING, Sandringham, for **King John**, black, born July 7, 1905; s. La Mancha King, d. Waterville Judy.  
 1476 II. (£6.)—THE DUCHESS OF DEVONSHIRE, Compton Place, Eastbourne, for **Compton Dreadnought 673**, black, born Feb. 21, 1903, bred by Mrs. Sheehan, Sneem, Co. Kerry.  
 1473 III. (£4.)—BALDOMERO DE BERTODANO, Cowbridge House, Malmesbury, for **Cowbridge Rufus 290**, red, born Aug. 29, 1905; s. Cowbridge Cock Robin 240, d. La Mancha Snowdrop 871.  
 1477 R. N. & H. C.—H. M. GIBBS, Barrow Court, Bristol, for **Barrow Dan Bahadur**.

**Class 180.—Dexter Cows (in-milk), calved before or in 1903.**

[17 entries, 2 absent.]

- 1487 I. (£10, & Champion.<sup>2</sup>)—THE DUCHESS OF DEVONSHIRE, Compton Place, Eastbourne, for **Compton Daphne 1067**, black, born in 1900, in-milk, calved March 21, 1907, breeder unknown.  
 1485 II. (£8.)—BALDOMERO DE BERTODANO, Cowbridge House, Malmesbury, for **La Mancha Beatrice 62**, red, born March 1898, in-milk, calved Feb. 8, 1907, bred by B. Hayden, Killarney.  
 1483 III. (£4.)—G. J. B. CHETWYND, Wyndthorpe, Doncaster, for **Don Gladiola 1088**, black, born in 1901, in-milk, calved May 9, 1907, breeder unknown.  
 1484 R. N. & H. C.—BALDOMERO DE BERTODANO, for **Cowbridge Sunny Lass**.

**Class 181.—Dexter Heifers (in-milk), calved in 1904.<sup>1</sup>**

[9 entries, none absent.]

- 1505 I. (£10, & R. N. for Champion.<sup>2</sup>)—THE HON. MRS. CLAUD PORTMAN, Goldicote, Stratford-on-Avon, for **La Mancha Hard-to-Find**, red, born April 9, in-milk, calved April 5, 1907, bred by R. Tait Robertson, La Mancha, Malahide; s. La Mancha What Next 279, d. La Mancha Dolly by Daydream 1185.  
 1499 II. (£6.)—BALDOMERO DE BERTODANO, Cowbridge House, Malmesbury, for **Cowbridge Darling 1282**, black, born March, in-milk, calved March 27, 1907, breeder unknown.  
 1502 III. (£4.)—THE DUCHESS OF DEVONSHIRE, Compton Place, Eastbourne, for **Compton Doreen 1439**, black, born March 21, in-milk, calved June 1, 1907, bred by Dr. Boyd, Hillsborough, Co. Down.  
 1504 R. N. & H. C.—H. M. GIBBS, Barrow Court, Bristol, for **Barrow Duchess 2nd**.

<sup>1</sup> Prizes given by the English Kerry and Dexter Cattle Society.

<sup>2</sup> Challenge Cup, value Twenty-five Guineas, given by the English Kerry and Dexter Cattle Society for the best animal in Classes 179-182, the Cup to become the property of an Exhibitor winning it three years in succession.

## lxxxviii Award of Live Stock Prizes at Lincoln, 1907.

[Unless otherwise stated, each prize animal named below was "bred by exhibitor."]

**Class 182.**—*Dexter Heifers, calved in 1905 or 1906.* [14 entries, 1 absent.]

- 1510 I. (£10).—THE DUCHESS OF DEVONSHIRE, Compton Place, Eastbourne, for Compton Diana 675, black, born Feb. 15, 1905, bred by D. O'Malley, Ballybrack.  
1517 II. (£8).—R. TAIT ROBERTSON, La Mancha, Malahide, Co. Dublin, for La Mancha Marjorie, red, born in 1905, breeder unknown.  
1518 III. (£4).—THE COUNTESS OF SEFTON, Croxteth Hall, Liverpool, for Altar Sultana 1208, born April 7, 1905; s. Great Malvern 178, d. Gort Alice.  
1509 R. N. & H. C.—BALDOMERO DE BERTODANO, for Cowbridge Sakura-Rana.

**Class 183.**—*Milk Yield Prizes, open to Dexter Cows and Heifers entered in Classes 180 and 181 only.* [15 entries, 1 absent.]

- 1486 I. (£10).—BALDOMERO DE BERTODANO, Cowbridge House, Malmesbury, for La Mancha Sweet Nell 970, red, born in 1901, in-milk, calved Jan. 25, 1907, breeder unknown.  
1492 II. (£6).—R. TAIT ROBERTSON, La Mancha, Malahide, Co. Dublin, for Aicmo Big (1636), born in 1901, in-milk, calved March 3, 1907, breeder unknown.  
1482 III. (£4).—G. J. B. CHETWYND, Wyndthorpe, Doncaster, for Don Galeandra 1267, black, born in 1901, in-milk, calved May 28, 1907, breeder unknown.  
1488 R. N. & H. C.—THE DUCHESS OF DEVONSHIRE, for Compton Daxia.

### Special Milk Yield Prizes.

**Class 184.**—*Cows (in-milk), of any age, breed, or cross.<sup>1</sup>*  
[36 entries, 3 absent.]

- 888 I. (£20).—JOHN EVENS, for Burton Vic 2nd. (See Class 109.)  
1068 II. (£10).—W. P. VOSPER, for Honesty 3rd. (See Class 122.)  
1526 III. (£5).—JOHN EVENS, for Iris (Shorthorn), red, born 1899, calved June 2, 1907.  
1528 R. N. & H. C.—DUNBAR KELLY, Coombe, Kingston-on-Thames, for Fortuna.

### Butter Tests. [41 entries, 3 absent.]

**Class 185A.**—*Cows, of any age, breed, or cross, exceeding 900 lb., live weight<sup>1</sup>.*

- 1535 I. (£15, G. M.<sup>2</sup>, & S. P. £20.<sup>3</sup>)—THE MARQUIS OF WINCHESTER, Ampot St. Mary's, Andover, for Wench (Jersey) (vol. 13, p. 373), light fawn, born May 6, 1899, calved March 2, 1907, bred by P. Le Couillard, Grouville, Jersey; s. Rook 7011, d. Ladylike 6782 by Fauvett's Boy 4838.  
888 II. (£10, & S. P. £10.<sup>2</sup>)—JOHN EVENS, for Burton Vic 2nd. (See Class 109.)  
1403 III. (£5, & S. P. £5.<sup>2</sup>)—H. F. PLUMPTRE, for Melanie of Goodnestone 2nd. (See Class 169.)  
1899 R. N. & H. C.—SIR HENRY LENNARD, BT, West Wickham, for Wickham Fancy.

**Class 185B.**—*Cows, of any age, breed, or cross, not exceeding 900 lb. live weight.<sup>4</sup>*

- 1531 I. (£15, S. M.<sup>2</sup>, & R. N. for S. P.<sup>2</sup>)—JOSEPH CARSON, Crystalbrook, Theydon Bois, for Mary's Beauty (Jersey) (vol. 15, p. 339), fawn, born Oct. 7, 1900, calved Feb. 8, 1907, bred by Ph. Touzel, St. Lawrence, Jersey; s. Reminder 6384, d. Mary Luke 2nd by Berger 5079.  
1532 II. (£10, & B. M.<sup>2</sup>)—JOSEPH CARSON, for Yosan 9302, F.S.C. (Jersey), fawn grey, born in 1898, calved Jan. 26, 1907, bred by A. Le Sneur, St. Heliers, Jersey.  
1526 III. (£5).—MRS. EYRES MONSELL, Dumbleton Hall, Evesham, for Peace (vol. 17, p. 379), black, born Nov. 13, 1902, in-milk, calved April 8, 1907, bred by G. P. Mead, The Woodlands, Bicton, Shrewsbury; s. King Edward 7557, d. Rose's Pet by Uno 7691.  
1522 R. N. & H. C. (& Certificate.<sup>4</sup>)—GROSVENOR BERRY, for Dewberry.

<sup>1</sup> Prizes given by the English Jersey Cattle Society.

<sup>2</sup> Gold, Silver, and Bronze Medals given by the English Jersey Cattle Society for the three Jersey animals entered or eligible for entry in the English Jersey Herd Book, which obtained the greatest number of points in the Butter Tests.

<sup>3</sup> Special Prizes of £20, £10, and £5, given by the English Jersey Cattle Society for the three Cows in Class 185A and 185B obtaining the greatest number of points in the competition.

<sup>4</sup> Certificate of Merit given by the English Jersey Cattle Society for Jersey cows entered or eligible for entry in the English Jersey Herd Book, not being prize winners.



[Unless otherwise stated, each prize animal named below was "bred by exhibitor."]

## SHEEP.

### Oxford Downs.<sup>1</sup>

**Class 186.**—*Oxford Down Shearling Rams.* [12 entries, none absent.]

- 1539 I. (£10), & 1540 R. N. & H. C.—J. T. HOBBS, Maisey Hampton, Fairford.  
 1542 II. (£5).—JAMES HORLICK, Cowley Manor, Cheltenham.  
 1536 III. (£3).—ALBERT BRASSEY, Heythrop Park, Chipping Norton; s. Heythrop Case 4736.  
 1544 IV. (£2).—HUGH W. STILGOE, The Grounds, Adderbury, Banbury; s. Big Bones 4257, d. by British Standard 3128.

**Class 187.**—*Pens of Three Oxford Down Ram Lambs.* [8 entries, 3 absent.]

- 1549 I. (£10), & 1549 R. N. & H. C.—GEORGE ADAMS, Wadley House, Faringdon.  
 1555 II. (£5).—HUGH W. STILGOE, The Grounds, Adderbury, Banbury; ss. Heythrop 4076 and Royal Reserve.  
 1564 III. (£3).—W. J. P. READING, Rectory Farm, Langford, Lechlade.  
 1553 IV. (£2).—JAMES HORLICK, Cowley Manor, Cheltenham.

**Class 188.**—*Pens of Three Oxford Down Shearling Ewes, of the same Flock.* [6 entries, 1 absent.]

- 1558 I. (£10).—JAMES T. HOBBS, Maisey Hampton, Fairford.  
 1560 II. (£5), & 1561 R. N. & H. C.—JAMES HORLICK, Cowley Manor, Cheltenham.  
 1556 III. (£3), & 1557 IV. (£2).—GEORGE HANKINS, Glebe Farm, Achurch, Oundle.

**Class 189.**—*Pens of Three Oxford Down Ewe Lambs.* [7 entries, 2 absent.]

- 1568 I. (£10).—HUGH W. STILGOE, The Grounds, Adderbury, Banbury; ss. Heythrop 4076 and Royal Reserve.  
 1567 II. (£5).—W. J. P. READING, Rectory Farm, Langford, Lechlade.  
 1562 III. (£3), & 1563 IV. (£2).—GEORGE ADAMS, Wadley House, Faringdon.  
 1566 R. N. & H. C.—JAMES HORLICK, Cowley Manor, Cheltenham.

### Shropshires.

**Class 190.**—*Shropshire Two-Shear Rams.*<sup>2</sup> [9 entries, 3 absent.]

- 1576 I. (£10).—T. S. MINTON, Montford, Shrewsbury.  
 1570 II. (£5).—A. S. BERRY, Shenstone Hall, Lichfield.  
 1574 III. (£3).—SIR RICHARD COOPER, BT., Berkhamsted, for Ashlyns Portsmouth.  
 1572 R. N. & H. C.—FRANK BIBBY, Shrewsbury, for Yankee Reminder.

**Class 191.**—*Shropshire Shearling Rams.* [24 entries, none absent.]

- 1601 I. (£10).—MATTHEW WILLIAMS, Whiston Hall, Albrighton, Wolverhampton.  
 1587 II. (£5), & 1588 R. N. & H. C.—SIR RICHARD COOPER, BT., Berkhamsted.  
 1582 III. (£3).—T. A. BUTTAR, Corston, Coupar Angus.

**Class 192.**—*Pens of Five Shropshire Shearling Rams, of the same Flock.*<sup>2</sup> [15 entries, none absent.]

- 1607 I. (£15).—SIR RICHARD COOPER, BT., Ashlyns Hall, Berkhamsted.  
 1604 II. (£10).—T. A. BUTTAR, Corston, Coupar Angus.  
 1610 III. (£5).—T. S. MINTON, Montford, Shrewsbury.  
 1605 R. N. & H. C.—THE RT. HON. VICTOR CAVENDISH, M.P., Holker Hall, Lancs.

**Class 193.**—*Special Selling (Auction) Shearling Rams.*<sup>2</sup> [12 entries, none absent.]

- 1604 I. (£20), II. (£15), & IV. (£5).—T. A. BUTTAR, Corston, Coupar Angus.  
 1614 III. (£10).—THE DUKE OF SUTHERLAND, K.G., Lilleshall, Newport, Salop.  
 1605 R. N. & H. C.—THE RT. HON. VICTOR CAVENDISH, M.P., Holker Hall, Lancs.

**Class 194.**—*Pens of Three Shropshire Ram Lambs.* [13 entries, 4 absent.]

- 1621 I. (£10).—SIR RICHARD COOPER, BT., Ashlyns Hall, Berkhamsted.  
 1624 II. (£5).—T. S. MINTON, Montford, Shrewsbury.  
 1626 III. (£3).—EDWARD NOCK, Harrington Hall, Shifnal.  
 1623 R. N. & H. C.—MRS. W. F. INGE, Thorpe, Tamworth.

<sup>1</sup> The sum of £8 was given by the Oxford Down Sheep Breeders' Association towards these Prizes.

<sup>2</sup> Prizes given by the Shropshire Sheep Breeders' Association.

xc      *Award of Live Stock Prizes at Lincoln, 1907.*

[Unless otherwise stated, each prize animal named below was "bred by exhibitor."]

**Class 195.**—*Pens of Three Shropshire Shearling Ewes, of the same Flock.*

[6 entries, none absent.]

- 1634 I. (£10), & 1633 R. N. & H. C.—SIR RICHARD COOPER, BT., Berkhamsted.  
1632 II. (£5).—THE RT. HON. VICTOR CAVENDISH, M.P., Holker Hall, Lancs.  
1636 III. (£3).—SIR P. ALBERT MUNTZ, BT., M.P., Dunmore, Rugby.

**Class 196.**—*Pens of Three Shropshire Ewe Lambs.*

[10 entries, 3 absent.]

- 1640 I. (£10).—SIR RICHARD COOPER, BT., Ashlyns Hall, Berkhamsted.  
1644 II. (£5).—EDWARD NOCK, Harrington Hall, Shifnal.  
1638 III. (£3).—THE RT. HON. VICTOR CAVENDISH, M.P., Holker Hall, Lancs.  
1643 R. N. & H. C.—T. S. MINTON, Montford, Shrewsbury.

## Southdowns.

**Class 197.**—*Southdown Two-Shear Rams.*<sup>1</sup> [11 entries, 3 absent.]

- 1652 I. (£10, & Champion.<sup>2</sup>)—W. M. CAZALET, Fairlawn, Tonbridge, for Fairlawn.  
1647 II. (£5).—H.M. THE KING, Sandringham.  
1649 III. (£3).—C. R. W. ADEANE, Babraham Hall, Cambridge.  
1656 R. N. & H. C.—SIR THOMAS V. S. GOOCH, BT., Benacre Hall, Wrentham, for Quidnunc.

**Class 198.**—*Southdown Shearling Rams.* [20 entries, 4 absent.]

- 1665 I. (£10, & R. N. for Champion.<sup>2</sup>)—SIR JEREMIAH COLMAN, BT., Gatton Park.  
1658 II. (£5).—H.M. THE KING, Sandringham.  
1669 III. (£3).—THE EXORS. OF THE LATE COL. H. MCCALMONT, Cheveley, Newmarket.  
1660 R. N. & H. C.—C. R. W. ADEANE, Babraham Hall, Cambridge.

**Class 199.**—*Pens of Three Southdown Shearling Rams, of the same Flock.*<sup>1</sup>

[9 entries, 2 absent.]

- 1684 I. (£10).—THE EXORS. OF THE LATE COL. H. MCCALMONT, Cheveley, Newmarket.  
1679 II. (£5), & 1680 R. N. & H. C.—C. R. W. ADEANE, Babraham Hall, Cambridge.  
1682 III. (£3).—SIR JEREMIAH COLMAN, BT., Gatton Park.

**Class 200.**—*Pens of Three Southdown Ram Lambs.* [10 entries, 3 absent.]

- 1682 I. (£10).—THE DUKE OF DEVONSHIRE, K.G., Compton Place, Eastbourne.  
1687 II. (£5).—H.M. THE KING, Sandringham.  
1694 III. (£3).—THE EXORS. OF THE LATE COL. H. MCCALMONT, Cheveley, Newmarket.  
1690 R. N. & H. C.—W. M. CAZALET, Fairlawn, Tonbridge.

**Class 201.**—*Pens of Three Southdown Shearling Ewes, of the same Flock.*

[9 entries, none absent.]

- 1700 I. (£10, & Champion.<sup>3</sup>)—SIR JEREMIAH COLMAN, BT., Gatton Park.  
1701 II. (£5, & R. N. for Champion.<sup>3</sup>)—THE DUKE OF DEVONSHIRE, K.G., Compton Place, Eastbourne.  
1697 III. (£3).—H.M. THE KING, Sandringham.  
1705 R. N. & H. C.—SIR JULIUS WERNHER, BT., Luton Hoo, Luton.

**Class 202.**—*Pens of Three Southdown Ewe Lambs.* [10 entries, 2 absent.]

- 1706 I. (£10).—H.M. THE KING, Sandringham.  
1714 II. (£5).—THE DUKE OF NORTHUMBERLAND, K.G., Albury Park, Guildford.  
1711 III. (£3).—THE DUKE OF DEVONSHIRE, K.G., Compton Place, Eastbourne.  
1713 R. N. & H. C.—THE EXORS. OF THE LATE COL. H. MCCALMONT, Newmarket.

## Hampshire Downs.

**Class 203.**—*Hampshire Down Two-Shear Rams.*<sup>4</sup> [11 entries, 2 absent.]

- 721 I. (£10), & 1.22 III. (£3).—JAMES FLOWER, Chilmark, Salisbury.  
717 II. (£5).—T. FOWELL BUXTON, Waters Place, Ware, Herts.  
716 R. N. & H. C.—THE HON. D. P. BOUVERIE, Colehill House, Highworth, for Colehill Chilmark.

Prizes given by the Southdown Sheep Society.

<sup>1</sup> Champion Gold Medal, value £10 10s., given by the Southdown Sheep Society for the best Ram in Classes 197 and 198

<sup>2</sup> Silver Medal given by the Southdown Sheep Society for the best pen of Ewes or Ewe Lambs in Classes 201 and 202.

Prizes given by the Hampshire Down Sheep Breeders' Association.

## Southdown, Hampshire Down, and Suffolk Sheep. x

[Unless otherwise stated, each prize animal named below was "bred by exhibitor."

**Class 204.**—*Hampshire Down Shearling Rams.* [16 entries, none absent.]

1738 I. (£10.) & 1737 III. (£3.)—JAMES FLOWER, Chilmark, Salisbury.

1742 II. (£5.)—H. C. STEPHENS, Cholderton, Salisbury.

1730 R. N. & H. C.—T. FOWELL BUXTON, Waters Place, Ware.

**Class 205.**—*Pens of Three Hampshire Down Ram Lambs.*

[15 entries, none absent.]

1747 I. (£10.) & R. N. for Champion.<sup>1</sup>—JAMES FLOWER, Chilmark, Salisbury.

1744 II. (£5.)—T. FOWELL BUXTON, Waters Place, Ware.

17 6 III. (£3.)—THE MARQUIS OF WINCHESTER, Ampott St. Mary's, Andover.

1755 R. N. & H. C.—H. C. STEPHENS, Cholderton, Salisbury.

**Class 206.**—*Pens of Three Hampshire Down Shearling Ewes, of the same Flow*

[3 entries.]

175 1 I. (£10.) & 176 1 II. (£5.)—SIR WILLIAM G. PEARCE, BT., Chilton Lodge, Hungerfo

1758 III. (£3.)—SIR ALEXANDER HENDERSON, BT., Buscot Park, Faringdon.

**Class 207.**—*Pens of Three Hampshire Down Ewe Lambs.*

[10 entries, none absent.]

1764 I. (£10.) & Champion.<sup>1</sup>—JAMES FLOWER, Chilmark, Salisbury.

1762 II. (£5.)—T. FOWELL BUXTON, Waters Place, Ware.

177 1 III. (£3.)—H. C. STEPHENS, Cholderton, Salisbury.

1768 R. N. & H. C.—SIR WILLIAM G. PEARCE, BT., Chilton Lodge, Hungerford.

## Suffolks.

**Class 208.**—*Suffolk Two-Shear Rams.*<sup>2</sup> [5 entries, none absent.]

1775 I. (£10.) & 1774 II. (£5.)—HERBERT E. SMITH, The Grange, Walton, Suffolk.

1773 III. (£3.)—S. R. SHERWOOD, Playford, Ipswich, for Playford Colonel 9322, bred Col. J. E. Groom, Stiffkey, Wells; s. Rediscovery 9320.

1771 R. N. & H. C.—ROBERT BARCLAY, Higham, Bury St. Edmunds, for Higham No.

**Class 209.**—*Suffolk Shearling Rams.* [8 entries, none absent.]

1782 I. (£10.) & 1783 II. (£5.)—HERBERT E. SMITH, The Grange, Walton, Suffolk.

1778 III. (£3.)—D. A. GREEN, Fingringhoe Hall, Colchester, for Fingringhoe Hero; bred by S. Wallace, Hitchin; s. Hitchin Hero 9227.

1780 R. N. & H. C.—S. R. SHERWOOD, Playford, Ipswich.

**Class 210.**—*Suffolk Ram Lambs.*<sup>2</sup> [9 entries, none absent.]

1791 I. (£10.) & 1792 II. (£5.)—HERBERT E. SMITH, The Grange, Walton, Suffolk.

1787 III. (£3.)—D. A. GREEN, Fingringhoe Hall, Colchester.

1790 R. N. & H. C.—S. R. SHERWOOD, Playford, Ipswich.

**Class 211.**—*Pens of Three Suffolk Ram Lambs.* [7 entries, none absent.]

1799 I. (£10.)—HERBERT E. SMITH, The Grange, Walton, Suffolk.

1798 II. (£5.)—S. R. SHERWOOD, Playford, Ipswich.

1796 III. (£3.)—D. A. GREEN, Fingringhoe Hall, Colchester.

1795 R. N. & H. C.—THOMAS GOODCHILD, Great Yeldham Hall, Castle Hedingham.

**Class 212.**—*Pens of Three Suffolk Shearling Ewes, of the same Flock.*

[3 entries.]

1801 I. (£10.) & 1800 II. (£5.)—ROBERT BARCLAY, Higham, Bury St. Edmunds.

1802 III. (£3.)—THOMAS GOODCHILD, Great Yeldham Hall, Castle Hedingham.

**Class 213.**—*Pens of Three Suffolk Ewe Lambs.* [7 entries, none absent.]

1809 I. (£10.)—HERBERT E. SMITH, The Grange, Walton, Suffolk.

1808 II. (£5.)—D. A. GREEN, Fingringhoe Hall, Colchester.

1806 III. (£3.)—S. R. SHERWOOD, Playford, Ipswich.

1805 R. N. & H. C.—THOMAS GOODCHILD, Great Yeldham Hall, Castle Hedingham.

## Dorset Horn.

**Class 214.**—*Dorset Horn Shearling Rams, dropped after November 1, 1901*

[5 entries, 1 absent.]

1812 I. (£10.)—E. A. HAMBRO, Delcombe Farm, Milton Abbey, Blandford, for Delo No. 24 1871; s. Delcombe No. 20 1803.

1811 II. (£5.)—W. R. FLOWER, West Stafford, Dorchester, for Flower's No. 160 1; s. Romulus 1635, d. by Nynehead No. 10 1202.

<sup>1</sup> Champion Prize of £10 given by the Hampshire Down Sheep Breeders' Association for the best Pen of Ram Lambs or Ewe Lambs in Classes 205 and 207.

<sup>2</sup> Prizes given by the Suffolk Sheep Society.

xcii *Award of Live Stock Prizes at Lincoln, 1907.*

[Unless otherwise stated, each prize animal named below was "bred by exhibitor."]

1810 III. (£3.)—JAMES ATTRILL, Waytes Court, Brighstone, Isle of Wight, for Court No. 59 1893; s. Court No. 19 1594.

1814 R. N. & H. C.—FRANK J. MERSON, Farringdon, North Petherton, Bridgwater.

Class 215.—*Pens of Three Dorset Horn Ram Lambs, dropped after November 1, 1906.* [4 entries.]

1816 I. (£10.)—W. R. FLOWER, West Stafford, Dorchester, for Flower's Nos. 161, 162, and 163; s. Petherton Lad 1798, d. by Nynehead No. 10 1202.

1816 II. (£5.)—JAMES ATTRILL, Waytes Court, Brighstone, Isle of Wight.

1817 III. (£3.)—E. A. HAMBRO, Delcombe Farm, Milton Abbey, Blandford; s. Delcombe No. 24 1871.

1818 R. N. & H. C.—FRANK J. MERSON, Farringdon, North Petherton, Bridgwater.

Class 216.—*Pens of Three Dorset Horn Shearling Ewes, of the same Flock, dropped after November 1, 1905.* [5 entries, 1 absent.]

1821 I. (£10), & 1822 R. N. & H. C.—E. A. HAMBRO, Delcombe Farm, Milton Abbey, Blandford; s. Delcombe No. 20 1803.

1823 II. (£5.)—FRANK J. MERSON, Farringdon, North Petherton, Bridgwater; s. Toulton No. 11 1351, d. by One Horn 1468.

1819 III. (£3.)—W. R. FLOWER, West Stafford, Dorchester; s. Petherton Lad 1798, d. by Nynehead No. 10 1202.

Class 217.—*Pens of Three Dorset Horn Ewe Lambs, dropped after November 1, 1906.*<sup>1</sup> [7 entries, none absent.]

1828 I. (£10), & 1829 R. N. & H. C.—E. A. HAMBRO, Delcombe Farm, Milton Abbey, Blandford; s. Delcombe No. 24 1871.

1825 II. (£5.)—JAMES ATTRILL, Waytes Court, Brighstone, Isle of Wight.

1827 III. (£3.)—W. R. FLOWER, West Stafford, Dorchester; s. Petherton Lad 1798, d. by Nynehead No. 10 1202.

## Ryeland.

Class 218.—*Ryeland Rams, Two-shear and upwards.*<sup>2</sup> [4 entries.]

1834 I. (£10.) F. E. GOUGH, The Moor, Bodenham, Leominster, for ram, born March 3, 1905; s. Evesham 74a.

1832 II. (£5.)—W. T. BARNEBY, Saltmarshe Castle, Bromyard, for Twin Star, born March, 1904; s. Linchpin, d. by Bodenham Star.

1831 III. (£3.)—W. T. BARNEBY, for Honeypot, born March, 1905; s. Park Royal, d. by Slowcoach.

1833 R. N. & H. C.—W. H. DAVIES, Claston, Dormington, for Claston.

Class 219.—*Ryeland Shearling Rams.* [3 entries.]

1837 I. (£10.) F. E. GOUGH, The Moor, Bodenham, Leominster; s. Evesham 74a.

1835 II. (£5), & 1836 III. (£3.)—W. T. BARNEBY, Saltmarshe Castle, Bromyard.

Class 220.—*Pens of Three Ryeland Shearling Ewes, of the same Flock.* [4 entries.]

1840 I. (£10.)—W. H. DAVIES, Claston, Dormington, Herefordshire.

1841 II. (£5.)—F. E. GOUGH, The Moor, Bodenham, Leominster; s. Moorland Chief 10.

1838 III. (£3), & 1839 R. N. & H. C.—W. T. BARNEBY, Saltmarshe Castle, Bromyard.

## Kerry Hill.

Class 221.—*Kerry Hill Rams, Two-Shear and Upwards.*

[7 entries, none absent.]

1845 I. (£10.)—LAWTON MOORE, Brampton Brian, for Brampton Faultless 1279, born April 4, 1905; s. Sir Roger 170, d. by Brampton Active 215.

1843 II. (£5.)—JOHN HAMAR, The Farlands, Brampton Brian, for Brampton Envoy 867, born March, 1904, bred by Lawton Moore, Brampton Brian; s. Sir Roger 170.

1846 III. (£3.)—LAWTON MOORE, for Brampton Lengthy 1298, born in 1905, bred by R. B. Williams & Sons, Lower Mellington, Churchstoke, Mont; s. Heyope Lead On 813, d. by Corndon Leader 59.

1844 R. N. & H. C.—LORD HARLECH, Brogyntyn, Oswestry, for Brampton Forester.

Class 222.—*Kerry Hill Shearling Rams.* [4 entries.]

1851 I. (£10.)—LAWTON MOORE, Brampton Brian, for Brampton Grateful; s. Brampton Dictator 733, d. by Brampton Conqueror 716.

1850 II. (£5.)—T. E. KINSEY, Winsbury, Chirbury, for Winsbury Beauty; s. Bahallion Commander 514, d. by Ragdon Record 676.

<sup>1</sup> Prizes given by the Dorset Horn Sheep Breeders' Association.

<sup>2</sup> Prizes given by the Ryeland Flock Book Society.

[Unless otherwise stated, each prize animal named below was "bred by exhibitor."]

1852 III. (£3.)—LAWTON MOORE, for *Weston Challenger*, bred by John Anwyl, Priest Weston, Chirbury; s. Roundabout's Pride 930, d. by Protector 924.

1849 E. N. & H. C.—W. P. & J. M. JAMES, Churchstoke, for *Brompton Model*.

**Class 223.**—*Pens of Three Kerry Hill Shearling Ewes, of the same Flock.* [5 entries, none absent.]

1853 I. (£14.)—JOHN ANWYL, Priest Weston, Chirbury; s. Roundabout's Pride 930, d. by Protector 924.

1856 II. (£5.)—LAWTON MOORE, Brampton Brian; ss. Pentrenant Motto 1493, Gwernybuarth Speckle Face 1353 and Brampton Dictator 733.

1857 III. (£3.)—JOHN & RICHARD PHILLIPS, Llwynybrain, Caersws; s. Marker 1200 d. by Llwynybrain Thumper 126.

1856 E. N. & H. C.—W. P. & J. M. JAMES, Brompton Hall, Churchstoke.

**Class 224.**—*Pens of Three Kerry Hill Ewe Lambs.* [6 entries, none absent.]

1860 I. (£10.)—W. P. & J. M. JAMES, Brompton Hall, Churchstoke; s. Brompton Laird 1286, d. by Traveller 496.

1861 II. (£5.)—T. E. KINSEY, Winsbury, Chirbury; s. Bahaillon Combination 512, d. by Ragdon Record 676.

1858 III. (£3.)—W. BISHOP, Posenhall, Broseley; s. Gwernybuarth Anchor 1353, ds. by Brampton Amendment 228 and Foundation 1071.

1862 E. N. & H. C.—JOHN & RICHARD PHILLIPS, Llwynybrain, Caersws, Mont.

### Lincolns.<sup>1</sup>

**Class 225.**—*Lincoln Two-Shear<sup>2</sup> Rams.* [17 entries, 3 absent.]

1875 I. (£10, & Special<sup>3</sup>)—F. MILLER, La Belen, Clifton Road, Birkenhead, for *Nocton Energy*, bred by R. & W. Wright, Nocton Heath, Lincoln; s. Quarrington Energy.

1870 II. (£5.)—HENRY DUDDING, Riby Grove, Great Grimsby, for ram, bred by F. Ward, Quarrington, Sleaford.

1876 III. (£3.)—F. MILLER, for *Nocton Enterprise*, bred by R. & W. Wright, Nocton Heath, Lincoln; s. Quarrington Energy 8510.

1880 IV. (£2.)—FREDERICK WARD, Quarrington, Sleaford, for *Harlaxton Surprise*, bred by T. S. Pearson-Gregory, Harlaxton, Grantham; s. Quarrington Harlaxton 1st 8011.

1867 E. N. & H. C.—S. E. DEAN & SONS, Dowsby Hall, Bourne, for *Dowsby Rex*.

**Class 226.**—*Lincoln Shearling Rams.* [35 entries, 2 absent.]

1893 I. (£15, & R.N. for Special<sup>2</sup>), & 1894 V. (£4.)—HENRY DUDDING, Riby Grove, Great Grimsby.

1887 II. (£10.)—TOM CASSWELL, Pointon House, Folkingham.

1890 III. (£7.)—S. E. DEAN & SONS, Dowsby Hall, Bourne.

1883 IV. (£5.)—JAMES CARTWRIGHT, Dunston Pillar, Nocton, Lincoln.

1907 VI. (£3.)—JOHN PEARS, Mere, Lincoln.

1904 E. N. & H. C.—GEORGE MARRIS, Kirmington, Brocklesby.

**Class 227.**—*Lincoln Shearling Rams, the property of exhibitors who have never exhibited Lincoln Sheep at any previous Show of the R.A.S.E. Open to animals entered in Class 226 only.* [12 entries, none absent.]

1883 I. (£10.)—JAMES CARTWRIGHT, Dunston Pillar, Nocton, Lincoln.

1912 II. (£5.)—THOMAS SPINK, Hunmanby, Yorks, for *Hunmanby Express*; s. Nocton Express 8410, d. by Hunmanby Rover 4488.

1896 III. (£3.)—CHARLES FEATHERSTONE, The Grange, Nocton, Lincoln.

1906 E. N. & H. C.—FRED MONEY, Silk Willoughby, Sleaford.

**Class 228.**—*Pens of Five Lincoln Shearling Rams, of the same Flock.* [33 entries, 2 absent.]

1830 I. (£30, & Special<sup>3</sup>)—HENRY DUDDING, Riby Grove, Great Grimsby.

1841 II. (£20.)—JOHN PEARS, Mere, Lincoln.

1925 III. (£16.)—TOM CASSWELL, Pointon House, Folkingham.

1926 IV. (£14.)—S. E. DEAN & SONS, Dowsby Hall, Bourne.

1836 V. (£12.)—CHARLES E. HOWARD, Nocton Rise, Lincoln.

1947 VI. (£8.)—FREDERICK WARD, Quarrington, Sleaford.

1822 E. N. & H. C.—JAMES CARTWRIGHT, Dunston Pillar, Nocton, Lincoln.

<sup>1</sup> The sum of £317 was given by the Lincoln Long-wool Sheep Breeders' Association towards these Prizes.

<sup>2</sup> Special Prize of £10 given by the Lincolnshire Agricultural Society, for Members of that Society only, for the best Ram in Classes 225 and 226.

<sup>3</sup> Piece of Plate, value £10 10s., given by the Lincoln Long-wool Sheep Breeders' Association for the best Pen of Shearling Rams in Class 228.

xciv *Award of Live Stock Prizes at Lincoln, 1907.*

[Unless otherwise stated, each prize animal named below was "bred by exhibitor."]

**Class 229.**—*Pens of Five Lincoln Shearling Rams of the same flock, the property of Exhibitors who have never exhibited Lincoln Sheep at any previous Show of the R.A.S.E. Open only to animals entered in Class 228.*  
[19 entries, 1 absent.]

- 1922 I. (£15.)—JAMES CARTWRIGHT, Dunston Pillar, Nocton, Lincoln.  
1919 II. (£10.)—WILLIAM BAYLES, Welton Cliff, Lincoln.  
1920 III. (£5.)—JOSEPH BROCKLEBANK, Carlton-le-Moorland, Newark.  
1927 IV. (£2.)—CHARLES S. DICKINSON, Branston, Lincoln.  
1931 R. N. & H. C.—CHARLES FEATHERSTONE, The Grange, Nocton, Lincoln.

**Class 230.**—*Pens of Three Lincoln Ram Lambs.* [17 entries, 3 absent.]  
1957 I. (£10.) & 1958 R. N. & H. C.—HENRY DUDDING, Riby Grove, Great Grimsby.  
1954 III. (£5.) & 1956 II. (£3.)—S. E. DEAN & SONS, Dowsby Hall, Bourne.  
1962 IV. (£2.)—JOHN PEARS, Mere, Lincoln.

**Class 231.**—*Pens of Three Lincoln Shearling Ewes, of the same Flock.*  
[12 entries, none absent.]

- 1975 I. (£10.)—CHARLES E. HOWARD, Nocton Rise, Lincoln.  
1972 II. (£5.)—HENRY DUDDING, Riby Grove, Great Grimsby.  
1969 III. (£3.) & 1968 IV. (£2.)—S. E. DEAN & SONS, Dowsby Hall, Bourne.  
1967 R. N. & H. C.—TOM CASSWELL, Pointon House, Folkingham.

**Class 232.**—*Pens of Three Lincoln Ewe Lambs.* [12 entries, 4 absent.]  
1983 I. (£10.) & 1982 IV. (£2.)—HENRY DUDDING, Riby Grove, Great Grimsby.  
1979 II. (£5.) & 1980 III. (£3.)—S. E. DEAN & SONS, Dowsby Hall, Bourne.  
1986 R. N. & H. C.—JOHN PEARS, Mere, Lincoln.

**Class 233.**—*Pens of Three Lincoln Yearling Ewes, in Wool.*  
[19 entries, none absent.]

- 2000 I. (£25, & Special<sup>1</sup>) & 2001 II. (£20, & R. N. for Special<sup>1</sup>)—CHARLES E. HOWARD, Nocton Rise, Lincoln.  
1999 III. (£15.)—HENRY DUDDING, Riby Grove, Great Grimsby.  
1994 IV. (£12.)—TOM CASSWELL, Pointon House, Folkingham.  
2006 V. (£10.)—W. B. SWALLOW, Wootton Lawn, Uleceby.  
1993 VI. (£8.)—J. E. CASSWELL, Laughton, Folkingham.  
1996 R. N. & H. C.—S. E. DEAN & SONS, Dowsby Hall, Bourne.

**Class 234.**—*Groups of One Exhibit from not less than Four Classes of Lincoln Sheep.* [7 entries, none absent.]

- E. I. Piece of Plate.—HENRY DUDDING, Riby Grove, Great Grimsby.  
F. II. Piece of Plate.—C. E. HOWARD, Nocton Rise, Lincoln.  
B. R. N. & H. C.—TOM CASSWELL, Pointon House, Folkingham.

## Leicesters.<sup>2</sup>

**Class 235.**—*Leicester Shearling Rams.* [10 entries, 1 absent.]

- 2013 I. (£10.) & 2011 R. N. & H. C.—GEORGE HARRISON, Gainford Hall, Darlington.  
2014 II. (£5.) & 2016 III. (£3.)—E. F. JORDAN, Eastburn, Driffield.

**Class 236.**—*Pens of Three Leicester Ram Lambs.* [6 entries, 1 absent.]

- 2024 I. (£10.)—J. E. & C. H. SIMPSON, Pilmoor House, Hunmanby.  
2020 II. (£5.) & 2019 III. (£3.)—GEORGE HARRISON, Gainford Hall, Darlington.  
2023 R. N. & H. C.—MRS. PERRY-HERRICK, Beau Manor Park, Loughborough.

**Class 237.**—*Pens of Three Leicester Shearling Ewes, of the same Flock.*  
[7 entries, none absent.]

- 2027 I. (£10.) & 2026 III. (£3.)—GEORGE HARRISON, Gainford Hall, Darlington.  
2028 II. (£5.)—E. F. JORDAN, Eastburn, Driffield.  
2025 R. N. & H. C.—JOHN CRANSWICK, Field House, Hunmanby.

**Class 238.**—*Pens of Three Leicester Ewe Lambs.* [6 entries, none absent.]

- 2037 I. (£10.)—J. E. & C. H. SIMPSON, Pilmoor House, Hunmanby.  
2033 II. (£5.)—GEORGE HARRISON, Gainford Hall, Darlington.  
2034 III. (£3.) & 2035 R. N. & H. C.—E. F. JORDAN, Eastburn, Driffield.

<sup>1</sup> Special Prize of £10 given by the Lincolnshire Agricultural Society, for Members of that Society only, for the best Pen of Shearling Ewes, Ewe Lambs, or Yearling Ewes in Classes 231-233.

<sup>2</sup> The sum of £18 was given by the Leicester Sheep Breeders' Association towards these Prizes.

## Various Breeds of Sheep.

xcv

[Unless otherwise stated, each prize animal named below was "bred by exhibitor."]

### Cotswolds.<sup>1</sup>

**Class 239.—Cotswold Shearling Rams.** [4 entries.]

- 2038 I. (£10), & 2039 II. (£5).—W. T. GARNE & SON, Aldsworth, Northleach.  
2040 R. H. & H. C.—WILLIAM HOULTON, Broadfield Farm, Northleach.

**Class 240.—Pens of Three Cotswold Ram Lambs.** [5 entries, 2 absent.]

- 2042 I. (£10), & 2043 R. H. & H. C.—W. T. GARNE & SON, Aldsworth, Northleach.  
2044 II. (£5).—WILLIAM HOULTON, Broadfield Farm, Northleach.

**Class 241.—Pens of Three Cotswold Shearling Ewes, of the same Flock.**  
[3 entries.]

- 2047 I. (£10), & 2048 R. H. & H. C.—W. T. GARNE & SON, Aldsworth, Northleach.  
2049 II. (£5).—WILLIAM HOULTON, Broadfield Farm, Northleach.

**Class 242.—Pens of Three Cotswold Ewe Lambs.** [4 entries, 2 absent.]

- 2050 I. (£10), & 2051 II. (£5).—W. T. GARNE & SON, Aldsworth, Northleach.

### Border Leicesters.<sup>2</sup>

**Class 243.—Border Leicester Rams, Two-Shear and upwards.**

[2 entries.]

- 2055 I. (£10, & Champion.<sup>3</sup>)—ROBERT TAYLOR, Pitlivie, Carnoustie, for Pitlivie Brilliant, born March 14, 1904, bred by the Duke of Buccleuch, K.T., Dalkeith Park, Edinburgh; s. The Brilliant, d. Happy Thought.  
2064 II. (£5).—J. ERNEST KERR, Harviestoun Castle, Dollar, for Fortoun Barrelwell 1568, born March, 1904, bred by David Hume, Barrelwell, Brechin; s. Prime Favourite 1311, d. by Surprise 588.

**Class 244.—Border Leicester Shearling Rams.**

[8 entries, none absent.]

- 2057 I. (£10, & R. H. for Champion.<sup>3</sup>)—DAVID HUME, Barrelwell, Brechin; s. Learton Express 1632, d. by Lucky Lad 670.  
2059 II. (£5).—J. ERNEST KERR, Harviestoun Castle, Dollar; s. Lord Hume 1643, d. by Prince George 1313.  
2063 R. H. & H. C.—DAVID HUME.

**Class 245.—Pens of Three Border Leicester Shearling Ewes, of the same Flock.**

[5 entries, none absent.]

- 2066 I. (£10).—J. ERNEST KERR, Harviestoun Castle, Dollar; s. Lord Hume 1643, ds. by Balquharn Prince 15 and Polwarth Prince 237.  
2067 II. (£5).—ROBERT TAYLOR, Pitlivie, Carnoustie.  
2068 R. H. & H. C.—DAVID HUME, Barrelwell, Brechin.

### Kent or Romney Marsh.<sup>4</sup>

**Class 246.—Kent or Romney Marsh Two-Shear Rams.**

[5 entries, none absent.]

- 2070 I. (£10).—CHARLES FILE, Elham, Canterbury, for Elham No. 70 of 1905 18700; s. Elham No. 60 of 1903 13200, d. No. 65 of 1901 by Window 9th 8060.  
2069 II. (£5).—GEORGE FARMER, Leeds Abbey, Maidstone, for Farmer's No. 10 of 1905; s. Farmer's No. 33 of 1903.  
2073 III. (£3).—J. EGERTON QUESTED, The Firs, Cheriton, Kent.  
2071 R. H. & H. C.—WILLIAM MILLEN, Syndale Valley, Faversham.

**Class 247.—Kent or Romney Marsh Shearling Rams.** [24 entries, 1 absent.]

- 2060 I. (£10), 2061 IV. (£2), & 2082 R. H. & H. C.—CHARLES FILE, Elham, Canterbury.  
2060 II. (£5), & 2069 III. (£3).—J. B. PALMER, New Shelve Manor, Lenham, Maidstone; s. Jumbo 49th 8074.

<sup>1</sup> The sum of £25 was given by the Cotswold Sheep Society towards these Prizes.

<sup>2</sup> The sum of £15 was given by the Society of Border Leicester Sheep Breeders towards these Prizes.

<sup>3</sup> Champion Prize of £5 given by the Society of Border Leicester Sheep Breeders for the best Ram in Classes 243 and 244.

<sup>4</sup> The sum of £25 was given by the Kent or Romney Marsh Sheep Breeders' Association towards these Prizes.

xcvi *Award of Live Stock Prizes at Lincoln, 1907.*

[Unless otherwise stated, each prize animal named below was "bred by exhibitor."]

**Class 248.—Pens of Three Kent or Romney Marsh Ram Lambs.**

[13 entries, none absent.]

- 2104 I. (£10).—WILLIAM MILLEN, Syndale Valley, Faversham.  
 2106 II. (£5).—J. B. PALMER, New Shelve Manor, Lenham, Maidstone.  
 2098 III. (£3).—ALFRED AMOS, Spring Grove Farm, Wye.  
 2108 IV. (£2).—HENRY RIGDEN, Etchinghill, Lyminge, Kent.  
 2100 E. N. & H. C.—EDWARD ASCHERSON, Pett Place, Charing, Kent.

**Class 249.—Pens of Three Kent or Romney Marsh Ewes, of the same Flock.** [9 entries, 1 absent.]

- 2118 I. (£10).—J. B. PALMER, New Shelve Manor, Lenham, Maidstone; s. Macknade Blue Prefer 8th 14727.  
 2114 II. (£5). & 2115 E. N. & H. C.—WILLIAM MILLEN, Syndale Valley, Faversham.  
 2112 III. (£3).—CHARLES FLE, Elham, Canterbury.  
 2119 IV. (£2).—HENRY RIGDEN, Etchinghill, Lyminge, Kent.

**Class 250.—Pens of Three Kent or Romney Marsh Ewe Lambs.**

[8 entries, none absent.]

- 2122 I. (£10).—WILLIAM MILLEN, Syndale Valley, Faversham.  
 2125 II. (£5).—J. EGBERTON QUESTED, The Fir, Cheriton, Kent.  
 2121 III. (£3).—A. J. HICKMAN, Court Lodge, Egerton, Kent.  
 2124 IV. (£2).—J. B. PALMER, New Shelve Manor, Lenham, Maidstone.  
 2126 E. N. & H. C.—HENRY RIGDEN, Etchinghill, Lyminge, Kent.

## Wensleydales.<sup>1</sup>

**Class 251.—Wensleydale Two-Shear Rams.<sup>2</sup>** [3 entries.]

- 2130 I. (£10).—THE EXORS. OF THE LATE THOMAS WILLIS, Manor House, Carperby, Yorks, for Royal Derby; s. Royal Prince 981, d. by Royal York 668.  
 2128 II. (£5).—LORD HENRY BENTINCK, Underley Hall, Kirkby Lonsdale, for King of Blues 1041, bred by Richard Stuart, Brook Vale, Sowerby; s. Creditor 789, d. by Blue Skin 532.  
 2129 E. N. & H. C.—THE EXORS. OF THE LATE THOMAS WILLIS, for Crown Prince 1021.

**Class 252.—Wensleydale Shearling Rams.** [6 entries, 1 absent.]

- 2136 I. (£10).—THE EXORS. OF THE LATE THOMAS WILLIS, Manor House, Carperby bred by John Moore, Yorescott, Askrigg; s. Royal Prince 981, d. by Blue Jack 607.  
 2134 II. (£5).—THE EXORS. OF THE LATE THOMAS WILLIS; s. Crown Prince 1021, d. by Royal London 904.  
 2132 III. (£3).—LORD HENRY BENTINCK, Underley Hall, Kirkby Lonsdale, for Underley Blue; s. Prince of Blue 973, d. by Boy in Blue 472.

**Class 253.—Pens of Three Wensleydale Shearling Ewes, of the same Flock.** [4 entries, none absent.]

- 2139 I. (£10).—THE EXORS. OF THE LATE THOMAS WILLIS, Manor House, Carperby; ss. Crown Prince 1021 and Royal Heir 980.  
 2137 II. (£5).—LORD HENRY BENTINCK, Underley Hall, Kirkby Lonsdale; s. Prince of Blue 973, da. by Top Sawyer 762 and Winder 523.  
 2138 III. (£3).—LORD HENRY BENTINCK; s. Prince of Blue 973, da. by Blue Stone 779, Blue Beard 607, and Royal Manchester 2nd 667.

## Devon Long Wool.<sup>3</sup>

**Class 254.—Deron Long Wool Shearling Rams.** [2 entries.]

- 2141 I. (£10), & 2142 II. (£5).—FREDERICK WHITE, Torweston, Williton, Somerset.

**Class 255.—Pens of Three Devon Long Wool Ram Lambs.** [3 entries.]

- 2144 I. (£10), & 2143 II. (£5).—FREDERICK WHITE, Torweston, Williton, Somerset.

**Class 256.—Pens of Three Devon Long Wool Shearling Ewes, of the same Flock.** [2 entries.]

- 2145 I. (£10), & 2146 II. (£5).—FREDERICK WHITE, Torweston, Williton, Somerset.

<sup>1</sup> The sum of £5 was given by the Wensleydale Sheep Breeders' Association towards the Prizes in Classes 252 and 253.

<sup>2</sup> Prizes given by the Wensleydale Blue-faced Sheep Breeders' Association and Flock Book Society for Rams entered or eligible for entry in their Flock Book.

<sup>3</sup> The sum of £15 was given by the Devon Long-Woolled Sheep Breeders' Society towards these prizes.



[Unless otherwise stated, each prize animal named below was "bred by exhibitor."

### South Devons.<sup>1</sup>

**Class 257.**—*South Devon Rams, Shearling and upwards.*  
[6 entries, 1 absent.]

- 2147 I. (£10.)—HENRY FAIRWEATHER, Malston, Sherford, Kingsbridge, for **Stook No. 3 1730**, born Feb., 1905, bred by John Stooke, Sherford, Brixton, Plymouth; **Stooke's Hero 246**.  
2151 II. (£5.)—JOHN STOOKE, Sherford, Brixton, Plymouth, for ram, born Feb., 1906.  
2149 R. N. & H. C.—JOHN S. HALLETT, Sherford, Brixton, Plymouth.

**Class 258.**—*Pens of Three South Devon Shearling Ewes, of the same Flock.*  
[3 entries.]

- 2154 I. (£10), & 2155 R. N. & H. C.—JOHN STOOKE, Sherford, Brixton, Plymouth.  
2153 II. (£5.)—JOHN S. HALLETT, Sherford, Brixton, Plymouth.

### Dartmoors.<sup>2</sup>

**Class 259.**—*Dartmoor Rams, Shearling and upwards.* [3 entries.]

- 2158 I. (£10.)—R. S. LUSCOMBE, Wisdorne, Cornwood, Ivybridge, for **Wisdorne's Pride** born March 10, 1906.  
2156 II. (£5.)—JOHN R. T. KINGWELL, Great Aish, South Brent, Devon, for **Gay La** born March, 1905.  
2157 R. N. & H. C.—JOHN R. T. KINGWELL, for **Topper**.

**Class 260.**—*Pens of Three Dartmoor Shearling Ewes, of the same Flock.*  
[2 entries.]

- 2159 I. (£10), & 2160 II. (£5.)—JOHN R. T. KINGWELL, Great Aish, South Brent.

### Exmoors.<sup>3</sup>

**Class 261.**—*Exmoor Rams, Shearling and upwards.* [3 entries, none absent]

- 2161 I. (£10.)—HEBER MARDON, Ashwick, Dulverton, for **Ashwick Wonder**, born March, 1904, bred by Fred Yeandle, Nadrid, South Molton.  
2162 II. (£5.)—D. J. TAPP, Highercombe, Dulverton, for ram, born Feb. 20, 1905.

**Class 262.**—*Pens of Three Exmoor Shearling Ewes, of the same Flock.*  
[2 entries.]

- 2165 I. (£10.)—D. J. TAPP, Highercombe, Dulverton; s. Highercombe No. 1.  
2164 II. (£5.)—HEBER MARDON, Ashwick, Dulverton.

### Cheviots.<sup>4</sup>

**Class 263.**—*Cheviot Rams, Shearling and upwards.*  
[4 entries, none absent.]

- 2168 I. (£10.)—JACOB ROBSON, Byrness, Otterburn, for ram, born April, 1905.  
2169 II. (£5.)—JOHN ROBSON, JUN., Llynogur, Watten, Caithness, for ram, born Apr 1906, bred by John Robson, Newton, Bellingham.  
2168 R. N. & H. C.—JOHN ROBSON, Newton, Bellingham.

**Class 264.**—*Pens of Three Cheviot Shearling Ewes, of the same Flock.* [3 entries]

- 2170 I. (£10), & 2171 R. N. & H. C.—JACOB ROBSON, Byrness, Otterburn.  
2172 II. (£5.)—JOHN ROBSON, Newton, Bellingham.

### Lonks.<sup>5</sup>

**Class 265.**—*Lonk Rams, Shearling and upwards.* [3 entries, none absent.]

- 2175 I. (£10.)—DAVID HAGUE, Copy Nook, Clitheroe, for **Worsthorne Wonder 64**, born April 20, 1904, bred by Frank Ormerod, Worsthorne, Burnley.  
2173 II. (£5.)—JOHN BLACKBURN, 227 Barkerhouse Road, Nelson, for **Perfection 3rd 4** born March 28, 1905; s. Perfection 1st, d. Lower Laith Queen.

<sup>1</sup> The sum of £10 was given by the South Devon Flock Book Association towards these Prizes.

<sup>2</sup> The sum of £10 was given by Breeders of Dartmoors towards these Prizes.

<sup>3</sup> The sum of £10 was given by the Exmoor Sheep Breeders' Society towards these Prizes.

<sup>4</sup> The sum of £10 was given by the Cheviot Sheep Society towards these Prizes.

<sup>5</sup> The sum of £10 was given by the Lonk Sheep Breeders' Association towards these Prizes.

## xcviii *Award of Live Stock Prizes at Lincoln, 1907.*

[Unless otherwise stated, each prize animal named below was "bred by exhibitor."]

**Class 266.**—*Pens of Three Lonk Shearling Ewes, of the same Flock.*

[3 entries.]

- 2178 I. (£10).—EDWARD SMITH, Summerhouse Farm, Cowling, Keighley, for Pansy, Primrose, and Princess; s. Tombeau 80.  
2177 II. (£5).—DAVID HAGUE, Copy Nook, Clitheroe; s. Worsthorne Wonder 64.

### **Herdwicks.<sup>1</sup>**

**Class 267.**—*Herdwick Rams, Shearling and upwards.* [2 entries.]

- 2180 I. (£10).—W. J. CROSSLEY, M.P., Pullwoods, Ambleside, for Kingmoor 4th, born May 6, 1906; s. Kingmoor 3rd, d. Park Royal by Cardiff Hero.  
2179 II. (£5).—W. J. CROSSLEY, M.P., for Kingmoor 3rd, born April 15, 1904, bred by T. N. Clark, Pullwoods, Ambleside; s. Bloomer d. Ladymoor by Royal Prince.

**Class 268.**—*Pens of Three Herdwick Shearling Ewes, of the same Flock.*

[2 entries.]

- 2181 I. (£10), & 2182 II. (£5).—W. J. CROSSLEY, M.P., Pullwoods, Ambleside; s. Kingmoor 3rd.

### **Welsh Mountain.**

**Class 269.**—*Welsh Mountain Rams, Shearling and upwards.*

[9 entries, 2 absent.]

- 2190 I. (£10).—THE UNIVERSITY COLLEGE OF NORTH WALES, Madryn, Aber, Bangor, for Glaurafon Cymro Goren, born March, 1906, bred by W. Conwy Bell, Brynnyfnon, Rhuddlan; s. Cymro Ieuanic.

- 2187 II. (£5).—J. LL. GRATTON, Voryd Fawr Farm, Abergele, for Young Hero, born April 14, 1906.

- 2191 E. N. & H. C.—THE UNIVERSITY COLLEGE OF NORTH WALES.

**Class 270.**—*Pens of Three Welsh Mountain Shearling Ewes, of the same Flock.*

[7 entries, 1 absent.]

- 2197 I. (£10).—R. E. JONES, Hafod, Corwen; s. Hafod Dafydd.

- 2196 II. (£5).—HENRY O. ELLIS, Tynhendre, Bangor, for Hendre Wern, Hendre Felan, and Hendre Fawr; s. Hendre W.R., d. Wern Fawr by Brynmelyn Obief.

- 2196 E. N. & H. C.—J. LL. GRATTON, Voryd Fawr Farm, Abergele.

### **Black-faced Mountain.**

**Class 271.**—*Black-faced Mountain Rams, Shearling and upwards.*

[5 entries, 1 absent.]

- 2203 I. (£10).—JOHN ROBSON, JUN., Lynegar, Watten, Caithness, born April, 1906.

**Class 272.**—*Pens of Three Black-faced Mountain Shearling Ewes, of the same flock.* [4 entries, 1 absent.]

- 2205 I. (£10).—TOM IRVING, Forest Hall, Kendal.

## **PIGS.**

### **Large White Breed.**

**Class 273.**—*Large White Boars, farrowed in 1905 or 1906.*

[17 entries, 3 absent.]

- 2222 I. (£10, & E. N. for Champion.<sup>2</sup>)—CHARLES SPENCER, Holywell Manor, St. Ives, for Holywell Czech 2nd 9901, born Jan. 15, 1905, bred by Sanders Spencer & Son; s. Holywell Czech 8807, d. Holywell Kit 18900 by Holywell Day Boy 7751.

- 2224 II. (£5, & Special.<sup>3</sup>)—W. H. & E. WHERRY, Bourne, for Giant Goliath 9995, born March 3, 1905, bred by Richard Stuart, Brook Vale, Sowerby; s. Sowerby Earl 8743, d. Sowerby Belle 3rd 14616 by Borrowfield Clipper 6261.

- 2220 III. (£3).—R. R. ROTHWELL, Fulwood Hall Farm, Preston, for Fulwood Roger 9125, born Feb. 4, 1905, bred by John Blundell, Lower Burrow, Scotforth; s. Shard Roger 8725, d. Shard Floss 12th 17380 by Roger 7203.

- 2212 E. N. & H. C.—THE EARL OF ELLESMERE, for Bottesford Worsley 2nd.

<sup>1</sup> The sum of £10 was given by Breeders of Herdwicks towards these Prizes.

<sup>2</sup> Champion Gold Medal, value £5 5s., given by the National Pig Breeders' Association for the best Boar or Sow in Classes 273-276.

<sup>3</sup> Special Prize of £5 given by the Lincolnshire Agricultural Society, for Members of the Society only, for the best Boar in Classes 273 and 274.

[Unless otherwise stated, each prize animal named below was "bred by exhibitor."]

**Class 274.—Large White Boar Pigs, farrowed in 1907.**

[25 entries, 1 absent.]

- 2226 I. (£10).—D. R. DAYBELL, Bottesford, Nottingham, for boar pig, born Jan. 3; s. Ruddington Roger of Bottesford 10083, d. Bottesford Empress 3rd 18714 by Borrowfield Ringleader 20th 6291.  
 2245 II. (£5).—R. E. ROTHWELL, Fulwood Hall Farm, Preston, for boar pig, born Jan. 2; s. Marshall Baron Fulwood 9971, d. Fulwood Molly 3rd 18728 by Fulwood Duke 8569.  
 2227 III. (£3).—D. R. DAYBELL, for boar pig, born Jan. 3; s. Ruddington Roger of Bottesford 10083, d. Bottesford Perfection 9th by Bottesford Combination 6943.  
 2239 E. N. & H. C.—SIR GILBERT GREENALL, BT., Walton Hall, Warrington.

**Class 275.—Large White Breeding Sows, farrowed in 1903, 1904, or 1905.**

[13 entries, 1 absent.]

- 2258 I. (£10, Champion.<sup>1</sup> & Special.<sup>2</sup>)—R. M. KNOWLES, Colston Bassett Hall, Bingham, for Colston Lass 15th 15562, born Jan. 5, 1904, farrowed March 27, 1907; s. Vanguard 7261, d. Colston Lass 11216 by Ruddington King David 5th 3143.  
 2250 II. (£5).—T. DODD & SONS, Mollington, Chester, for Mollington Countess 2nd 15906, born March 7, 1904, farrowed Jan. 1, 1907, bred by T. G. Frost, Mollington, Banastre, Chester; s. Mollington Sam 2nd 7839, d. Walton Countess 11th 11706 by Walton Laddie 6075.  
 2261 III. (£3).—R. E. ROTHWELL, Fulwood Hall Farm, Preston, for Fulwood Carnation 16912, born Jan. 2, 1904, farrowed Feb. 14, 1907; s. Sowerby Dodger 7951, d. Sowerby Empress 4th 12998 by Borrowfield Clipper 6261.  
 2256 E. N. & H. C. & E. N. for Special.<sup>2</sup>—SIR GILBERT GREENALL, BT., Walton Hall, Warrington, for Walton Beauty 10th.

**Class 276.—Large White Sows, farrowed in 1906.<sup>3</sup>** [14 entries, 2 absent.]

- 2269 I. (£10).—SIR GILBERT GREENALL, BT., Walton Hall, Warrington, for Walton Lady Alice 23rd 19902, born Jan. 3; s. Walton Jerry 2nd 8777, d. Walton Lady Alice 7th 14730 by Walton What's Wanted 5th 7277.  
 2270 II. (£5).—SIR GILBERT GREENALL, BT., for Walton Sunlight 12th 19720, born Jan. 1; s. Bourne Bonnie Boy 9019, d. Walton Sunlight 7th 18198 by Walton King David.  
 2264 III. (£3).—THE EARL OF ELLESMERE, Worsley Hall, Manchester, for Worsley Princess 26th 19770, born Jan. 3; s. Worsley Duke 4th 8083, d. Worsley Princess 3rd 18182 by Bottesford Long Sam 5893.  
 2276 E. N. & H. C.—W. H. & E. WHERRY, Bourne, for Pretty Polly.

**Class 277.—Pens of Three Large White Sow Pigs, farrowed in 1907.**

[15 entries, 2 absent.]

- 2280 I. (£10).—THE EARL OF ELLESMERE, Worsley Hall, Manchester, for pen, born Jan. 3; s. Worsley Eclipse 9th 9365, d. Hope of Worsley 18908 by Sowerby Laddie.  
 2291 II. (£5).—W. H. & E. WHERRY, Bourne, for pen, born Jan. 3; s. Giant Goliath 9865, d. Bourne Madam 7th 18728 by Bourne Chief 7603.  
 2287 III. (£3).—R. E. ROTHWELL, Fulwood Hall Farm, Preston, for pen, born Jan. 2; s. Marshall Baron Fulwood 9971, d. Fulwood Molly 3rd 18728 by Fulwood Duke 8569.  
 2277 E. N. & H. C.—DANIEL R. DAYBELL, Bottesford, Nottingham.

## Middle White Breed.

**Class 278.—Middle White Boars, farrowed in 1905 or 1906.**

[4 entries.]

- 2293 I. (£10, & E. N. for Champion.<sup>4</sup>)—SIR GILBERT GREENALL, BT., Walton Hall, Warrington, for Walton Clumber 4th 9427, born Jan. 8, 1905; s. Walton Clumber 3rd 8879, d. Walton Rose 19th 15136 by Walton John 6755.  
 2294 II. (£5).—CHARLES SPENCER, Holywell Manor, St. Ives, for Holywell Vicar 10301, born Feb. 11, 1905, bred by Sanders Spencer & Son; s. Holywell Viscount 8178, d. Holywell Rosarene 2nd 19892 by Holywell Middleton 8169.  
 2292 III. (£3).—SIR GILBERT GREENALL, BT., for Brockhall Clumber 10265, born Sept. 3, 1905; s. Walton Clumber 3rd 8879, d. Walton Rose 19th 15136 by Walton John 6755.  
 2295 E. N. & H. C.—A. C. TWENTYMAN, Castlecroft, Wolverhampton, for Castlecroft Gollwog.

<sup>1</sup> Champion Gold Medal, value £5 5s., given by the National Pig Breeders' Association for the best Boar or Sow in Classes 273-276.

<sup>2</sup> Special Prize of £5 given by the Lincolnshire Agricultural Society for Members of that Society only, for the best Sow in Classes 275 and 276.

<sup>3</sup> Prizes given by the National Pig Breeders' Association.

<sup>4</sup> Champion Gold Medal, value £5 5s., given by the National Pig Breeders' Association for the best Boar or Sow in Classes 278-281.

c *Award of Live Stock Prizes at Lincoln, 1907.*

[Unless otherwise stated, each prize animal named below was "bred by exhibitor."]

**Class 279.—Middle White Boar Pigs, farrowed in 1907.**

[10 entries, 1 absent.]

- 2301 I. (£10.) & 2300 III. (£3.)—LEOPOLD C. PAGET, Harewood, Leeds, for boar pig, born Jan. 9; s. Wharfedale Happy Lad 9467, d. Wharfedale Barmaid 17810 by Holywell Sherborne 8173.  
 2296 II. (£5.)—THE HON. D. P. BOUVERIE, Coleshill House, Highworth, for boar pig, born Jan. 5; s. Coleshill Dandy 8119, d. Coleshill Jewel 2nd 14980 by Coleshill Duke.  
 2299 E. N. & H. C.—LEOPOLD C. PAGET.

**Class 280.—Middle White Breeding Sows, farrowed in 1903, 1904, or 1905.**

[5 entries, 1 absent.]

- 2306 I. (£10. & Champion.)—SIR GILBERT GREENALL, BT., Walton Hall, Warrington, for Walton Rose 39th 17760, born Feb. 3, 1905, farrowed Jan. 20, 1907; s. Offley John 7395, d. Walton Rose 22nd 15142 by Walton Dainty 6753.  
 2308 II. (£5.)—LEOPOLD C. PAGET, Harewood, Leeds, for Holywell Barbara 16320, born Jan. 1, 1903, farrowed Feb. 10, 1907, bred by Sanders Spencer, Holywell Manor, St. Ives; s. Holywell Middleton 8169, d. Holywell Curly Rose 2nd by Holywell Count Curly 5715.  
 2309 III. (£3.)—LEOPOLD C. PAGET, for Warren Sweetbriar 17904, born March 7, 1905, farrowed Jan. 3, 1907, bred by T. Simpson Jay, Warren Farm, Wimbledon; s. Holywell Manchester 8855, d. Warren Rosy Dawn 16376 by Sherborne Baron 7409.  
 2310 E. N. & H. C.—A. C. TWENTYMAN, for Castlecroft Lobelia.

**Class 281.—Middle White Sows, farrowed in 1906.\***

[9 entries, 1 absent.]

- 2313 I. (£10.) SIR GILBERT GREENALL, BT., Walton Hall, Warrington, for sow, born Feb. 1; s. Walton Rufus 2nd 9437, d. Walton Rose 38th 17758 by Offley John 7395.  
 2314 II. (£5.)—LEOPOLD C. PAGET, Harewood, Leeds, for Victoria of Wharfedale 19984, born Jan. 2, bred by T. Simpson Jay, Warren Farm, Wimbledon; s. Holywell Manchester 8855, d. Holywell Vic Countess 13294 by Holywell Count Curly 5715.  
 2311 III. (£3.)—SIR GILBERT GREENALL, BT., for Walton Rose 56th 18992, born Feb. 10; s. Offley John 7395, d. Walton Rose 22nd 15142 by Walton Dainty 6753.  
 2316 E. N. & H. C.—CHARLES SPENCER, for Holywell Victress.

**Class 282.—Pens of Three Middle White Sow Pigs, farrowed in 1907.**

[8 entries, none absent.]

- 2323 I. (£10.)—LEOPOLD C. PAGET, Harewood, Leeds, for pen, born Jan. 5 and 9; s. Offley Dandy 9417 and Wharfedale Happy Lad 9467, ds. Wharfedale Rosalind 16388 by Holywell Middleton 8169, and Wharfedale Barmaid 17810 by Holywell Sherborne.  
 2325 II. (£5.)—THE EARL OF SEFTON, Croxteth Hall, Liverpool, for pen, born Jan. 4; s. Walton Turret 12th 9453, d. Tabook Pattie 1st 19972 by Walton Rufus 8215.  
 2328 III. (£3.)—CHARLES SPENCER, Holywell Manor, St. Ives, for pen, born Jan. 1; s. Holywell Rosario 8857 and Simpson of Holywell 10315, ds. Holywell Vicarress 19006 by Holywell Viscount 8179, and Holywell Rosadora 3rd 18888 by Holywell Viscount.  
 2320 E. N. & H. C.—THE HON. D. P. BOUVERIE, Coleshill House, Highworth.

**Tamworth Breed.**

**Class 283.—Tamworth Boars, farrowed in 1905 or 1906.**

[10 entries, 4 absent.]

- 2330 I. (£10.)—ROBERT IBBOTSON, The Hawthorns, Knowle, Warwickshire, for Knowle Don 10393, born July 11, 1906; s. Cicero 9475, d. Knowle Beauty 2nd 17886 by Rolleston Victor 8375.  
 2333 II. (£5.)—W. H. MITCHELL, Elmdene, Kenilworth, for Elmdene Magnum 2nd 10385, born Aug. 10, 1906; s. Mountain 10491, d. Elmdene Matron 5th 20110 by Elmdene Magnum 8939.  
 2332 III. (£3.)—ROBERT IBBOTSON, for Lydney Red Gauntlet 9517, born June 21, 1905, bred by Charles Bathurst, Jun., Redhill, Lydney; s. Whitacre Cockney 8995, d. Whitacre Fancy 16022 by Whitacre Bounder 7511.  
 2329 E. N. & H. C.—EGBERT DE HAMEL, for Middleton Manual.

**Class 284.—Tamworth Boar Pigs, farrowed in 1907. [10 entries, 3 absent.]**

- 342 I. (£10.)—ROBERT IBBOTSON, The Hawthorns, Knowle, for boar pig, born Jan. 15; s. Rolleston Victor 8375, d. Cholderton Favourite 11th 13400 by Knowle Forester 5369.  
 347 II. (£5.)—SIR PETER C. WALKER, BT., Osmaston Manor, Derby, for Osmaston Pride, born Jan. 8, bred by John Myatt, Lynn House, Walsall; s. Lynn Rover 9523, d. Lynn Beauty 16524 by Lynn Hero 8959.

\* Champion Gold Medal, value £5 5s., given by the National Pig Breeders' Association, the best Boar or Sow in Classes 278-281.

\* Prizes given by the National Pig Breeders' Association.

[Unless otherwise stated, each prize animal named below was "bred by exhibitor."]

- 2341 III. (£3.)—ROBERT IBBOTSON, for boar pig, born Jan. 12, bred by Mrs. E. Ibbotson, Gun Hill, Arley; s. Scarlet Gem 9553, d. Gun Hill Gem 3rd by Whitacre Radium 8987.  
 2338 R. N. & H. C.—EGBERT DE HAMEL, Middleton Hall, Tamworth.

Class 235.—*Tamworth Breeding Sows, farrowed in 1903, 1904, or 1905.*  
 [6 entries, 2 absent.]

- 2363 I. (£10, & R. N. for Champion.<sup>1</sup>)—SIR PETER C. WALKER, BT., Osmaston Manor, Derby, for Osmaston Marigold 3rd 20268, born Aug. 10, 1905, farrowed Jan. 13, 1907; s. Osmaston Prince 836i, d. Osmaston Marigold 2nd 17964 by Mickleover Duke 7489.  
 2362 II. (£5.)—SIR PETER C. WALKER, BT., for Osmaston Daisy 17960, born Sept. 27, 1904, farrowed Jan. 2, 1907; s. Mickleover Duke 7489, d. Osmaston Pansy 2nd 17966 by Mickleover Duke 7489.  
 2360 III. (£3.)—W. J. PITT, The Albynes, Bridgnorth, for Albynes 20023, born Feb. 20, 1903, farrowed Feb. 23, 1907; s. Whitacre Bounder 7511, d. Westwood Lady 12178 by Westwood Welshman 6849.  
 2348 R. N. & H. C.—ROBERT IBBOTSON, The Hawthorns, Knowle, for Knowle Doris.

Class 236.—*Tamworth Sows, farrowed in 1906<sup>2</sup>.* [9 entries, 1 absent.]

- 2366 I. (£10, & Champion.<sup>1</sup>)—F. W. GILBERT & CO., Cuttle Bridge Creamery, Swarkestone, Derby, for Whitacre Grace 20324, born Jan. 5, bred by D. W. Philip, Redlands, Whitacre; s. Whitacre Radium 8987, d. Whitacre Cherry 13664 by Amington Duke 5753.  
 2364 II. (£5.)—EGBERT DE HAMEL, Middleton Hall, Tamworth, for Middleton Morgana 20250, born Jan. 1; s. Middleton Majestic 8971, d. Middleton Megallie 18676 by Middleton Mainspring 6825.  
 2368 III. (£3.)—ROBERT IBBOTSON, The Hawthorns, Knowle, for Knowle Sylvia 20178, born July 11; s. Cicero 9475, d. Knowle Beauty 2nd 17886 by Rolleston Victor 8375.  
 2369 R. N. & H. C.—JOHN MYATT, Lynn House, Lichfield, for Lynn Lucy 2nd.

Class 237.—*Pens of Three Tamworth Sow Pigs, farrowed in 1907.*  
 [9 entries, 3 absent.]

- 2367 I. (£10.)—ROBERT IBBOTSON, The Hawthorns, Knowle, for pen, born Jan. 15; s. Rolleston Victor 8375, d. Cholderton Favourite 11th 13400 by Knowle Forester 5369.  
 2366 II. (£5.)—ROBERT IBBOTSON, for pen, born Jan. 12, bred by Mrs. E. Ibbotson, Gun Hill, Arley; s. Scarlet Gem 9553, d. Gun Hill Gem 3rd by Whitacre Radium 8987.  
 2369 III. (£3.)—JOHN MYATT, Lynn House, Lichfield, for pen, born Jan. 8; s. Lynn Rover 9623, d. Lynn Beauty 16528 by Lynn Hero 8659.  
 2363 R. N. & H. C.—EGBERT DE HAMEL, Middleton Hall, Tamworth.

## Berkshire Breed.

Class 238.—*Berkshire Boars, farrowed in 1905 or 1906.*  
 [20 entries, 2 absent.]

- 2380 I. (£10, & Champion.<sup>3</sup>)—G. T. INMAN, Highmoor Hall, Henley-on-Thames, for Highmoor Curio 11807, born Jan. 3, 1906; s. Highmoor Mikado 10433, d. Danesfield Bluebell 8757 by Danesfield Haymaker 8236.  
 2379 II. (£5, & R. N. for Champion.<sup>3</sup>)—R. W. HUDSON, Danesfield, Marlow, for Danesfield Robert 11224, born Aug. 1, 1905; s. Baron Kitchener 8403, d. Danesfield Sis 9425 by Manor Favourite 7831.  
 2374 III. (£3.)—G. J. B. CHETWYND, Wyndthorpe, Doncaster, for Highmoor Santoi 11805, born Jan. 3, 1906, bred by G. T. Inman, Highmoor Hall, Henley-on-Thames; s. Highmoor Mikado 10433, d. Danesfield Bluebell 8757 by Danesfield Haymaker 8236.  
 2378 R. N. & H. C.—F. A. HOLMAN, Dunley Manor, Whitechurch, Hants, for Dunley Lad.

Class 239.—*Berkshire Boar Pigs, farrowed in 1907.*  
 [20 entries, 3 absent.]

- 2397 I. (£10.)—G. J. B. CHETWYND, Wyndthorpe, Doncaster, for boar pig, born Jan. 17; s. Don Confidence 10987, d. Danesfield May Queen 10359 by Danesfield Don 9432.  
 2396 II. (£5.)—G. J. B. CHETWYND, for boar pig, born Jan. 13; s. Don Confidence 10987, d. Happy Doon 11123 by Ruddington Monitor 8917.  
 2403 III. (£3.)—G. T. INMAN, Highmoor Hall, Henley-on-Thames, for boar pig, born Jan. 5; s. Highmoor Mikado 10433, d. Compton Jewel 9605 by Baron Kitchener 8403.  
 2392 R. N. & H. C.—NATHANIEL BENJAFIELD, Motcombe, Shaftesbury.

<sup>1</sup> Champion Gold Medal, value £5 5s., given by the National Pig Breeders' Association for the best Boar or Sow in Classes 233-236.

<sup>2</sup> Prizes given by the National Pig Breeders' Association.

<sup>3</sup> Champion Gold Medal, value £5 5s., given by the British Berkshire Society for the best Boar in Classes 238 and 239.

cii *Award of Live Stock Prizes at Lincoln, 1907.*

[Unless otherwise stated, each prize animal named below was "bred by exhibitor."]

**Class 290.—Berkshire Breeding Sows, farrowed in 1903, 1904, or 1905.**

[13 entries, 2 absent.]

- 2413 I. (£10, & Champion.<sup>1</sup>)—THE DUCHESS OF DEVONSHIRE, Compton Place, Eastbourne, for Polegate Dorcas 2nd 12213, born June 18, 1905, farrowed Jan. 10, 1907, bred by R. B. Vincent, Compton Valence, Dorchester; s. Supreme's Boy 9743, d. Compton Rosebud 11181 by Compton Bruce 9602.
- 2421 II. (£5.)—THE VISITING COMMITTEE, MIDDLESEX COUNTY ASYLUM, Tooting, Surrey, for Belle of Balham 13th 11044, born Aug. 23, 1904, farrowed Jan. 2, 1907; s. Motcombe Prince 9667, d. Belle of Balham 3rd 8732 by Marah 7190.
- 2412 III. (£3.)—LORD CALTHORPE, Elvetham Park, Winchfield, for Elvetham Beauty 10473, born Aug. 10, 1903, farrowed Feb. 10, 1907, bred by R. B. Vincent, Compton Valence, Dorchester; s. Compton Bruce 9602, d. Compton Whiteface 9600 by Stratton Duke 8222.
- 2419 E. N. & H. C.—J. JEFFERSON, Peel Hall, Ochester, for Barford Rosa.

**Class 291.—Berkshire Sows, farrowed in 1906.<sup>2</sup>** [20 entries, 7 absent.]

- 2427 I. (£10, & R. N. for Champion.<sup>1</sup>)—LORD CALTHORPE, Elvetham Park, Winchfield, for Elvetham Fancy 12248, born Jan. 8, bred by R. B. Vincent, Compton Valence, Dorchester; s. Supreme's Boy 9743, d. Compton Fancy 1045 by Compton Bruce 9602.
- 2429 II. (£5.)—THE DUCHESS OF DEVONSHIRE, Compton Place, Eastbourne, for Polegate Duett 12217, born Jan. 24; s. Polegate Drover 10978, d. Polegate Dainty 9160 by Baron Kitchener 8403.
- 2426 III. (£3.)—G. T. INMAN, Highmoor, Highmoor Hall, Henley-on-Thames, for Highmoor Mimosa 11809, born Jan. 3; s. Highmoor Mikado 10433, d. Danesfield Bluebell 6767 by Danesfield Haymaker 8236.
- 2425 E. N. & H. C.—NATHANIEL BENJAFIELD, for Motcombe's Best.

**Class 292.—Pens of Three Berkshire Sow Pigs, farrowed in 1907.**

[17 entries, 4 absent.]

- 2447 I. (£10.)—G. J. B. CHERWYND, Wyndthorpe, Doncaster, for pen, born Jan. 12; s. Don Confidence 10987, d. Happy Doon 11223 by Ruddington Monitor 8917.
- 2450 II. (£5.)—THE HON. A. HOLLAND-HIBBERT, Munden, Watford, for pen, born Jan. 10; s. Munden Viscount 10885, d. Burbridge 22nd 10987 by Munden Baronet 9472.
- 2445 III. (£3.)—NATHANIEL BENJAFIELD, Shorts Green Farm, Motcombe, Shaftesbury, for pen, born Jan. 2 and 3; ss. Okeford Edward 10777 and Eccalin Charmer 9950, ds. Velmore Duchess 10458 by Velmore Duke 10034 and Motcombe Josephine 12307 by Commander-in-Chief 10090.
- 2457 E. N. & H. C.—THE VISITING COMMITTEE, MIDDLESEX COUNTY ASYLUM.

## Large Black Breed.

**Class 293.—Large Black Boars, farrowed in 1905 or 1906.**

[18 entries, 1 absent.]

- 2466 I. (£10, & Champion.<sup>2</sup>)—HENRY J. KINGWELL, Great Aish, South Brent, Devon, for Brent Pride 2nd 1379, born April 1, 1905; s. Treacowe Pride 875, d. Sally 2014.
- 2467 II. (£5.)—WILLIAM KNIGHT, Wintringham Hall, St. Neots, for Wintringham Ascotic Silver 1761, born April 19, 1905; s. Menna Wonder 1181, d. Menna Model 3rd 1352 by Tinten Squire 401.
- 2473 III. (£3.)—JOHN WARNE, Treveglas Farm, St. Mabyn, R.S.O. for Treveglas Chief 1903, born June 18, 1906; s. Brent Chief 1243, d. Treveglas Lady 5404 by Cornish King.
- 2464 E. N. & H. C.—T. F. HOOLEY, Papworth, Cambridge, for Stroud Masterpiece.

**Class 294.—Large Black Boar Pigs, farrowed in 1907.** [17 entries, 4 absent.]

- 2494 I. (£10, & R. N. for Champion.<sup>2</sup>)—JOHN WARNE, Treveglas Farm, St. Mabyn, for boar pig, born Jan. 6; s. Brent Chief 1243, d. Treveglas Lady 5404 by Cornish King.
- 2482 II. (£5.)—JOHN H. GLOVER, Cornwood, Ivybridge, for Cornwood Viscount, born Jan. 8; s. Cornish King 893, d. Cornwood Lass 20th 5020 by General Buller 327.
- 2490 III. (£3.)—KENNETH M. CLARK, Sudbourne Hall, Orford, for boar pig, born Jan. 2; s. Sudbourne Start 2nd 1221, d. Sudbourne Sall A. 3346 by Sudbourne Sam 244.
- 2483 E. N. & H. C.—THOMAS GOODCHILD, Great Yeldham Hall, Castle Hedingham.

<sup>1</sup> Champion Gold Medal, value £5 5s., given by the British Berkshire Society for the best Sow in Classes 290 and 291.

<sup>2</sup> Prizes given by the British Berkshire Society.

<sup>3</sup> Champion Prize of £10 given by the Large Black Pig Society for the best Boar in Classes 293 and 294.

## Large Black and Lincolnshire Curly-coated Pigs. ciii

[Unless otherwise stated, each prize animal named below was "bred by exhibitor."]

**Class 295.**—*Large Black Breeding Sows, farrowed in 1903, 1904, or 1905.*

[11 entries, none absent.]

2606 I. (£10. & Champion.<sup>1</sup>)—JOHN WARNE, Treveglas Farm, St. Mabyn, for Treveglas Hopeful 2nd 4998, born Feb. 1, 1905, farrowed Jan. 30, 1907; s. Trevisquite Longfellow 365, d. Treveglas Hopeful 2580 by Trevisquite Leader 403.

2604 II. (£5.)—C. F. MARRINER, Thorpe Hall, Hasketon, Woodbridge, for Hasketon Long Lady 359<sup>2</sup>, born Jan. 14, 1903, farrowed Feb. 5, 1907; s. Royal Bodmin 455, d. Long Lady 1808 by Launceston Duke 395.

2602 III. (£3.)—C. F. MARRINER, for Hasketon Long Bess 3rd 4154, born Feb. 14, 1903, farrowed March 16, 1907; s. Black King 545, d. Long Bess 2nd 1806 by Launceston Duke 395.

2600 E. N. & H. C.—JOHN H. GLOVER, Cornwood, Ivybridge, for Cornwood Lass 20th.

**Class 296.**—*Large Black Sows, farrowed in 1906.*<sup>2</sup> [13 entries, 2 absent.]

2610 I. (£10. & E. N. for Champion.<sup>1</sup>)—HENRY J. KINGWELL, Great Aish, South Brent, for Brent Pretty Fanny 5838, born Feb. 9; s. Trescowe Pride 875, d. Brent Pretty Lass 4374 by General Buller 327.

2616 II. (£5.)—JOHN WARNE, Treveglas Farm, St. Mabyn, for Treveglas Lass 2nd 6220, born May 18; s. Trevisquite Confidence 1203, d. Treveglas Lass 4898 by Trevisquite Cornish 937.

2611 III. (£3.)—HENRY J. KINGWELL, for Brent Susie 6192, born April 1; s. Trescowe Pride 875, d. Sally 2014.

2619 E. N. & H. C.—W. J. WARREN, Mill House, Ash Priors, Taunton, for Ashmill Susie.

**Class 297.**—*Pens of Three Large Black Sow Pigs, farrowed in 1907.*

[9 entries, 3 absent.]

2523 I. (£10.)—THOMAS GOODCHILD, Great Yeldham Hall, Castle Hedingham, for pen, born Jan. 10; s. Trescowe Prince 657, d. Tartar Princess 21st 3850 by Black Akenham 309.

2527 II. (£5.)—THOMAS WARNE, Trevisquite Manor, St. Mabyn, for pen, born Jan. 5; s. Brent Chief 1243, d. Trevisquite Lady 3024 by Trevisquite Leader 403.

2528 III. (£3.)—THOMAS WARNE, for pen, born Jan. 6; s. Brent Chief 1243, d. Trevisquite Crafty 2nd 2548 by Trevisquite Leader 403.

2525 E. N. & H. C.—C. F. MARRINER, Thorpe Hall, Hasketon, Woodbridge.

## Lincolnshire Curly-coated Breed.

**Class 298.**—*Lincolnshire Curly-coated Boars, farrowed in 1905 or 1906.*

[13 entries, 1 absent.]

2542 I. (£10. and Special.<sup>3</sup>)—JOSEPH WARD, Moulton Park, Spalding, for Whaplode Curly 337, born March, 1905, bred by C. Skinner, Leake, Boston.

2535 II. (£5.)—HENRY CAUDWELL, Midville, Boston, for Midville Bob 223, born March, 1905, bred by C. Skinner, Old Leake, Boston.

2541 III. (£3.)—BENJAMIN ROWLAND, Ivy House, Wainfleet, for Wainfleet Ringleader 327, born March 15, 1905, bred by S. E. Dean & Sons, Dowsby Hall, Bourne; s. Dowsby Rex 77.

2538 E. N. & H. C.—C. E. HARRIS & SONS, Heckington, for Hale Gentleman.

**Class 299.**—*Lincolnshire Curly-coated Boar Pigs, farrowed in 1907.*<sup>4</sup>

[13 entries, 3 absent.]

2555 I. (£10. & E. N. for Special.<sup>3</sup>)—THOMAS WARD, Carrington Grange, Boston, for boar pig, born Jan. 18, bred by T. Ward & Son; s. Midville Bob 223, d. Leadenhall Active 514 by Leadenhall Toby 193.

2544 II. (£5.) & 2545 III. (£3.)—HENRY CAUDWELL, Midville, Boston, for boar pig, born Jan. 9; s. Midville Bob 223, d. Midville Beauty 3rd 598 by Midville Casswell 221.

2550 E. N. & H. C.—GEORGE GODSON, Asgarby, Heckington.

**Class 300.**—*Lincolnshire Curly-coated Breeding Sows, farrowed in 1903, 1904, 1905, or 1906.*<sup>5</sup> [10 entries, 1 absent.]

2558 I. (£10. & Special.<sup>3</sup>)—HENRY CAUDWELL, Midvil e, Boston, for Midville A1 588, born in April, 1903, farrowed Jan. 18, 1907; s. Midville Peter 217, d. Midville Daisy 588 by Midville Marshman 215.

<sup>1</sup> Silver Challenge Cup, value Twenty Guineas, given by the Large Black Pig Society for the best Sow in Classes 295 and 296, the Cup to become the absolute property of an Exhibitor winning it twice in succession or three times in all.

<sup>2</sup> Prizes given by the Large Black Pig Society.

<sup>3</sup> Special Prize of £5 given by the Lincolnshire Agricultural Society, for Members of that Society only, for the best Boar in Classes 298 and 299.

<sup>4</sup> Prizes given by the Lincolnshire Curly-Coated Pig Breeders' Association.

<sup>5</sup> Special Prize of £5 given by the Lincolnshire Agricultural Society, for Members of that Society only, for the best Sow in Class 300.

civ *Award of Poultry Prizes at Lincoln, 1907.*

- [Unless otherwise stated, each prize animal named below was "bred by exhibitor."]
- 2563 II. (£5.)—HERBERT S. SCORER, East Kirkby House, Spilsby, for **East Kirkby Alexander** 236, born Dec. 21, 1903, farrowed Feb. 8, 1907, bred by J. Bellamy, Stickney, Boston; s. Stickney Alec 291, d. Stickney Sunbeam 750 by Stickney West House Tom 289.
- 2560 III. (£3, & E. N. for Special.<sup>1</sup>)—JOSEPH BREWERY & SON, Wilkes Manor House, Donington, Spalding, for **Donington Superior** 176, born July 27, 1904, farrowed March 8, 1907; s. Donington Premier 57, d. Donington Best by Jumbo.
- 2561 E. N. & H. C.—GEORGE FREIR, Deeping St. Nicholas, Spalding, for **Deeping Pride**.
- Class 301.—Pens of Three Lincolnshire Curly-coated Sow Pigs, farrowed in 1907.<sup>2</sup> [10 entries, 4 absent.]**
- 2568 I. (£10.)—HENRY CAUDWELL, Midville, Boston, for pen, born Jan. 9; s. Midville Bob 223, d. Midville Beauty 3rd 598, by Midville Caswell 221.
- 2574 II. (£5.)—THOMAS WARD, Carrington Grange, Boston, for pen, born Jan. 18; s. Midville Bob 223, d. Leadenhall Active 514 by Leadenhall Toby 193.
- 2566 III. (£3.)—S. E. DEAN & SONS, Dowsby Hall, Bourne, for pen, born Jan. 21; s. Dowsby Lincoln 1st 79, d. Dowsby Queen 218 by Dowsby Rex 77.
- 2575 E. N. & H. C.—H. G. THORPE, Hemswell Grange, Lincoln.

## POULTRY.

By "Cock," "Hen," "Drake," "Duck," "Gander," and "Goose" are meant birds hatched previous to January 1, 1907; and by "Cockerel," "Pullet," "Young Drake," and "Duckling," are meant birds hatched in 1907, previous to June 1.

### Game.

- Class 302.—Old English Game Cocks.** [15 entries, 2 absent.]
- 2568 I. (20s.)—T. C. HEATH, Keele, Newcastle, Staffs.
- 2562 II. (10s.)—HARRY S. HASSALL, The Cedars, Ashby-de-la-Zouch.
- 2561 III. (5s.)—MRS. A. L. A. GREAVES, Haversham Fields Poultry Farm, Wolverton.
- 2576 E. N. & H. C.—THE COUNTESS OF CRAVEN, Coombe Abbey, Coventry.
- Class 303.—Old English Game Hens.** [10 entries, none absent.]
- 2566 I. (20s. & E. N. for Special.<sup>3</sup>)—HARRY S. HASSALL, The Cedars, Ashby-de-la-Zouch.
- 2591 II. (10s.)—THE COUNTESS OF CRAVEN, Coombe Abbey, Coventry.
- 2566 III. (5s.)—T. C. HEATH, Keele, Newcastle, Staffs.
- 2598 E. N. & H. C.—JOSEPH ROBSON, Prospect House, Brampton, Cumberland.
- Class 304.—Old English Game Cockerels.** [6 entries, 1 absent.]
- 2604 I. (20s.)—T. C. HEATH, Keele, Newcastle, Staffs.
- 2603 II. (10s.)—HARRY S. HASSALL, The Cedars, Ashby-de-la-Zouch.
- 2601 III. (5s.)—THE COUNTESS OF CRAVEN, Coombe Abbey, Coventry.
- 2606 E. N. & H. C.—D. & C. PEARY, 50 Third Row, Ashington, Morpeth.
- Class 305.—Old English Game Pullets.** [5 entries, none absent.]
- 2610 I. (20s.)—T. C. HEATH, Keele, Newcastle, Staffs.
- 2607 II. (10s.)—THE COUNTESS OF CRAVEN, Coombe Abbey, Coventry.
- 2608 III. (5s.)—PHILIP ALFRED FISHER, Carhead, Crosshills, near Kelghley.
- 2609 E. N. & H. C.—HARRY S. HASSALL, The Cedars, Ashby-de-la-Zouch.
- Class 306.—Indian Game Cocks.** [11 entries, 2 absent.]
- 2615 I. (20s. & Special.<sup>3</sup>)—JAMES FRAYNE & SONS, Piper's Pool, Egloskerry, R.S.O.
- 2618 II. (10s.)—HARRY S. HASSALL, The Cedars, Ashby-de-la-Zouch.
- 2614 III. (5s.)—FIRTH BROS., Wharton Farm, Acton Vale, W.
- 2622 E. N. & H. C.—TOM WOODCOCK, Burton Fen Poultry Farm, Lincoln.
- Class 307.—Indian Game Hens.** [12 entries, 2 absent.]
- 2627 I. (20s.)—JAMES FRAYNE & SONS, Piper's Pool, Egloskerry, R.S.O.
- 2628 II. (10s.)—FIRTH BROS., Wharton Farm, Acton Vale, W.
- 2630 III. (5s.), & 2631 E. N. & H. C.—HARRY S. HASSALL, Ashby-de-la-Zouch.
- Class 308.—Indian Game Cockerels.** [6 entries, 2 absent.]
- 2636 I. (20s.)—WILLIAM BRENT, Clampton Farm, Callington.
- 2637 II. (10s.)—GEORGE FAULKNER, Rowton, Chester.
- 2638 III. (5s.)—JAMES FRAYNE & SONS, Piper's Pool, Egloskerry, R.S.O.
- 2635 E. N. & H. C.—H. ANNINGSO, Manor House, Humberstone, Grimsby.

<sup>1</sup>Special Prize of £5 given by the Lincolnshire Agricultural Society, for Members of that Society only, for the best Sow in Class 300.

<sup>2</sup>Prizes given by the Lincolnshire Curly-Coated Pig Breeders' Association, Special Prize of 20s. given for the best bird in Classes 302-309.



## Game, Langshan, and Plymouth Rock Fowls. cv

### Class 309.—*Indian Game Pullets.* [7 entries, 1 absent.]

- 2644 I. (20s.)—JAMES FRAYNE & SONS, Piper's Pool, Egloskerry, R.S.O.  
2645 II. (10s.)—HARRY S. HASSALL, The Cedars, Ashby-de-la-Zouch.  
2643 III. (5s.)—GEORGE FAULKNER, Rowton, Chester.  
2646 R. N. & H. C.—HERBERT JACKSON, 15 Mark Street, Cardiff.

### Langshans.

#### Class 310.—*Langshan Cocks or Cockerels.* [9 entries, none absent.]

- 2648 I. (20s.)—R. ANTHONY, Home Farm, Euxton, Chorley.  
2650 II. (10s.)—REUBEN CLARKE, Eaton, Tarporley.  
2656 III. (5s.)—HARRY WALLIS, Warley, Brentwood.  
2655 R. N. & H. C.—MISS IDA VERREY, The Warren, Oxshott.

#### Class 311.—*Langshan Hens or Pullets.* [11 entries, none absent.]

- 2658 I. (20s.)—G. FIELDER, 19 Worpole Road, Wimbledon.  
2657 II. (10s.)—R. ANTHONY, Home Farm, Euxton, Chorley.  
2661 III. (5s.)—JOSEPH PICKERILL, Broomhall School, Nantwich.  
2663 R. N. & H. C.—J. W. TAYLOR, Jessamine Cottage, Riddings, Alfreton.

### Plymouth Rocks.

#### Class 312.—*Plymouth Rock Barred Cocks.* [7 entries, 2 absent.]

- 2669 I. (20s.)—JAMES BATEMAN, Milnthorpe, Westmorland.  
2674 II. (10s.)—TOM WOODCOCK, Burton Fen Poultry Farm, Lincoln.  
2673 III. (5s.)—E. MARSHALL, Hollyhurst, Lenton, Nottingham.  
2668 R. N. & H. C.—ABBOT BROS., Thuxton, Norfolk.

#### Class 313.—*Plymouth Rock Barred Hens.* [7 entries, none absent.]

- 2676 I. (20s.)—JAMES BATEMAN, Milnthorpe, Westmorland.  
2677 II. (10s.)—J. MARSDEN CHANDLER, Knifesmith Gate, Chesterfield.  
2678 III. (5s.)—E. MARSHALL, Hollyhurst, Lenton, Nottingham.  
2675 R. N. & H. C.—ABBOT BROS., Thuxton, Norfolk.

#### Class 314.—*Plymouth Rock Barred Cockerels.* [14 entries, 5 absent.]

- 2683 I. (20s.)—J. W. AIREY, Galgate, Lancaster.  
2690 II. (10s.)—G. A. JACKSON, Buckstone House, Carnforth.  
2691 III. (5s.)—GARDNER BROS., Pilling, Garstang.  
2685 R. N. & H. C.—J. MARSDEN CHANDLER, Knifesmith Gate, Chesterfield.

#### Class 315.—*Plymouth Rock Barred Pullets.* [9 entries, none absent.]

- 2702 I. (20s.)—JOHN TAYLOR, Heaton, Lancaster.  
2703 II. (10s.)—MRS. WILKINSON, Burrow House, Scotforth, Lancaster.  
2690 III. (5s.)—GEORGE JACKSON, Silverdale, Carnforth.  
2697 R. N. & H. C.—GARDNER BROS., Pilling, Garstang.

#### Class 316.—*Plymouth Rock Cocks or Cockerels, any other variety.* [17 entries, 1 absent.]

- 2720 I. (20s.)—MRS. WILKINSON, Burrow House, Scotforth, Lancaster. (White.)  
2713 II. (10s.)—GEORGE E. GUSH, Thackham, Winchfield.  
2719 III. (5s.)—JOHN TAYLOR, Heaton, Lancaster.  
2706 R. N. & H. C.—ABBOT BROS., Thuxton, Norfolk. (White.)

#### Class 317.—*Plymouth Rock Hens or Pullets, any other variety.* [10 entries, 1 absent.]

- 2731 I. (20s.)—JOHN TAYLOR, Heaton, Lancaster.  
2730 II. (10s.)—WILLIAM SLATER, Highfield, Lancaster. (White.)  
2723 III. (5s.)—R. ANTHONY, Home Farm, Euxton, Chorley. (White.)  
2722 R. N. & H. C.—ABBOT BROS., Thuxton, Norfolk. (White.)

### Wyandottes.

#### Class 318.—*Gold or Silver Laced Wyandotte Cocks.* [5 entries, 1 absent.]

- 2733 I. (20s., & R. N. for Special.<sup>1</sup>)—O. F. BATES, Harlow Court, Harrogate.  
2734 II. (10s.)—TOM H. FURNESS, Carlton House, Chesterfield.  
2732 III. (5s.)—R. ANTHONY, Home Farm, Euxton, Chorley.  
2735 R. N. & H. C.—A. C. GILBERT, North Bank, St. Mary Cray.

#### Class 319.—*Gold or Silver Laced Wyandotte Hens.* [7 entries, 1 absent.]

- 2738 I. (20s.)—O. F. BATES, Harlow Court, Harrogate.  
2742 II. (10s.)—T. O. HEATH, Keele, Newcastle, Staffs.  
2737 III. (5s.)—R. ANTHONY, Home Farm, Euxton, Chorley.  
2741 R. N. & H. C.—ROBERT GRAY, Bromston Road, Northallerton.

<sup>1</sup> Special Prize of 20s. given for the best bird in Classes 310-354.

cvi *Award of Poultry Prizes at Lincoln, 1907.*

**Class 320.—Gold or Silver Laced Wyandotte Cockerels.**

[5 entries, none absent.]

- 2746 I. (20s.)—T. C. HEATH, Keele, Newcastle, Staffs.  
2744 II. (10s.)—O. F. BATES, Harlow Court, Harrogate.  
2745 III. (5s.)—TOM H. FURNESS, Carlton House, Chesterfield.  
2748 R. N. & H. C.—MARK WALKER, Lower College Farm, Hothersall, Longridge.

**Class 321.—Gold or Silver Laced Wyandotte Pullets.**

[10 entries, 3 absent.]

- 2754 I. (20s.)—T. J. LITTLE, Blackburne Road, Ribchester, Preston.  
2751 II. (10s.)—TOM H. FURNESS, Carlton House, Chesterfield.  
2749 III. (5s.)—O. F. BATES, Harlow Court, Harrogate.  
2753 R. N. & H. C.—R. H. LINGWOOD, Riverside Poultry Yards, Needham Market.

**Class 322.—White Wyandotte Cocks.** [13 entries, none absent.]

- 2759 I. (20s.)—R. ANTHONY, Home Farm, Euxton, Chorley.  
2764 II. (10s.) & 2763 III. (5s.)—C. N. GOODE, Peckfield Lodge, South Milford.  
2760 R. N. & H. C.—H. BONNY, Marton Poultry Yards, Blackpool.

**Class 323.—White Wyandotte Hens.** [7 entries, none absent.]

- 2772 I. (20s.)—R. ANTHONY, Home Farm, Euxton, Chorley.  
2773 II. (10s.)—H. BONNY, Marton Poultry Yards, Blackpool.  
2774 III. (5s.)—C. N. GOODE, Peckfield Lodge, South Milford.  
2778 R. N. & H. C.—HERBERT SPENSLEY, Oaks Farm, Menston, *vid* Leeds.

**Class 324.—White Wyandotte Cockerels.** [13 entries, 4 absent.]

- 2779 I. (20s.)—R. ANTHONY, Home Farm, Euxton, Chorley.  
2790 II. (10s.)—HUBERT WRIGHT, Mayfield, Keighley.  
2783 III. (5s.)—C. N. GOODE, Peckfield Lodge, South Milford.  
2786 R. N. & H. C.—G. BETTS, Goostrey, Holmes Chapel.

**Class 325.—White Wyandotte Pullets.** [12 entries, 2 absent.]

- 2797 I. (20s.) & 2796 II. (10s.)—C. N. GOODE, Peckfield Lodge, South Milford.  
2792 III. (5s.)—R. ANTHONY, Home Farm, Euxton, Chorley.  
2803 R. N. & H. C.—GEORGE L. WARD, 48 Lyndhurst Road, Luton.

**Class 326.—Partridge Wyandotte Cocks.** [18 entries, none absent.]

- 2811 I. (20s.) & 2812 III. (5s.)—MRS. HIRD, Tewitt Hall, Oatworth, Keighley.  
2819 II. (10s.)—JOHN WHARTON, Honeycott Farm, Hawes, Yorks.  
2821 R. N. & H. C.—HUBERT WRIGHT, Mayfield, Keighley.

**Class 327.—Partridge Wyandotte Hens.** [14 entries, 1 absent.]

- 2835 I. (20s.)—HUBERT WRIGHT, Mayfield, Keighley.  
2833 II. (10s.)—W. A. SPOFFORTH, Ivydene, Wragby.  
2834 III. (5s.)—JOHN WHARTON, Honeycott Farm, Hawes, Yorks.  
2822 R. N. & H. C.—ABBOT BROS., Thuxton, Norfolk.

**Class 328.—Partridge Wyandotte Cockerels.** [2 entries.]

- 2837 I. (20s.)—JOHN WHARTON, Honeycott Farm, Hawes, Yorks.  
2836 II. (10s.)—MRS. HIRD, Tewitt Hall, Oatworth, Keighley.

**Class 329.—Partridge Wyandotte Pullets.** [5 entries, none absent.]

- 2839 I. (20s.)—ALFRED HISCOCK, Loddington, Kettering.  
2841 II. (10s.) & 2842 III. (5s.)—HUBERT WRIGHT, Mayfield, Keighley.  
2840 R. N. & H. C.—JOHN WHARTON, Honeycott Farm, Hawes, Yorks.

**Class 330.—Wyandotte Cocks or Cockerels, any other variety.**

[10 entries, 1 absent.]

- 2847 I. (20s.)—T. C. HEATH, Keele, Newcastle, Staffs.  
2852 II. (10s.)—JOHN WHARTON, Honeycott Farm, Hawes, Yorks.  
2843 III. (5s.)—R. ANTHONY, Home Farm, Euxton, Chorley.  
2846 R. N. & H. C.—TOM H. FURNESS, Carlton House, Chesterfield.

**Class 331.—Wyandotte Hens or Pullets, any other variety.**

[12 entries, 1 absent.]

- 2863 I. (20s.)—JOHN WHARTON, Honeycott Farm, Hawes, Yorks.  
2853 II. (10s.)—RICHARD CAPE, The Blands, Wennington, Lancaster.  
2864 III. (5s.)—HUBERT WRIGHT, Mayfield, Keighley.  
2864 R. N. & H. C.—WALTER FOULDS, Kirby Muxioe, Leicester.

## Orpingtons.

Class 332.—*Buff Orpington Cocks.* [26 entries, 1 absent.]

- 2890 I. (20s.)—MRS. WILKINSON, Burrow House, Scotforth, Lancaster.  
 2895 II. (10s.)—R. ANTHONY, Home Farm, Euxton, Chorley.  
 2870 III. (5s.)—W. H. COOK, Model Poultry Farm, St. Paul's Cray.  
 2899 E. N. & H. C.—W. COOK & SONS, Orpington House, St. Mary Cray.

Class 333.—*Buff Orpington Hens.* [15 entries, 2 absent.]

- 2892 I. (20s.)—FRANK BLOOMER, Foxcote, Stourbridge.  
 2896 II. (10s.)—A. C. GILBERT, North Bank, St. Mary Cray.  
 2903 III. (5s.)—ALEX. REITH, Eddlewood, Ayr.  
 2906 E. N. & H. C.—F. W. TAYLOR & CO., The Firs, Heronsgate, Rickmansworth.

Class 334.—*Buff Orpington Cockerels.* [17 entries, none absent.]

- 2921 I. (20s.)—JAMES TURNER, Bentham Poultry Yards, Bentham.  
 2822 II. (10s.)—MRS. WILKINSON, Burrow House, Scotforth, Lancaster.  
 2849 III. (5s.)—ENTWISTLE BROS., Westhoughton, Lancashire.  
 2910 E. N. & H. C.—WILLIAM EVANS, Orpington Poultry Farm, Coppenthal, Crewe.

Class 335.—*Buff Orpington Pullets.* [23 entries, 3 absent.]

- 2943 I. (20s., & Special), & 2942 II. (10s.)—JAMES TURNER, Bentham Poultry Yards.  
 2944 III. (5s.), & 2945 E. N. & H. C.—MRS. WILKINSON, Scotforth, Lancaster.

Class 336.—*White Orpington Cocks.* [13 entries, 5 absent.]

- 2947 I. (20s.)—W. M. BELL, St. Leonard's Poultry Farm, Ringwood.  
 2951 II. (10s.)—M. LINDNER, White House Poultry Farm, Hanbury, Bromsgrove.  
 2946 III. (5s.)—R. ANTHONY, Home Farm, Euxton, Chorley.  
 2955 E. N. & H. C.—E. W. REYNOLDS, Massey Hall, Skelwall, Warrington.

Class 337.—*White Orpington Hens.* [17 entries, 2 absent.]

- 2980 I. (20s.)—W. M. BELL, St. Leonard's Poultry Farm, Ringwood.  
 2970 II. (10s.)—M. LINDNER, White House Poultry Farm, Hanbury, Bromsgrove.  
 2959 III. (5s.)—R. ANTHONY, Home Farm, Euxton, Chorley.  
 2986 E. N. & H. C.—CAPT. F. GLOVER, Hobberley House, Shadwell, Leeds.

Class 338.—*White Orpington Cockerels.* [9 entries, 1 absent.]

- 2976 I. (20s.)—MRS. FRANK BATEMAN, The Lodge, Shinfield, Reading.  
 2977 II. (10s.)—W. M. BELL, St. Leonard's Poultry Farm, Ringwood.  
 2978 III. (5s.)—W. H. COOK, Model Poultry Farm, St. Paul's Cray.  
 2981 E. N. & H. C.—W. H. MITCHELL, Elmdene, Kenilworth.

Class 339.—*White Orpington Pullets.* [12 entries, 1 absent.]

- 2985 I. (20s.)—R. ANTHONY, Home Farm, Euxton, Chorley.  
 2985 II. (10s.)—F. W. TAYLOR & CO., The Firs, Heronsgate, Rickmansworth.  
 2987 III. (5s.)—W. M. BELL, St. Leonard's Poultry Farm, Ringwood.  
 2996 E. N. & H. C.—JOHN TAYLOR, Heaton Poultry Farm, Heaton.

Class 340.—*Black Orpington Cocks.* [26 entries, 1 absent.]

- 3000 I. (20s.)—W. M. BELL, St. Leonard's Poultry Farm, Ringwood.  
 3002 II. (10s.)—FRANK BLOOMER, Foxcote, Stourbridge.  
 3007 III. (5s.)—W. H. COOK, Model Poultry Farm, St. Paul's Cray.  
 3006 E. N. & H. C.—W. COOK & SONS, Orpington House, St. Mary Cray.

Class 341.—*Black Orpington Hens.* [16 entries, 1 absent.]

- 3025 I. (20s.)—W. M. BELL, St. Leonard's Poultry Farm, Ringwood.  
 3026 II. (10s.)—FRANK BLOOMER, Foxcote, Stourbridge.  
 3029 III. (5s.)—W. COOK & SONS, Orpington House, St. Mary Cray.  
 3030 E. N. & H. C.—W. H. COOK, Model Poultry Farm, St. Paul's Cray.

Class 342.—*Black Orpington Cockerels.* [8 entries, none absent.]

- 3045 I. (20s.)—LADY ALICE STANLEY, Cowarth Park, Sunningdale.  
 3041 II. (10s.)—W. H. COOK, Model Poultry Farm, St. Paul's Cray.  
 3042 III. (5s.)—JAMES CROCKER, Newark Road, Collingham, Newark.  
 3040 E. N. & H. C.—W. M. BELL, St. Leonard's Poultry Farm, Ringwood.

Class 343.—*Black Orpington Pullets.* [10 entries, none absent.]

- 3049 I. (20s.)—W. H. COOK, Model Poultry Farm, St. Paul's Cray.  
 3054 II. (10s.)—LADY ALICE STANLEY, Cowarth Park, Sunningdale.  
 3052 III. (5s.)—MORLAND HUTCHINSON, The Woodlands, Birkdale, Southport.  
 3051 E. N. & H. C.—A. C. GILBERT, North Bank, St. Mary Cray.

1 Special Prize of 20s. given for the best bird in Classes 310-354.

### Minorcas.

Class 344.—*Minorca Cocks*. [11 entries, 4 absent.]

- 3065 I. (20s.) & 3066 III. (5s.)—SMETHURST & HASLAM, Starkies, Bury.  
 3063 II. (10s.)—ARTHUR GEORGE PITTS, Highbridge, Somerset.  
 3069 E. N. & H. C.—FURSLAND BROS., Bridgwater.

Class 345.—*Minorca Hens*. [18 entries, none absent.]

- 3071 I. (20s.)—J. T. CATHCART, Pitcairrie, Newburgh, Fife.  
 3062 II. (10s.)—SMETHURST & HASLAM, Starkies, Bury.  
 3060 III. (5s.)—ARTHUR GEORGE PITTS, Highbridge, Somerset.  
 3073 E. N. & H. C.—FURSLAND BROS., Bridgwater.

Class 346.—*Minorca Cockerels*. [4 entries.]

- 3089 I. (20s.)—SMETHURST & HASLAM, Starkies, Bury.  
 3086 II. (10s.)—MRS. FRANK BATEMAN, The Lodge, Shinfield, Reading.  
 3088 III. (5s.)—CHARLES PRATT, The Cottage, Skellingthorpe, Lincoln.  
 3087 E. N. & H. C.—THOMAS F. HORSLEY, South Grove, Highgate, N.

Class 347.—*Minorca Pullets*. [4 entries.]

- 3093 I. (20s.)—SMETHURST & HASLAM, Starkies, Bury.  
 3090 II. (10s.)—ALFRED DODD, Lodge Cottage, Shavington, Crewe.  
 3091 III. (5s.), & 3092 E. N. & H. C.—EDGAR A. HOWE, Stoke-by-Nayland, Colchester.

### Leghorns.

Class 348.—*White Leghorn Cocks or Cockerels*. [7 entries, 1 absent.]

- 3099 I. (20s.)—SMETHURST & HASLAM, Starkies, Bury.  
 3087 II. (10s.)—J. READER, Leghorn House, Esrick.  
 3094 III. (5s.)—R. ANTHONY, Home Farm, Euxton, Chorley.  
 3100 E. N. & H. C.—A. STANBURY, Weekaboro Farm, Ippelen, Newton Abbot.

Class 349.—*White Leghorn Hens or Pullets*. [15 entries, 5 absent.]

- 3113 I. (20s.), & 3112 II. (10s.)—SMETHURST & HASLAM, Starkies, Bury.  
 3110 III. (5s.)—J. READER, Leghorn House, Esrick.  
 3115 E. N. & H. C.—HENRY WILLIAMS, Wood Lane End, Hemel Hempstead.

Class 350.—*Black Leghorn Cocks or Cockerels*. [4 entries, 2 absent.]

- 3117 I. (20s.)—MORLAND HUTCHINSON, The Woodlands, Birkdale, Southport.  
 3119 II. (10s.)—F. FRED NICHOLSON, Willoughton Manor, near Lincoln.

Class 351.—*Black Leghorn Hens or Pullets*. [5 entries, 1 absent.]

- 3121 I. (20s.)—JOHN HURST, South Terrace, Glossop.  
 3120 II. (10s.)—MRS. HERBERT BURY, Lomber Hey, High Lane, Cheshire.  
 3124 III. (5s.), & 3123 E. N. & H. C.—GEORGE T. MELBOURN, Chelsea House, Risholme Road, Lincoln.

Class 352.—*Leghorn Cocks or Cockerels, any other colour*. [4 entries.]

- 3125 I. (20s.)—R. ANTHONY, Home Farm, Euxton, Chorley.  
 3128 II. (10s.)—ALBERT WIDD, Leghorn House, Earlestown.  
 3126 III. (5s.)—ROBERT CHIPPINDALE, Hampson Green, Ellel, Lancaster.  
 3127 E. N. & H. C.—GILLING BROS., Lower Milton, Wells.

Class 353.—*Leghorn Hens or Pullets, any other colour*. [3 entries.]

- 3129 I. (20s.)—R. ANTHONY, Home Farm, Euxton, Chorley.  
 3131 II. (10s.)—W. H. FLETCHER, Peak Dale, *via* Buxton.  
 3130 III. (5s.)—ROBERT CHIPPINDALE, Hampson Green, Ellel, Lancaster.

### Andalusians.

Class 354.—*Andalusian Cocks or Cockerels, Hens or Pullets*.

[6 entries, none absent.]

- 3135 I. (20s.), & 3134 III. (5s.)—ROBERT LITTLE, JUN., Rokeby Cottage, Glossop.  
 3132 II. (10s.)—R. ANTHONY, Home Farm, Euxton, Chorley.  
 3136 E. N. & H. C.—G. M. SOAMES, Welton House, Daventry.

### Dorkings.

Class 355.—*Coloured Dorking Cocks*. [9 entries, 1 absent.]

- 3144 I. (20s.)—GEORGE H. PROCTER, Flass House, Durham.  
 3140 II. (10s.)—J. T. CATHCART, Pitcairrie, Newburgh, Fife.  
 3142 III. (5s.)—ARTHUR C. MAJOR, Ditton, Langley.  
 3138 E. N. & H. C.—CHARLES ATKENHEAD, Stud Farm, Seaham Harbour.

**Class 356.—Coloured Dorking Hens.** [6 entries, 1 absent.]

- 3149 I. (20s.)—J. T. CATHCART, Pitcairrie, Newburgh, Fife.  
 3151 II. (10s.)—HERBERT REEVES, Northlands, Emsworth, Hants.  
 3152 III. (5s.)—LADY ALICE STANLEY, Cowarth Park, Sunningdale.  
 3150 R. N. & H. C.—ARTHUR C. MAJOR, Ditton, Langley.

**Class 357.—Coloured Dorking Cockerels.** [7 entries, none absent.]

- 3153 I. (20s.)—J. T. CATHCART, Pitcairrie, Newburgh, Fife.  
 3158 II. (10s.) & 3157 R. N. & H. C.—HERBERT REEVES, Northlands, Emsworth.  
 3156 III. (5s.)—ARTHUR C. MAJOR, Ditton, Langley.

**Class 358.—Coloured Dorking Pullets.** [11 entries, 1 absent.]

- 3162 I. (20s.)—J. T. CATHCART, Pitcairrie, Newburgh, Fife.  
 3168 II. (10s.)—HERBERT REEVES, Northlands, Emsworth.  
 3160 III. (5s.)—CHARLES AITKENHEAD, Stud Farm, Seaham Harbour.  
 3163 R. N. & H. C.—THE COUNTESS OF HOME, The Hirsell, Coldstream.

**Class 359.—Dorking Cocks, any other variety.** [6 entries, none absent.]

- 3172 I. (20s. & R. N. for Special.)—J. T. CATHCART, Pitcairrie, Newburgh, Fife.  
 3175 II. (10s.)—HERBERT REEVES, Northlands, Emsworth.  
 3171 III. (5s.)—CHARLES AITKENHEAD, Stud Farm, Seaham Harbour.  
 3176 R. N. & H. C.—LADY ALICE STANLEY, Cowarth Park, Sunningdale.

**Class 360.—Dorking Hens, any other variety.** [5 entries, none absent.]

- 3179 I. (20s.)—ARTHUR C. MAJOR, Ditton, Langley.  
 3181 II. (10s.)—LADY ALICE STANLEY, Cowarth Park, Sunningdale.  
 3180 III. (5s.)—HERBERT REEVES, Northlands, Emsworth.  
 3178 R. N. & H. C.—MRS. A. L. A. GREAVES, Haversham Fields, Wolverton.

**Class 361.—Dorking Cockerels, any other variety.** [4 entries.]

- 3182 I. (20s.)—J. T. CATHCART, Pitcairrie, Newburgh, Fife.  
 3183 II. (10s.)—ARTHUR C. MAJOR, Ditton, Langley.  
 3184 III. (5s.) & 3185 R. N. & H. C.—HERBERT REEVES, Northlands, Emsworth.

**Class 362.—Dorking Pullets, any other variety.** [6 entries, 1 absent.]

- 3186 I. (20s.)—ARTHUR C. MAJOR, Ditton, Langley.  
 3191 II. (10s.) & 3190 III. (5s.)—HERBERT REEVES, Northlands, Emsworth.  
 3187 R. N. & H. C.—J. T. CATHCART, Pitcairrie, Newburgh, Fife.

## Sussex.

**Class 363.—Sussex Cocks, any variety.** [16 entries, none absent.]

- 3194 I. (20s.)—W. H. COOK, Model Poultry Farm, St. Paul's Cray.  
 3201 II. (10s.)—J. P. HOWARD, Glynde Mill, Glynde, Lewes.  
 3195 III. (5s.)—GEORGE EWSON, Glynde, Lewes.  
 3202 R. N. & H. C.—G. J. LENNY, Hill Side, Four Marks, Medstead, Hants.

**Class 364.—Sussex Hens, any variety.** [12 entries, none absent.]

- 3216 I. (20s.)—MRS. GEORGE TROTTER, Storrington, Pulborough.  
 3208 II. (10s.)—E. W. & J. B. BUNNEY, Barcombe Poultry Farm, Barcombe.  
 3211 III. (5s.)—JOHN HORN, Fairmead, High Beech, Essex.  
 3216 R. N. & H. C.—LORD ROTHSCHILD, Tring Park, Herts.

**Class 365.—Sussex Cockerels, any variety.** [5 entries, none absent.]

- 3220 I. (20s.)—JOHN BAILY & SON, 116 Mount Street, London, W.  
 3221 II. (10s.)—E. W. & J. B. BUNNEY, Barcombe Poultry Farm, Barcombe.  
 3224 III. (5s.)—FRANK A. WALLING, 7 Cavendish Cottages, Eastbourne.  
 3223 R. N. & H. C.—J. P. HOWARD, Glynde Mill, Glynde, Lewes.

**Class 366.—Sussex Pullets, any variety.** [5 entries, none absent.]

- 3226 I. (20s.)—LAURENCE CURRIE, Minley Manor, Farnborough.  
 3228 II. (10s.)—J. P. HOWARD, Glynde Mill, Glynde, Lewes.  
 3227 III. (5s.)—JAMES HEPBURN, Laughton, Sussex.  
 3225 R. N. & H. C.—E. W. & J. B. BUNNEY, Barcombe Poultry Farm, Barcombe.

## Brahmas and Cochins.

**Class 367.—Brahma Cocks or Cockerels.** [7 entries, 1 absent.]

- 3230 I. (20s.)—H. BONNY, Marton Poultry Yards, Blackpool.  
 3233 II. (10s.)—R. H. LINGWOOD, Riverside Poultry Yards, Needham Market.  
 3236 III. (5s.)—JAMES LORD, Underbank, Thornton-le-Fyde.  
 3234 R. N. & H. C.—JOHN MARTIN LONGE, Chillesford Lodge, Orford.

<sup>1</sup> Special Prize of 20s. given for the best bird in Classes 356-374.

**Class 368.—Brahma Hens or Pullets.** [10 entries, 3 absent.]

- 3244 I. (20s.)—JOHN MARTIN LONGE, Chillesford Lodge, Orford.  
 3246 II. (10s.)—HERBERT SPENSLEY, Oaks Farm, Menston, Leeds.  
 3238 III. (5s.)—HERBERT FARMER, Midland Poultry Farm, Ranskill, Bewtry.  
 3243 R. N. & H. C.—ROBERT H. LINGWOOD, Riverside Poultry Yards, Needham Market.

**Class 369.—Cochin Cocks or Cockerels.** [17 entries, none absent.]

- 3257 I. (20s. & Special<sup>1</sup>), & 3258 R. N. & H. C.—G. H. PROCTER, Flass House, Durham.  
 3248 II. (10s.)—SIDNEY J. BALLARD, The Pagnella, Park Avenue, Chelmsford.  
 3260 III. (5s.)—ROBERT S. WILLIAMSON, The Grange, Hednesford.

**Class 370.—Cochin Hens or Pullets.** [7 entries, none absent.]

- 3269 I. (20s.), & 3270 III. (5s.)—GEORGE H. PROCTER, Flass House, Durham.  
 3264 II. (10s.)—HERBERT C. BIRDSEY, Boughton Grange, Northampton.  
 3267 R. N. & H. C.—J. B. GILBERT, Ham Court, Charlton Kings, Cheltenham.

## French.

**Class 371.—Faverolle Cocks or Cockerels.** [9 entries, 1 absent.]

- 3272 I. (20s.)—C. H. BRADLEY, Driver's Farm, Tibberton.  
 3273 II. (10s.)—LADY EVELYN COTTERELL, Garnons, Herefordshire.  
 3278 III. (5s.)—FRANK HARGREAVES, Merton Grange, Gamlingay.  
 3271 R. N. & H. C.—G. BETTS, Goostrey, Holmes Chapel.

**Class 372.—Faverolle Hens or Pullets.** [9 entries, 3 absent.]

- 3282 I. (20s.)—C. H. BRADLEY, Driver's Farm, Tibberton.  
 3280 II. (10s.)—G. BETTS, Rose Bank Poultry Farm, Goostrey, Holmes Chapel.  
 3287 III. (5s.)—FRANK HARGREAVES, Merton Grange, Gamlingay.  
 3284 R. N. & H. C.—LADY EVELYN COTTERELL, Garnons, Herefordshire.

**Class 373.—French Cocks or Cockerels, any other variety.** [3 entries, 1 absent.]

- 3291 I. (20s.)—MESDAMES HILL AND MACONCHIE, Tovil House, Maidstone.  
 3290 II. (10s.)—HENRY EDYE, South Binns, Heathfield.

**Class 374.—French Hens or Pullets, any other variety.** [2 entries.]

- 3293 I. (20s.)—MESDAMES HILL AND MACONCHIE, Tovil House, Maidstone.  
 3292 II. (10s.)—ABBOT BROS., Thuxton, Norfolk.

## Table Fowls.

**Class 375.—Pairs of Cockerels or Pullets, pure-breed.** [6 entries, none absent.]

- 3298 I. (20s.)—HERBERT REEVES, Northlands, Emsworth.  
 3296 II. (10s.)—HARRY S. HASSALL, The Cedars, Ashby-de-la-Zouch.  
 3295 III. (5s.)—MRS. J. R. EASBY, Mansfield Farm, Thornaby-on-Tees.  
 3299 R. N. & H. C.—MRS. BRUCE WARD, Westwood, Droitwich.

**Class 376.—Pairs of Cockerels or Pullets, cross-breed.** [10 entries, 1 absent.]

- 3303 I. (20s.)—THE COUNTESS OF HOME, The Hirsell, Coldstream. (Game and Dorking.)  
 3308 II. (10s.)—MISS SEDGWICK, The Firs, Copse Hill, Wimbledon. (Faverolle and Buff Orpington.)  
 3304 III. (5s.)—MRS. T. H. NELSON, Staniwells, Sturton-by-Seawby, Lincoln. (Dorking and Faverolle.)  
 3309 R. N. & H. C.—MRS. BRUCE WARD, Westwood, Droitwich. (Dorking and Buff.)

## DUCKS.

### Aylesbury.

**Class 377.—Aylesbury Drakes or Young Drakes.** [9 entries, 1 absent.]

- 3313 I. (20s.), & 3312 III. (5s.)—THE COUNTESS OF HOME, The Hirsell, Coldstream.  
 3317 II. (10s.)—RUSSELL SHIPLEY, Bishopston, Bristol.  
 3316 R. N. & H. C.—C. RODWELL, Sunny Side, Walton Grove, Aylesbury.

**Class 378.—Aylesbury Ducks or Ducklings.** [8 entries, none absent.]

- 3320 I. (20s.)—THE COUNTESS OF HOME, The Hirsell, Coldstream.  
 3325 II. (10s.)—FREDERICK READ, Aston Clinton, Tring.  
 3324 III. (5s.)—JAMES LONGSON & SONS, Buxton Road, Chapel-en-le-Frith.  
 3320 R. N. & H. C.—E. E. DUCKERING, Station Road, Kirton Lindsey.

<sup>1</sup> Special Prize of 20s. given for the best bird in Classes 365-374.

**Rouen.**

**Class 379.—Rouen Drakes or Young Drakes.** [5 entries, none absent.]

- 3328 I. (20s.)—THE COUNTESS OF HOME, The Hirscl, Coldstream.  
 3327 II. (10s.)—WILLIAM BYGOTT, Ryehill House, Ulceby.  
 3330 III. (5s.), & 3329 E. N. & H. C.—A. T. & H. PEARS, Mere, Lincoln.

**Class 380.—Rouen Ducks or Ducklings.** [4 entries.]

- 3333 I. (20s.)—THE COUNTESS OF HOME, The Hirscl, Coldstream.  
 3332 II. (10s.)—WILLIAM BYGOTT, Ryehill House, Ulceby.  
 3335 III. (5s.)—R. S. WILLIAMSON, The Grange, Hednesford, Staffs.  
 3334 E. N. & H. C.—A. T. & H. PEARS, Mere, Lincoln.

**Indian Runners.**

**Class 381.—Indian Runner Drakes or Young Drakes.** [6 entries, 1 absent.]

- 3339 I. (20s.), & 3340 II. (10s.)—WILLIAM G. KINGWELL, Great Aish, South Brent, Devon.  
 3341 III. (5s.)—RICHARD STUART, Brook Vale, Sowerby, Garstang.  
 3336 E. N. & H. C.—J. DONALD, JUN., Arlosh House, Wigton.

**Class 382.—Indian Runner Ducks or Ducklings.** [6 entries, none absent.]

- 3344 I. (20s.), & 3343 II. (10s.)—WILLIAM G. KINGWELL, Great Aish, South Brent, Devon.  
 3347 III. (5s.)—J. W. WALTON, 22 High Street, Tow Law, Co. Durham.  
 3346 E. N. & H. C.—RICHARD STUART, Brook Vale, Sowerby, Garstang.

**Any Other Breed.**

**Class 383.—Drakes or Young Drakes, any other variety.**

[6 entries, none absent.]

- 3348 I. (20s.)—R. ANTHONY, Home Farm, Euxton, Chorley.  
 3349 II. (10s.)—R. C. P. BRADSHAW, Tinwell, Stamford.  
 3351 III. (5s.)—RUSSELL SHIPLEY, Bishopston, Bristol.  
 3353 E. N. & H. C.—MISS GLADYS S. F. WILSON, Sandridge Park, Totnes.

**Class 384.—Ducks or Ducklings, any other variety.** [5 entries, none absent.]

- 3356 I. (20s.)—RUSSELL SHIPLEY, Bishopston, Bristol.  
 3358 II. (10s.)—MISS GLADYS S. F. WILSON, Sandridge Park, Totnes.  
 3354 III. (5s.)—R. C. P. BRADSHAW, Tinwell, Stamford.  
 3357 E. N. & H. C.—ROBERT S. WILLIAMSON, The Grange, Hednesford.

**Geese.**

**Class 385.—Ganders.** [7 entries, 2 absent.]

- 3362 I. (30s.)—MISS CAMPAIN, Deeping St. Nicholas, Spalding.  
 3361 II. (20s.)—WILLIAM BYGOTT, Ryehill House, Ulceby.  
 3364 III. (10s.)—W. WOODS, Worksop, Notts.  
 3366 E. N. & H. C.—ABBOT BROS., Thuxton, Norfolk.

**Class 386.—Geese.** [9 entries, 2 absent.]

- 3366 I. (30s.)—ABBOT BROS., Thuxton, Norfolk.  
 3368 II. (20s.)—WILLIAM BYGOTT, Ryehill House, Ulceby.  
 3370 III. (10s.)—MISS CAMPAIN, Deeping St. Nicholas, Spalding.  
 3374 E. N. & H. C.—W. WOODS, Worksop, Notts.

**Turkeys.**

**Class 387.—Turkey Cocks.** [15 entries, 1 absent.]

- 3387 I. (30s.)—LORD ROTHSCHILD, Tring Park, Herts.  
 3384 II. (20s.)—WILLIAM F. JOHNSON, Rushbury, Church Stretton.  
 3375 III. (10s.)—ABBOT BROS., Thuxton, Norfolk.  
 3377 E. N. & H. C.—MISS CLARA BINGHAM, Willingham, Gainsborough.

**Class 388.—Turkey Hens.** [12 entries, 3 absent.]

- 3391 I. (30s.)—ABBOT BROS., Thuxton, Norfolk.  
 3386 II. (20s.)—EDWARD KENDRICK, Weeford House, Weeford, Lichfield.  
 3389 III. (10s.)—LORD ROTHSCHILD, Tring Park, Herts.  
 3393 E. N. & H. C.—MISS CLARA BINGHAM, Willingham, Gainsborough.

## FARM AND DAIRY PRODUCE OF THE UNITED KINGDOM.

### Butter.

**Class 389.**—*Bores of Twelve 2-lb. Rolls of Butter, made with not more than 1 per cent. of salt.* [7 entries, 3 absent.]

- 3408 I. (£4.)—SOLOHEAD CO-OPERATIVE AGRICULTURAL AND DAIRY SOCIETY, LTD., Limerick Junction.  
 3407 II. (£2.)—MISS MABEL G. PRIDEAUX, The Grange, Motcombe, Dorset.  
 3406 III. (£1.)—LECKPATRICK CO-OPERATIVE AGRICULTURAL AND DAIRY SOCIETY, LTD., Artigarvan, Strabane.  
 3404 R. N. & H. C.—F. J. B. GUBBINS, Kilfrush, Knocklong, Co. Limerick.

**Class 390.**—*Two Pounds Fresh Butter, slightly salted, made up in Pounds.* [61 entries, 3 absent.]

- 3438 (£2.)—MRS. EMILY LEWIS, Pontantwn Farm, Llangendeirne, Carmarthenshire.  
 3452 (£2.)—LORD ROTHSCILD, Tring Park, Herts.  
 3459 (£2.)—MRS. MINNIE STOKES, Heddon House Dairy, Wylam-on-Tyne.  
 3463 (£2.)—ROLAND UNDERWOOD, Little Gaddesden, Great Berkhamstead.  
 3426 (£1.)—JOHN GRETTON, Stapleford Park, Melton Mowbray.  
 3445 (£1.)—MISS F. PALMER, Bolham Farm, Retford, Notts.  
 3451 (£1.)—WILLIAM RENNIE, Parkhead, Slamannan, Stirlingshire.  
 3458 (£1.)—ARTHUR F. SOMERVILLE, Dinder House, Wells, Somerset.  
 3448 (10s.)—MRS. E. DICKSON PARK, Sedgmoor, Loudwater, Bucks.  
 3455 (10s.)—GEORGE MURRAY SMITH, Gumley Hall, Market Harborough.  
 3468 (10s.)—MRS. FRANK WARD, Burnville, Brenton, Tavistock.  
 3469 (10s.)—MISS M. WYLES, Bassingfield, Nottingham.  
 3449 R. N. & H. C.—THE HON. MRS. PORTMAN, Hestercombe, Taunton.

### Cheese.

Made in 1907.

**Class 391.**—*Three Cheddar Cheeses, of not less than 50 lb. each.* [10 entries, 1 absent.]

- 3478 I. (£5.)—ROBERT STEVENSON, Boghead, Galston, Ayrshire.  
 3477 II. (£3.)—W. C. SPENCER, Hellings Farm, Crewkerne, Somerset.  
 3476 III. (£2.)—N. J. SIMS, Pitcombe, Bruton, Somerset.  
 3479 IV. (£1.)—HARRY TRAVERS, Middle Farm, Sutton, Ditchat, Bath.  
 3475 R. N. & H. C.—HERBERT PICKFORD, Westlands Farm, Melksham.

**Class 392.**—*Three Cheshire Cheeses, of not less than 40 lb. each.* [24 entries, 2 absent.]

- 3497 I. (£5.)—CHARLES PRICE, Ouston Farm, Tetchill, Ellesmere.  
 3494 II. (£3.)—WILLIAM MOORE, Checkley, near Nantwich.  
 3490 III. (£2.)—JOHN ALWOOD, Black Park, Whitchurch, Salop.  
 3502 IV. (£1.)—MRS. M. WALLEY, Frankton, Oswestry, Salop.  
 3500 R. N. & H. C.—MRS. ELLEN SUMNER, Moat Farm, Whitmore, Newcastle, Staffs.

**Class 393.**—*Three Stilton Cheeses.* [15 entries, none absent.]

- 3509 I. (£4.)—J. W. MILLER, The Beech Farm, Shelford, Notts.  
 3510 II. (£3.)—MILLER & MILLER, The Dairy, Plungar, Bottesford, Notts.  
 3517 III. (£1.)—HERBERT B. WILFORD, Long Clawson, Melton Mowbray.  
 3511 R. N. & H. C.—HENRY MORRIS, Manor Farm, Saxelby, Melton Mowbray.

**Class 394.**—*Three Wensleydale Cheeses (Stilton Shape).* [18 entries, 1 absent.]

- 521 I. (£4.)—MRS. MARY HOLLIDAY, Wood End Farm, Streatlam, Darlington.  
 528 II. (£3.)—JOHN STUBBS, Swinethwaite, Leyburn.  
 530 III. (£1.)—WENSLEYDALE PURE MILK SOCIETY, LTD., The Dairy, Northallerton.  
 529 R. N. & H. C.—C. W. WALKER-TINDALE, Northallerton.

**Class 395.**—*Three Double Gloucester Cheeses.* [8 entries, none absent.]

- 533 I. (£4.)—J. C. GREEN, Berkley Farm, Kilmington, Bath.  
 535 II. (£3.)—HISCOCK & CO., Stourton Farm, Stourton, Bath.  
 537 III. (£1.)—THOMAS KENT, Overton Farm, Tean, Stoke-on-Trent.  
 536 R. N. & H. C.—IVON BROOK DAIRY CO., Ivon Brook Grange, Wirksworth.

**Class 396.**—*Three Cheddar Truckle Cheeses.* [12 entries, 1 absent.]

- 542 I. (£3.)—J. C. GREEN, Berkley Farm, Kilmington, Bath.  
 545 II. (£2.)—HISCOCK & CO., Stourton Farm, Stourton, Bath.  
 541 III. (£1.)—J. CANDY, Temple House Farm, Doulling, Shepton Mallet.  
 540 R. N. & H. C.—J. E. ASHBY, Spiers Piece Farm, Steeple Ashton.



## Cider and Perry.

*N.B.*—The names of the Fruits from which the Cider or Perry is stated by the Exhibitor to have been made are added after the address of the Exhibitor. In Classes 399 and 400 the date of making is also given.

**Class 397.**—*Casks of Cider, of not less than 18, and not more than 30 gallons, made in the autumn of 1906.* [11 entries, 1 absent.]

3560 I. (£5.)—TILLEY BROS., East Compton, Shepton Mallet. (Red Jersey, Kingston Black, and New Cadbury.)

3561 II. (£3.)—TILLEY BROS. (Royal Jersey, Cap of Liberty, and Horner.)

3565 III. (£2.)—HERBERT J. DAVIS, Sutton Montis, Sparkford, Somerset. (Yarlington Mill, Harry Masters, White Jersey, and Cap of Liberty.)

3564 R. H. & H. C.—HERBERT J. DAVIS. (Royal and White Jersey and Cap of Liberty.)

**Class 398.**—*One Dozen Bottles of Cider, made in the autumn of 1906.*

[23 entries, none absent.]

3564 I. (£5.)—H. WHITEWAY & CO., LTD., The Orchards, Whimble, Devon. (Sweet Alfred.)

3574 II. (£3.)—R. H. RIDLER & SON, Clehonger Manor, Hereford. (Mixed Fruit.)

3577 III. (£2.)—JAMES SLATTER & CO., Paxford, Campden, Glos. (Kingston Black.)

3565 R. H. & H. C.—JOHN BAZLEY, The Bury, Stoke Prior, Leominster. (Mixed Fruit.)

**Class 399.**—*One Dozen Bottles of Cider, made in any year before 1906.*

[15 entries, none absent.]

3600 I. (£5.)—F. F. WOODWARD & CO., Pershore. (White Bittersweet, 1905.)

3560 II. (£3.)—EARDISTON FARMING CO., LTD., Stockton, Worcester. (White and Italy, Bittersweet and Princess Pippin, 1905.)

3587 III. (£2.)—JOHN BAZLEY, The Bury, Stoke Prior, Leominster. (Fox Whelp, White Norman, and Wilding, 1903.)

3593 R. H. & H. C.—JAMES SLATTER & CO., Paxford, Campden, Glos.

**Class 400.**—*One Dozen Bottles of Perry.* [9 entries, none absent.]

3609 I. (£5.)—F. F. WOODWARD & CO., Pershore. (Barland, 1905.)

3606 II. (£3.)—THOMAS SHIPP, Old Hurst, Slymbridge, Glos. (Oldfield, 1906.)

3602 III. (£2.)—EARDISTON FARMING CO., LTD., Stockton, Worcester. (Oldfield, 1905.)

3605 R. H. & H. C.—ALBERT KNIGHT, Deep Filling Farm, Huntley, Glos.

## Wool.

*Of 1907 Clip.*

**Class 401.**—*Three Fleeces of Leicester or Border Leicester Wool.*

[6 entries, none absent.]

3611 I. (£3), 3610 II. (£2), & 3612 III. (£1.)—GEORGE HARRISON, Gainford Hall, Darlington. (Leicester Yearling Hogs.)

**Class 402.**—*Three Fleeces of Lincoln Wool.* [10 entries, 1 absent.]

3619 I. (£4.1) —C. E. HOWARD, Nocton Rise, Lincoln. (Hogs.)

3618 II. (£3.)—HENRY DUDDING, Biby Grove, Great Grimby. (Hogs.)

3624 III. (£2.)—W. B. SWALLOW, Wootton Lawn, Ulceby. (Yearling Hogs.)

3623 IV. (£1.)—THOMAS SPINK, Hunmanby, York. (Ewe Hogs.)

**Class 403.**—*Three Fleeces of Kent or Romney Marsh Wool.*

[14 entries, none absent.]

3638 I. (£3.)—HENRY RIGDEN, Etchinghill, Lyminge, Kent. (Yearling Ewes.)

3630 II. (£2.)—ARTHUR FINN, Westbroke House, Lydd, Kent.

3631 III. (£1.)—E. & B. KELSEY, Wickham Court, Dover. (Yearling Sheep.)

**Class 404.**—*Three Fleeces of any other Long Wool.* [10 entries, 1 absent.]

3641 I. (£3.)—LORD HENRY BENTINCK, Underley Hall, Kirkby Lonsdale. (Wensleydale Hogs.)

3649 II. (£2.)—THE EXORS. OF THE LATE T. WILLIS, Manor House, Carperby, Yorks. (Wensleydale Hogs.)

3644 III. (£1.)—RUSSELL SWANWICK, Royal Agricultural College Farm, Cirencester. (Cotswold Yearling Sheep.)

**Class 405.**—*Three Fleeces of Southdown Wool.* [4 entries, none absent.]

3653 I. (£3), & 3652 II. (£2.)—WILLIAM DOCKERAY, Park House, Westwell, Ashford, Kent. (Ewes.)

3650 III. (£1.)—LORD CALTHORPE, Elvetham Park, Winchfield. (Yearling Tegs.)

1 First Prize given by the Lincolnshire Agricultural Society.

**Class 406.—Three Fleeces of Shropshire Wool.** [2 entries.]

3655 I. (£3), &amp; 3654 II. (£2)—RICHARD BACH, White House, Onibury, Shropshire. (Yearling Ewes.)

**Class 407.—Three Fleeces of any other Short Wool.** [11 entries, none absent.]3660 I. (£3).—W. R. FLOWER, West Stafford, Dorchester. (Dorset Horn Yearling Ewea.)  
3661 II. (£2).—E. A. HAMBRO, Delcombe Farm, Milton Abbey, Blandford. (Dorset Horn Yearling Hogs.)

3666 III. (£1).—H. W. TAYLOR, Showle Court, Ledbury. (Ryeland Yearling Hogs.)

**Class 408.—Three Fleeces of Welsh Wool.** [6 entries, none absent.]

3668 I. (£3).—W. CONWY BELL, Brynyffynon, Rhuddlan. (Hogs.)

3669 II. (£2).—HENRY O. ELLIS, Tynhendrea, Bangor. (Ewea.)

3671 III. (£1).—ROBERT E. JONES, Hafod, Corwen. (Yearling Sheep.)

**Class 409.—Three Fleeces of Cheviot Wool.** [8 entries, 1 absent.]

3674 I. (£3).—ROBERT GRAHAM, Auchengassel, Twynholm. (Hogs.)

3677 II. (£2).—JACOB ROBSON, Byrness, Otterburn. (Yearling Hogs.)

3675 III. (£1).—G. G. REA, Middleton, Wooler. (Shearling Ewe Hogs.)

**Class 410.—Three Fleeces of Scotch Wool.** [7 entries, 1 absent.]

3681 I. (£3).—JOHN DARGUE, Burnside Hall, Kendal. (Yearling Ewea.)

3684 II. (£2).—JOHN DOWSON, Danby Castle, Gosmont, York. (Hogs.)

3687 III. (£1).—JOHN ROBSON, Newton, Bellingham. (Ewea.)

---

---

## HIVES, HONEY, AND BEE APPLIANCES.<sup>1</sup>

**Class 411.—Collections of Hives and Appliances.** [4 entries.]

3688 I. (£4).—ABBOTT BROS., Southall, Middlesex.

3690 II. (£2).—W. P. MEADOWS, Syston, Leicester.

3691 III. (£1).—E. H. TAYLOR, Welwyn, Herts.

**Class 412.—Frame Hives, for general use, unpainted.** [7 entries.]

3692 I. (20s.), &amp; 3693 III. (10s.).—ABBOTT BROS., Southall, Middlesex.

3695 II. (15s.).—JAMES LEE &amp; SON, 4 Martineau Road, Highbury, N.

**Class 413.—Frame Hives, for Cottager's use, unpainted.** [6 entries.]

3702 I. (20s.).—JAMES LEE &amp; SON, 4 Martineau Road, Highbury, N.

3700 II. (15s.).—ABBOTT BROS., Southall, Middlesex.

3703 III. (10s.).—W. P. MEADOWS, Syston, Leicester.

**Class 414.—Honey Extractor.<sup>2</sup>** [5 entries.]

3706 I. (15s.), 3707 II. (10s.), &amp; 3708 Certificate of Merit.—W. P. MEADOWS, Syston.

**Class 415.—Observatory Hives, not exceeding three Frames, with Bees and Queen.** [6 entries.]

3711 I. (20s.).—WILLIAM DIXON, 5 Beckett Street, Leeds.

3710 II. (15s.).—ABBOTT BROS., Southall, Middlesex.

**Class 416.—Any appliance connected with Bee-keeping, to which no prize has been awarded at a Show of the R.A.S.E.** [9 entries.]

3721 I. (10s.).—W. P. MEADOWS, Syston, Leicester.

3724 Certificate of Merit.—F. W. L. SLADEN, Ripple Court Apiary, near Dover.

3716 Certificate of Merit.—ABBOTT BROS., Southall, Middlesex.

**Class 417.—Comb Honey.<sup>3</sup>** [24 entries.]

3746 II. (15s.).—A. W. WEATHERHOGG, Willoughton, Lincoln.

3729 III. (10s.).—T. S. HOLDSWORTH, Woodford House, Kirton-in-Lindsey.

**Class 418.—Run or Extracted Honey.** [39 entries.]

3753 I. (20s.).—W. J. COOK, Binbrook, Market Rasen.

3761 II. (15s.).—T. S. HOLDSWORTH, Woodford House, Kirton-in-Lindsey.

3759 III. (10s.).—F. HARRIS, High Ferry, Sibsey, Boston.

3766 IV. (5s.).—C. LAYWOOD, Willingham Road, Market Rasen.

3771 E. N. &amp; H. C.—W. PATCHETT, North Wold Apiary, Cabourne, Caistor.

<sup>1</sup> Prizes given by the British Bee-keepers' Association.<sup>2</sup> Prizes given by Mr. T. W. Cowan.<sup>3</sup> Entries in Classes 417 and 418 confined to Members of the Lincolnshire Bee-Keeping Association and residents in the county of Lincoln.

**Class 419.—Comb Honey.**<sup>1</sup> [14 entries.]

- 3793 I. (20s.)—J. G. NICHOLSON, Langwathby, Cumberland.  
 3795 II. (15s.)—JAMES PEARMAN, Penny Long Lane, Derby.  
 3791 III. (10s.)—C. H. HAYNES, Hanley Castle, Worcester.

**Class 420.—Run or Extracted Light-coloured Honey.** [23 entries.]

- 3808 I. (20s.)—H. DILWORTH, Shangton, Kibworth, Leicester.  
 3824 II. (15s.)—JOHN T. WILLSON, York Villas, Shirebrook, Mansfield.  
 3814 III. (10s.)—T. S. HOLDSWORTH, Woodford House, Kirton-in-Lindsey.  
 3818 R. N. & H. C.—W. PATCHETT, North Wold Apiary, Cabourne, Caistor.

**Class 421.—Run or Extracted Medium or Dark-coloured Honey.** [19 entries.]

- 3829 I. (20s.)—H. DILWORTH, Shangton, Kibworth, Leicester.  
 3835 II. (15s.)—GEORGE MARSHALL, Norwell, near Newark.  
 3831 III. (10s.)—F. W. FRUSHER, Swiss Apiary, Crowland, Lincs.  
 3833 R. N. & H. C.—T. S. HOLDSWORTH, Woodford House, Kirton-in-Lindsey.

**Class 422.—Granulated Honey.** [17 entries.]

- 3847 I. (20s.)—H. DILWORTH, Shangton, Kibworth, Leicester.  
 3860 II. (15s.)—JOHN T. WILLSON, York Villas, Shirebrook, Mansfield.  
 3850 III. (10s.)—T. S. HOLDSWORTH, Woodford House, Kirton-in-Lindsey.  
 3856 R. N. & H. C.—R. MORGAN, The Apiary, Cowbridge.

**Class 423.—Comb Honey.**<sup>2</sup> [11 entries.]

- 3868 I. (20s.)—CHARLES LODGE, High Easter, Chelmsford.  
 3864 II. (15s.)—G. HILLS, Moor Barns Apiary, Coton, Cambs.  
 3871 III. (10s.)—W. WOODLEY, Beedon, Newbury.  
 3861 R. N. & H. C.—ALFRED BARBER, South Street, Comberton, Cambs.

**Class 424.—Run or Extracted Light-coloured Honey.** [11 entries.]

- 3875 I. (20s.)—RICHARD BROWN, Flora Apiary, Somersham, Hunts.  
 3879 II. (15s.)—JAMES LEE & SON, 4 Martineau Road, Highbury, N.  
 3882 III. (10s.)—E. C. R. WHITE, Newton Toney, Salisbury.  
 3881 R. N. & H. C.—CHARLES LODGE, High Easter, Chelmsford.

**Class 425.—Run or Extracted Medium or Dark-coloured Honey.** [9 entries.]

- 3890 I. (20s.) & 3891 R. N. & H. C.—E. C. R. WHITE, Newton Toney, Salisbury.  
 3897 II. (15s.)—S. G. S. LEIGH, Broughton, Hants.  
 3888 III. (10s.)—CHARLES LODGE, High Easter, Chelmsford.

**Class 426.—Granulated Honey.** [12 entries.]

- 3898 I. (20s.)—JAMES LEE & SON, 4 Martineau Road, Highbury, N.  
 3899 II. (15s.)—CHARLES LODGE, High Easter, Chelmsford.  
 3896 III. (10s.)—F. R. FORD, County Apiary, Burwell, Cambs.  
 3903 R. N. & H. C.—W. WOODLEY, Beedon, Newbury.

**Class 427.—Frames of Comb Honey, for Extracting.** [12 entries.]

- 3910 I. (20s.)—CHARLES LODGE, High Easter, Chelmsford.

**Class 428.—Heather Honey.** [11 entries.]

- 3923 I. (20s.)—W. SPROSTON, Shugborough, Great Haywood, Staffs.  
 3920 II. (15s.)—BURN & BOTHAM, Phoenix House, Whitby.  
 3916 III. (10s.)—D. W. BARNES, Silver Bank, Coniston, R.S.O., Lancs.  
 3917 R. N. & H. C.—JOHN BERRY, The Apiary, Llanrwst, North Wales.

**Class 429.—Heather Mixture Extracted Honey.** [11 entries.]

- 3929 I. (20s.)—W. E. BROOKING, Malborough, Kingsbridge, Devon.  
 3934 II. (15s.)—JAMES PEARMAN, Penny Long Lane, Derby.  
 3935 III. (10s.)—W. SPROSTON, Shugborough, Great Haywood, Staffs.  
 3936 R. N. & H. C.—F. F. UPTON, 73 Church Street, Rugeley.

**Class 430.—Best and Most Attractive Displays of Honey.** [11 entries.]

- 3945 I. (30s.)—T. S. HOLDSWORTH, Woodford House, Kirton-in-Lindsey.  
 3941 II. (20s.)—RICHARD BROWN, Flora Apiary, Somersham, Hunts.  
 3947 III. (10s.)—JAMES PEARMAN, Penny Long Lane, Derby.  
 3942 R. N. & H. C.—W. DIXON, 5 Beckett Street, Leeds.

<sup>1</sup> Entries in Classes 419-422 limited to residents in Cheshire, Cumberland, Derbyshire, Durham, Herefordshire, Lancashire, Leicestershire, Lincolnshire, Monmouthshire, Northumberland, Nottinghamshire, Rutland, Shropshire, Staffordshire, Warwickshire, Westmorland, Worcester-shire, York-shire, the Isle of Man, Ireland, Scotland, or Wales.

<sup>2</sup> Entries in Classes 423-428 limited to residents in Bedfordshire, Berkshire, Bucks., Cambridgeshire, Cornwall, Devon, Dorset, Essex, Gloucestershire, Hampshire, Herts., Hunts, Isle of Wight, Kent, Middlesex, Norfolk, Northamptonshire, Oxfordshire, Somerset, Suffolk, Surrey, Sussex, or Wiltshire.

**Class 431.**—*Exhibits of not less than 2 lb. of Wax, the Produce of the Exhibitor's Apiary.* [12 entries.]

- 3969 I. (10s.)—E. C. R. WHITE, Newton Toney, Salisbury.  
 3967 II. (7s. 6d.)—CHARLES LODGE, High Easter, Chelmsford.  
 3963 III. (5s.)—F. W. FRUSHER, Swiss Apiary, Crowland, Linca.

**Class 432.**—*Exhibits of not less than 3 lb. of Wax, the Produce of the Exhibitor's Apiary.* [5 entries.]

- 3964 I. (10s.)—JAMES PEARMAN, Penny Long Lane, Derby.  
 3962 II. (7s. 6d.)—F. HARRIS, High Ferry, Sibley, Boston.  
 3963 III. (5s.)—CHARLES LODGE, High Easter, Chelmsford.

**Class 433.**—*Half-gallons of Honey Vinegar.* [3 entries.]

- 3968 I. (7s. 6d.)—JAMES PEARMAN, Penny Long Lane, Derby.  
 3966 II. (5s.)—W. BALL, Eagle Hall, Lincoln.

**Class 434.**—*Half-gallons of Mead.* [2 entries.]

- 3969 II. (5s.)—RICHARD BROWN, Flora Apiary, Somersham, Hunts.

**Class 435.**—*Exhibits of a practical or interesting nature connected with Bee-culture, not mentioned in the foregoing Classes.* [3 entries.]

- 3972 I. (10s.)—GEORGE ROSE, 50 Great Charlotte Street, Liverpool.  
 3971 Certificate of Merit.—W. DIXON, 5 Beckett Street, Leeds.

## HORSE-SHOEING COMPETITIONS.

**Class 1.**—*Hunters.* [53 entries, 4 absent.]

- 16 I. (£3 10s.)—TOM DRING, R.S.S., Staley Terrace, Byecroft St., Ashton-under-Lyne.  
 1 II. (£3.)—ALFRED BENJAMIN BENNETT, R.S.S., Whittlebury, Towcester.  
 4 III. (£2 10s.)—WILLIAM JOSEPH BROWN, R.S.S., Chapel Brampton, Northampton.  
 10 IV. (£2.)—ELI DEA VILLE, R.S.S., Town House, Hanbury, Burton-on-Trent.  
 8 V. (£1 10s.)—DAVID DAVIES, R.S.S., Peterwell Forge, Lampeter.  
 20 VI. (£1.)—DAVID JONES, R.S.S., Tairderwen Shoeing Forge, Brecon.  
 26 R. N. & H. C.—THOMAS BENJAMIN LEWIS, R.S.S., Cambrian Forge, Aberystwyth.

**Class 2.**—*Cart Horses.* [77 entries, 3 absent.]

- 125 I. (£3 10s.)—J. WALTERS, R.S.S., Penlynraça Forge, Llannon, Llanelltyd.  
 92 II. (£3.)—WILLIAM JONES, R.S.S., Smith Field Forge, Ystradgynlais.  
 103 III. (£2 10s.)—WILLIAM MORGAN, Cwypmer, Llanarthney.  
 89 IV. (£2.)—HARRY JONES, R.S.S., The Forge, St. Arvans, Chepstow.  
 104 V. (£1 10s.)—J. CHARLES MORRIS, R.S.S., High Street Forge, Henley-in-Arden.  
 85 VI. (£1.)—GEORGE IBBOTSON, R.S.S., Redlands Park Road, Caterham.  
 102 R. N. & H. C.—HERBERT MORGAN, Cwypmer, Llanarthney.

## FARM PRIZE COMPETITIONS.

**Class 1.**—*For the best managed arable and grass farms, in the County of Lincoln, exceeding 300 acres.* [41 entries, 3 withdrawn.]

- 13 I. (£60.)—JOHN EVENS, Burton, near Lincoln.  
 37 II. (£30.)—JOHN TODD, Kirkby Green, Lincoln.  
 33 R. N.—WILLIAM SEARBY, Spilsby Road, Horncastle.

**Class 2.**—*For the best managed arable and grass farms in the County of Lincoln, over 50 acres and not exceeding 300 acres.* [49 entries, 2 withdrawn.]

- 98 I. (£35.)—EDWARD JAMES TURBON, Horkstow, Hull.  
 3 II. (£25.)—WILLIAM BRAY, East Keal, Spilsby.  
 2 R. N.—HENRY NEESHAM, Lodge Farm, Canwick.

**Class 3.**—*For the best managed arable and grass farms, regularly hunted over by the Belvoir, Blankney, Brocklesby, Burton, or Southwold Hounds, exceeding 300 acres.* [40 entries, 3 withdrawn.]

- 21 I. (£30.)—WILLIAM SEARBY, Spilsby Road, Horncastle.  
 19 II. (£25.)—JOHN ROBINSON, Eastfield House, North Thoresby, S.O.  
 12 III. (£20.)—HENRY BEMROSE MINTA, Normanton Hill, Grantham.  
 22 R. N.—FRANK GOODSON ALLEN, Metheringham, Lincoln.

**Class 4.**—*For the best managed arable and grass farms, regularly hunted over by the Belvoir, Blankney, Brocklesby, Furton, or Southwold Hounds, over 50 acres and not exceeding 300 acres.* [53 entries, 2 withdrawn.]

- 160 I. (£25.)—HENRY NEESHAM, Lodge Farm, Canwick.  
 135 II. (£20.)—ROBERT CECIL COOPER, Waltham, Melton Mowbray.  
 134 III. (£15.)—EDWARD BURKITT, Faldingworth, near Lincoln.  
 173 IV. (£15.)—LESLIE PHILIP STEPHENSON, South Thoresby, Alford.  
 148 R. N.—C. HENSMAN & SON, Fulletby Grange, Horncastle.

### Forestry Section.

**Class 1.**—*Specimens of Oak, Elm, and Ash Timber, grown in Great Britain or Ireland.*

- 1 I. (Silver Medal.)—THE DUKE OF WELLINGTON, K.G., Strathfield Saye, Mortimer.  
 2 II. (Bronze Medal.)—THE MARQUIS OF EXETER, Burghley House, Stamford.

**Class 2.**—*Specimens of Larch, Spruce, and Scotch Pine Timber.*

- 6 I. (Silver Medal.)—THE EARL OF CARNARVON, Highclere Castle, Newbury.  
 8 II. (Bronze Medal.)—THE EARL OF YARBOROUGH, Brocklesby Park, Lincolnshire.

**Class 3.**—*Specimens of any other sort of Hard Wood or Broad-leaved Timber.*

- 11 I. (Silver Medal.)—THE EARL OF YARBOROUGH, Brocklesby Park, Lincolnshire.

**Class 4.**—*Specimens of any other sort of Coniferous Timber.*

- 14 I. (Silver Medal.)—THE EARL OF YARBOROUGH, Brocklesby Park, Lincolnshire.  
 13 II. (Bronze Medal.)—THE EARL OF CARNARVON, Highclere Castle, Newbury.

**Class 5.**—*Specimens of damage done by Insect Pests injurious to Forest Trees.*

- 18 I. (Silver Medal.)—SOUTH EASTERN AGRICULTURAL COLLEGE, Wye, Kent.  
 17 II. (Bronze Medal.)—A. T. GILLANDERS, Alnwick Castle, Northumberland.

**Class 6.**—*Specimens showing comparative quality of Larch Timber grown on different soils and situations.*

- 19 I. (Silver Medal.)—LORD BURTON, Rangemore, Burton-on-Trent.

**Class 7.**—*Specimens showing the comparative quality of any Timber—other than Larch—grown on different soils and situations.* [No entry.]

**Class 8.**—*Specimens demonstrating the beneficial effects of Pruning.*

- 20 I. (Silver Medal.)—THE DUKE OF NORTHUMBERLAND, K.G., Alnwick Castle.

**Class 9.**—*Specimens of Stems illustrating the effects of dense and thin crops in branch suppression and quality of the timber.*

- 24 I. (Silver Medal.)—THE MARQUIS OF EXETER, Burghley House, Stamford.

**Class 10.**—*Examples of the damage caused by Squirrels, Voles, &c., to various kinds of trees.*

- 27-31 I. (Silver Medal.)—THE EARL OF YARBOROUGH, Brocklesby Park, Lincolnshire.

**Class 11.**—*Gates for Farm or Estate use, manufactured from Oak Timber.*

- 36 I. (Silver Medal.)—THE EARL OF YARBOROUGH, Brocklesby Park, Lincolnshire.  
 33 II. (Bronze Medal.)—THE MARQUIS OF EXETER, Burghley House, Stamford.

**Class 12.**—*Gates for Farm or Estate use, manufactured from any other home-grown wood.*

- 41 I. (Silver Medal.)—THE EARL OF YARBOROUGH, Brocklesby Park, Lincolnshire.  
 38 II. (Bronze Medal.)—THE MARQUIS OF EXETER, Burghley House, Stamford.

**Class 13.**—*Wicket or Hunting Gates (self-closing), manufactured from home-grown timber.*

- 47 I. (Silver Medal.)—THE EARL OF YARBOROUGH, Brocklesby Park, Lincolnshire.

**Class 14.**—*Specimens of Home-grown Timber, suitable for estate purposes, showing the advantage of applying Creosote or any other preservative.*

- 50-53 I. (Silver Medal.)—THE EARL OF YARBOROUGH, Brocklesby Park, Lincolnshire.

### IMPLEMENTS.

**Class 1.**—*Swath Turners.*<sup>1</sup> [11 entries.]

- 3676 I. (£15, & Silver Medal), & 3677 II. (£10, & Bronze Medal).—BLACKSTONE & CO. LTD., Stamford.

<sup>1</sup> The £50 for these Prizes given by the Lincolnshire Agricultural Society.

Class 2.—*Side Delivery Rakes.*<sup>1</sup> [4 entries.]

- 3679 I. (£15, & Silver Medal).—BLACKSTONE & CO., LTD., Stamford.  
 2535 II. (£10, & Bronze Medal).—MARTIN'S CULTIVATOR CO., Stamford.

## Miscellaneous Implements.

Silver Medals for articles entered as "New Implements for Agricultural or Estate Purposes."

390 F. M. DOSSOR, 15 Auckland Road, Doncaster, for Seed Dresser.

LOCAL CLASSES.<sup>2</sup>

Open only to Members of the Lincolnshire Agricultural Society residing or farming in the County of Lincoln.

## CATTLE.

## Shorthorns.

Class 1.—*Shorthorn Bulls, calved before 1905.*

- 6 I. (£5).—ROBERT CHATTERTON, Stenigot, Lincoln, for **Woodhouse Prince**, red, calved May 21, 1904, bred by E. Harwood, Woodhouse; s. Dewston (C.H.B. 80663), d. Ragwort by Raglan (C.H.B. 77552), g.d. by Captain Pansy (C.H.B. 72163).  
 2 II. (£3).—WALTER WARD, Quarrington, Sleaford, for **Ruddington Duke of Roses**, roan, calved June 22, 1904, bred by the late Philo L. Mills, Ruddington; s. Ruddington Premium Duke (C.H.B. 84671), d. Wild Rose by Solferino (C.H.B. 73068), g.d. by Watchfire (C.H.B. 71828).  
 7 III. (£2).—HENRY DUDDING, Riby Grove, Great Grimsby, for **Whitehall Fanatic** (C.H.B. 97871), roan, calved November 21, 1904, bred by W. Parkin-Moore, Whitehall, Cumberland; s. Brilliant Star (C.H.B. 76240), d. Fancy 16th by Emperor (C.H.B. 67008), g.d. by Alpine Monarch (C.H.B. 53899).

Class 2.—*Shorthorn Bulls, calved in 1905.*

- 9 I. (£5).—HENRY DUDDING, Riby Grove, Great Grimsby, for **Moon King 2nd** (C.H.B. 92594), roan, calved Jan. 23, 1905, bred by Colonel Hughes, Nangaredig, Carmarthen; s. Moonlight (C.H.B. 75110), d. Queen Bertha by Cavalier (C.H.B. 72180), g.d. by Lord Chancellor (C.H.B. 57594).  
 8 II. (£3).—HENRY DUDDING, for **Alastair 2nd** (C.H.B. 90632), red and little white, calved Jan. 3, 1905, bred by the Earl of Powis; s. Alastair (C.H.B. 78217), d. Carnation by Jupiter (C.H.B. 72752), g.d. by Premier Magic (C.H.B. 64537).  
 13 III. (£2).—S. E. DEAN & SONS, Dowsby Hall, Bourne, for **Dowsby Imperial Choice**, red, calved Oct. 23, 1905; s. Imperial Favourite (C.H.B. 86233), d. Choice Juliet 2nd by Red Monarch (77905), g.d. by Hindlip Boy (C.H.B. 68755).  
 14 R. N. & H. C.—S. E. DEAN & SONS, for **Imperial Wild Eyes 3rd**.

Class 3.—*Shorthorn Bull Calves, calved in 1906.*

- 21 I. (£5).—HENRY DUDDING, Riby Grove, Great Grimsby, for **Strowan Kaiser**, roan, calved Jan. 5, bred by Captain G. Stirling, Strowan, Crief, N.B.; s. Strowan Champion (C.H.B. 82417), d. Sybil's Bracelet by Prince Dagmar (C.H.B. 79615), g.d. by Frederick the Great (C.H.B. 72562).  
 17 II. (£3).—CAPTAIN J. S. REEVE, Leadenham House, Lincoln, for **Knight of Kesteven**, red, calved May 17; s. Spicy Magnate (C.H.B. 93505), d. Bertha 20th by Sir John (C.H.B. 68062), g.d. by Wild Cambridge (C.H.B. 68061).  
 22 III. (£2).—HENRY DUDDING, for **Strowan Butterfly 2nd**, roan, calved March 16, bred by Captain G. Stirling, Strowan, Crief, N.B.; s. Montrave Baron (C.H.B. 81740), d. Strowan Buttercup 12th by Dauntless 4th (C.H.B. 62309), g.d. by Admiral (C.H.B. 56797).  
 24 R. N. & H. C.—ROBERT CHATTERTON, Stenigot, Lincoln, for **Polmaise Ironclad**.

Class 4.—*Shorthorn Cows or Heifers, in-milk or in-calf, calved before or in 1904.*

- 28 I. (£5).—JOHN EVENS, Burton, Lincoln, for **Burton Quality 3rd** (vol. 10, p. 189), red, calved Feb. 24, 1901; s. Red Rover (C.H.B. 77618), d. Burton Quality by Collingwood (C.H.B. 57074).  
 36 II. (£3).—EDWIN BOURNE, George Street, Louth, for **Ruby 12th**, red, calved May 20, 1902, bred by the late T. B. Freshney, South Somercotes, Louth; s. Benniworth 4th (629), d. Ruby 2nd by Saltfleet Eclipse (227).  
 37 III. (£2).—CAPT. E. M. GRANTHAM, The Rookery, West Keal, Spilsby, for **Keal Nancy**, red, calved March 27, 1903; s. Conbalcom (1831), d. Keal Favourite by Stenigot Red (531).  
 47 R. N. & H. C. HENRY DUDDING, Riby Grove, Great Grimsby, for **Royal Lily**.

<sup>1</sup> The £50 for these Prizes given by the Lincolnshire Agricultural Society.

<sup>2</sup> Prizes given by the Lincolnshire Agricultural Society.

Class 5.—*Shorthorn Heifers, calved in 1905.*

- 53 I. (£5).—S. F. DEAN & SONS, Dowsby Hall, Bourne, for **Starlight**, roan, calved Jan. 15, bred by Lord Lovat; s. Prime Minister (C.H.B. 84355), d. Adeline 4th by Victor of Sittytton (C.H.B. 80171), g.d. by Royal Star (C.H.B. 71102).
- 49 II. (£3).—HENRY DUDDING, Riby Grove, Great Grimby, for **Crystal Empress**, roan, calved Jan. 3, bred by Lord Lilford, Lilford Hall, Oundle; s. Golden Shade (C.H.B. 83611), d. Crystal Queen by Crystal Prince (C.H.B. 70221), g.d. by Duke of Wynyard 3rd (C.H.B. 56648).
- 50 III. (£2).—HENRY DUDDING, for **Waterloo Winnow**, roan, calved April 15, bred by J. D. Fletcher, Rosehaugh, N.B.; s. Master Millicent (C.H.B. 84080), d. Waterloo Winsome by Lord Rose-bank (C.H.B. 77105), g.d. by Watchword (C.H.B. 68063).
- 54 R. N. & H. C.—S. E. DEAN & SONS, Dowsby Hall, Bourne, for **Bessborough Lady 6th**.

Class 6.—*Shorthorn Heifers, calved in 1906.*

- 64 I. (£4).—ROBERT CHATTERTON, Stenigot, Lincoln, for **Staveley Daisy**, roan, calved Jan. 3, bred by Col. the Hon. H. Lawson; s. Farmer's Glory (C.H.B. 80566), d. Daisy Banby Wedlock 8th by Magnate (C.H.B. 74973), g.d. by Bright Banner (C.H.B. 58553).
- 83 II. (£2).—HENRY DUDDING, Riby Grove, Great Grimby, for **Natland Gem**, roan, calved Jan. 17, bred by W. Kendall, Natland Park, Kendal; s. Tom O'Shanter (C.H.B. 90303), d. Lettice by Stanley (C.H.B. 77954), g.d. by Bridegroom (C.H.B. 68269).
- 85 III. (£1).—HENRY DUDDING, for **Newton Jealousy 3rd**, roan, calved Feb. 16, bred by A. M. Gordon, Newton, Insch, N.B.; s. Koh-i-noor (C.H.B. 81409), d. Jealous Girl by Wilkins Micawber (C.H.B. 56768), g.d. by Lord Chelmsford (C.H.B. 54073).
- 80 R. N. & H. C.—S. E. DEAN & SONS, Dowsby Hall, Bourne, for **Dowsby Sea Lady**.

## HORSES.

## Hunters.

Class 7.—*Hunter Mares, with Foals at foot.*

- 98 I. (£5).—W. B. SWALLOW, Wootton Lawn, Ulceby, for **Tugela**, brown, foaled 1900; s. Anklebiter, d. Beatrice.
- 99 II. (£3).—W. B. SWALLOW, for **Countess**, brown, foaled 1895; s. Knight Templar.
- 95 III. (£2).—EDWARD H. T. PULLEINE, The Grange, Owston Ferry, Doncaster, for **Miss Walker**, brown, foaled 1896; s. Escamillo, d. by Haphazard.
- 90 R. N. & H. C.—FREDERICK WARD, Quarrington, Sleaford, for **Camera**.

Class 8.—*Hunter Colt Foals, the produce of Mares in Class 7.*

- 100 I. (£4).—OLIVER QUIBELL, Shalem Lodge, Newark, for foal, foaled March 29; s. Worsthorn, d. Barbe 2nd by Roll Call. [Exhibited with No. 90.]

Class 9.—*Hunter Filly Foals, the produce of Mares in Class 7.*

- 104 I. (£4).—C. W. CROSS, Blyborough, Kirton Lindsey, for brown foal, foaled April 27; s. Lincoln Mint d. Tet. [Exhibited with No. 94.]
- 108 II. (£2).—W. B. SWALLOW, Wootton Lawn, Ulceby, for brown foal, foaled May 5; s. Wales, d. Tugela by Anklebiter, g.d. Beatrice. [Exhibited with No. 98.]
- 105 III. (£1).—EDWARD H. T. PULLEINE, The Grange, Owston Ferry, Doncaster, for **Miss Lily**, brown, foaled 1907; s. Red Eagle, d. Miss Walker by Escamillo, g.d. by Haphazard. [Exhibited with No. 95.]
- 100 R. N. & H. C.—FREDERICK WARD, Quarrington, Sleaford.

Class 10.—*Hunter Geldings or Fillies, foaled in 1906.*

- 110 I. (£5).—W. B. SWALLOW, Wootton Lawn, Ulceby, for **Alphonso**, chestnut gelding; s. Wales, d. Beatrice.
- 116 II. (£3).—CHARLES J. C. HILL, Glentworth Hall, Lincoln, for chestnut filly; s. Travelling Lad, d. by Galloping Lad, out of Craig Leigh.
- 117 III. (£2).—C. W. CROSS, Blyborough, Kirton Lindsey, for chestnut gelding; s. Travelling Lad, d. Tet.
- 111 R. N. & H. C.—OLIVER QUIBELL, Shalem Lodge, Newark, for **Dawn**.

Class 11.—*Hunter Geldings or Fillies, foaled in 1905.*

- 119 I. (£5).—CHARLES J. C. HILL, Glentworth Hall, Lincoln, for bay or brown gelding; s. Travelling Lad, d. by Galloping Lad out of Craig Leigh.
- 120 II. (£3).—EDWARD H. T. PULLEINE, The Grange, Owston Ferry, Doncaster, for **Mason Ott**, bay colt, bred in Ireland; s. Dark Ivy, d. Brosia Lass.
- 125 III. (£2).—W. B. SWALLOW, Wootton Lawn, Ulceby, for **Camillia**, bay filly; s. Caminada, d. Victoria.
- 118 R. N. & H. C.—C. W. CROSS, Blyborough, Kirton Lindsey.

Class 12.—*Hunter Mares or Geldings foaled in 1904.*

- 129 I. (£5).—WILLIAM WOOD, Habrough, for chestnut gelding; s. Damocles, d. by Whitehall, g.d. by Jurmac, g.g.d. St. Margaret by Cathedral.  
 126 II. (£3).—W. B. SWALLOW, Wootton Lawn, Ulceby, for Red Morn, chestnut; s. Red Eagle, d. Beatrice.  
 133 III. (£2).—FREDERICK WARD, Quarrington, Sleaford, for Pioneer; s. El Diablo, d. Nicoletta by Drumhead.

130 R. N. & H. C.—THE EXERCUTRIX OF THE LATE JONAS WEBB.

Class 13.—*Hunter Mares or Geldings, foaled in 1903.*

- 140 I. (£5).—J. G. ELSEY, The Chase, Baumber, Horncastle, for Honeymoon, bay gelding; s. Hindley.  
 145 II. (£3).—A. E. BRADLEY, Rippingale, Bourne, for Black Patch, chestnut gelding; s. Gordon, d. by Astrologer, g.d. Rivett.  
 144 III. (£2).—E. S. TOMLINSON, Rauceby Grange, Grantham, for Top Card II., brown; s. Go Nap, d. Primrose by Strathedess.  
 141 R. N. & H. C.—CHARLES J. C. HILL, Glentworth Hall, Lincoln.

## Shires.

Class 14.—*Shire Mares, with Foals at foot.*

- 146 I. (£5).—S. E. DEAN & SONS, Dowsby Hall, Bourne, for Roxby Starlight 49237, black, foaled 1903, bred by W. Sheardown; s. Sea Dog 18348, d. by Blagdon Warlike 12904.  
 160 II. (£3).—E. A. KIRK, Stewton, Louth, for Stewton Florence 37350, bay, foaled 1900; s. Burston Pride 16574, d. Stewton Metal 24852.  
 157 III. (£2).—F. W. GRIFFIN, Boro' Fen, Peterborough, for Lockinge Parlour Maid 28267, brown, foaled 1898, bred by the late Lord Wantage; s. Dunsmore Combination 17314, d. Barmaid 7410 by Bar None 2388.  
 148 R. N. & H. C.—J. W. DAVY, Great Carlton, Louth, for Smiler.

Class 15.—*Shire Colt Foals, the produce of Mares in Class 14.*

- 170 I. (£4).—F. W. GRIFFIN, Boro' Fen, Peterborough, for black foal, foaled April 17; s. Hendre Conqueror 17385, d. Boro' Parlour Maid 44282. [Exhibited with No. 155.]  
 165 II. (£2).—TOM BOND, Ludborough, Louth, for brown foal, foaled April 12; s. Birdsall Menestrel, d. Society Belle. [Exhibited with No. 147.]  
 167 III. (£1).—WILLIAM SALES & SON, Lissington, Lincoln, for bay foal, four white legs and face, foaled April 1; s. Birdsall Menestrel, d. Silver Ness by Raithby Tommy. [Exhibited with No. 149.]  
 166 R. N. & H. C.—J. W. DAVY, Great Carlton, Louth.

Class 16.—*Shire Filly Foals, the produce of Mares in Class 14.*

- 177 I. (£4).—E. A. KIRK, Stewton, Louth, for bay foal, foaled March 31; s. Birdsall Menestrel 1937, d. Stewton Florence 37350. [Exhibited with No. 160.]  
 173 II. (£2).—F. W. GRIFFIN, Boro' Fen, Peterborough, for bay foal, foaled April 9; s. Lockinge Harold 16779, d. Boro' Gen 31081. [Exhibited with No. 156.]  
 174 III. (£1).—F. W. GRIFFIN, for bay foal, foaled May 8; s. Dunsmore Jameson 17972, d. Lockinge Parlour Maid 28267. [Exhibited with No. 157.]  
 181 R. N. & H. C.—WILLIAM OXLEY, The Priory, Brant Broughton, Newark.

Class 17.—*Shire Fillies, foaled in 1906.*

- 183 I. (£5).—A. ERNEST SMITH, Surfleet, Spalding, for Surfleet Gem, bay, bred by J. Holland; s. Sergeant VI. 16389, d. Flower 39503 by Weston Squire 5578.  
 188 II. (£3).—E. H. CARTWRIGHT, Keddington Grange, Louth, for Willaston Gipsy, black, bred by Peter Allen; s. Tatton Friar 21853, d. Court Primrose 50742.  
 195 III. (£2).—F. W. GRIFFIN, Boro' Fen, Peterborough, for Boro' Forest Queen (vol. 29), bay; s. Lockinge Forest King 18867, d. Birdsall Silver 34839 by Menestrel 14180.  
 194 R. N. & H. C.—A. H. CLARK, Moulton Eaugate, Spalding.

Class 18.—*Shire Fillies, foaled in 1905.*

- 200 I. (£5).—W. F. GLAMIER, Winterton, Doncaster, for Chippenham Cingales 50694, brown, bred by E. W. Headington; s. Celtic, d. Delight.  
 203 II. (£3).—F. & R. CASSWELL, East Dunsby, Spalding, for Lady Ancaster, brown, bred by E. Bull; s. Dunsmore Royal Duke, d. Cathorpe Ereat.  
 202 II. (£2).—T. A. & M. W. OLIVER, Claypole, Newark, for Beathorpe Bonnie Girl, bay, bred by Mr. Roe; s. Four Hundred Boy, d. by Carlton Echo.  
 204 R. N. & H. C.—J. & T. SMITHSON, Southrey, Lincoln, for Southrey Woodbine.

Class 19.—*Shire Entire Colts, foaled in 1906.*

- 201 I. (£5).—SAMUEL LEGGATE, Dogdyke, Lincoln, for Dogdyke Royal Ensign, bay, bred by J. Bower, Thornton House, Frithville, Boston; s. Nailstone Royal Knight 14755, d. Violet by Sergeant VI. 16389.  
 210 II. (£3).—T. A. & M. W. OLIVER, Claypole, Newark, for Bellringer, bay, bred by Mr. Collins; s. Ring O'Bells, d. by Horbling Conqueror.



ADVERTISEMENTS.

**HILL & SMITH**

CATALOGUES & LISTS FREE

BRIERLEY HILL IRONWORKS,  
STAFFORDSHIRE.

IRON TREE GUARDS

SHEEP FOLDING HURDLES

WROUGHT IRON DOG KENNEL RAILING

IRON HAY & GRAIN SHEDS

POULTRY FENCING

WROUGHT IRON ENTRANCE GATES

CONTINUOUS IRON FENCING

UNCLIMBABLE GATES & RAILINGS

WROUGHT IRON FIELD GATES

STRAINED WIRE FENCING

GALVANIZED WIRE NETTING

LONDON,  
118, QUEEN VICTORIA ST. E.C.

Detailed description: This is a highly detailed black and white advertisement for Hill & Smith Ironworks. The central focus is the company name 'HILL & SMITH' in large, bold, serif letters, slanted across the top. Below it, a banner reads 'BRIERLEY HILL IRONWORKS, STAFFORDSHIRE.' The advertisement is filled with various illustrations of their products, each enclosed in a decorative, scroll-like frame. At the top left, 'IRON TREE GUARDS' are shown as tall, lattice-like structures around trees. To the right, 'SHEEP FOLDING HURDLES' are depicted as wooden frames with sheep inside. Below these, there are illustrations of 'WROUGHT IRON DOG KENNEL RAILING' (a fenced-in area with a dog), 'IRON HAY & GRAIN SHEDS' (a long, covered structure), and 'POULTRY FENCING' (a fenced-in area with chickens). In the middle row, 'WROUGHT IRON ENTRANCE GATES' are shown as ornate, double doors with decorative finials. To the left is 'CONTINUOUS IRON FENCING' with a cow behind it, and to the right is 'UNCLIMBABLE GATES & RAILINGS' showing a different style of gate. The bottom row features 'WROUGHT IRON FIELD GATES' (a simple wooden-style gate), 'STRAINED WIRE FENCING' (a wire fence with a sheep), and 'GALVANIZED WIRE NETTING' (a roll of wire mesh). At the very bottom, the company's location is given as 'LONDON, 118, QUEEN VICTORIA ST. E.C.' A small banner at the top right says 'CATALOGUES & LISTS FREE'. The entire advertisement is framed by intricate, decorative scrollwork and patterns.

ADVERTISEMENTS.

OPPOSITE THE BRITISH MUSEUM.

# THACKERAY HOTEL

Great Russell Street, London.

NEAR THE BRITISH MUSEUM.

# KINGSLEY HOTEL

Hart Street, Bloomsbury Square, LONDON.

THESE Temperance Hotels are situated close together in one of the healthiest districts of London. They are very near the British Museum, the Thackeray Hotel being directly opposite and the Kingsley within two minutes' walk of that famous place of interest.

The Hotels are most favourably situated with regard to the Houses of Parliament, Law Courts, Art Galleries, and Theatres. In fact, they are within easy walking distance or short cab-drive of nearly all places of interest frequented by those visiting London. They are almost equi-distant from the great Railways, North, South, East, and West : also the Museum and Holborn Stations of the Electric Railways being so close at hand, bring the Hotels to within 8 or 10 minutes of the City, Royal Exchange, and the Bank of England ; while the Agricultural Hall, South Kensington, Earl's Court, Olympia, etc., can be reached within 15 to 30 minutes.

*Spacious Dining, Drawing, Writing, Reading, Billiard and Smoking Rooms. Perfect Sanitation. Floors Fireproof throughout. Night Porters. Telephone.*

**PASSENGER LIFTS, ELECTRIC LIGHT THROUGHOUT,  
BATHROOMS ON EVERY FLOOR, HEATED THROUGHOUT.**

Bedrooms, including Attendance, from **3s. 6d. to 6s.**  
Inclusive charge for Bedroom, Attendance, Table d'Hôte Breakfast and Dinner,  
from **8s. 6d. to 10s. 6d.** per day.

**Full Tariff and Testimonials on Application.**

Intending visitors are requested to send an intimation, if possible, by post or telegram prior to arrival, that rooms may be reserved.

TELEGRAPHIC ADDRESSES : { KINGSLEY HOTEL. "BOOKCRAFT, LONDON."  
  { THACKERAY HOTEL. "THACKERAY, LONDON."

# STORES FOR THE ENGINE OWNER.

We supply everything required by the MACHINIST, and shall be pleased to send CATALOGUE and lists, with best terms.

**SPECIALY**  
Refined  
**CYLINDER**  
and  
**MACHINE**  
**OILS;**  
also  
**PACKING,**  
**JOINTS,**  
**WASTE, &c.**



**Large**  
**Stocks**  
**Kept.**

**Prompt**  
**Dispatch.**

## MECHANICAL

Ratchet driven  
Sight Feed

## LUBRICATOR



WILCOX  
SEMI-ROTARY WING

## PUMPS

LIFT  
and  
FORCE.



PENBERTHY  
Patent

## INJECTOR

for  
Traction  
Engines  
and all  
kinds of  
Boilers.



Also **PATENT**  
**WIRE-BOUND**  
**WATER LIFTER**

## HOSE

(Non-rubber) (See border).

Is automatic & restarts.

# W. H. WILLCOX & CO., LTD.,

ENGINEERS' STORES, 23, 32, 34, & 36,  
Southwark Street,

LONDON.

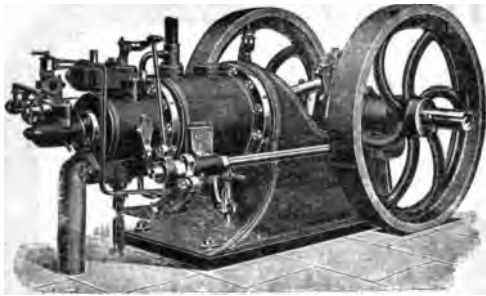

Standard Stationary Oil Engine.

**PRESENT OUTPUT EXCEEDS  
1,000 COMPLETE ENGINES  
PER ANNUM. . . .**

Original Inventors and  
Patentees of . . .

**AUTOMATIC LAMPLESS TUBE  
IGNITION and . . .  
PROPORTIONATE GOVERNING  
for OIL ENGINES. . . .**

**Contractors to  
H.M. Government.**

# PETTER OIL ENGINES



Portable Oil Engine.



Oil Traction Engine.

**1½ to 45 B.H.P.  
STATIONARY,  
PORTABLE,  
and COMBINED with  
PUMPS and DYNAMOS.**

## JAMES B. PETTER AND SONS, Ltd.,

**NAUTILUS WORKS,  
YEOVIL, Eng.**

**SHOWROOMS :**

**73, Queen Victoria  
Street, London, E.C. ;  
140, Victoria Street,  
Bristol.**

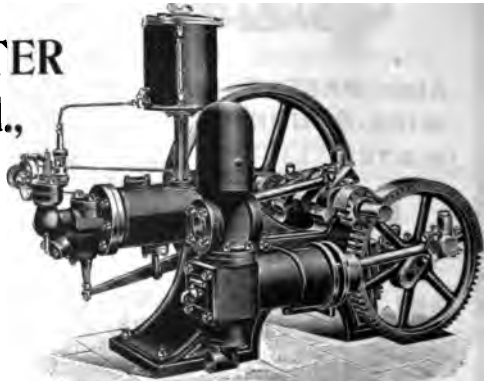

Combined Oil Engine and Pump.

**BIBBY'S  
DAIRY  
CAKE**

*THE MOST  
POPULAR DAIRY  
CAKE IN THE WORLD  
IS  
BIBBY'S*

Manufacturers :  
**J. BIBBY & SONS, LIVERPOOL.**

ADVERTISEMENTS.

# CARSON'S PAINTS

## The Original ANTI-CORROSION PAINT.

The Most Durable and Economical for External Purposes.

## NON-POISONOUS PAINT.

Mixed Ready for Use.

Made in all Colours.

Recommended for Internal and General Work. Far superior to White Lead. Specially suitable for

**STABLES, HORSE BOXES, KENNELS, &c.**

## "MURALINE."

### The Best Washable Water Paint

Sold in a Dry Powder and only requires the addition of cold water to make it ready for use. May be advantageously used as a substitute for Oil Paint on the interiors of

**STABLES, LOOSE BOXES, COACH HOUSES, &c.**

## "VITROLITE."

Manufactured specially for the protection of

### Greenhouses & Horticultural Buildings.

DURABLE. ELASTIC. DOES NOT FLAKE OR SCALE.

Resists Heat, Cold, and Moisture. Dries with an Enamel Surface.

**WHITE & STONE COLOUR, Price 8/6 per Gallon.**

MIXED READY FOR USE.

Price Lists, Pattern Cards and Particulars Post Free.

## WALTER CARSON & SONS,

Telegrams :  
"Carsons, London."

Telephone Nos. :  
69 & 1004 Battersea.

Grove Works, BATTERSEA, LONDON.

Irish Depot—BACHELORS WALK, DUBLIN.

Jan  
20

2  
163

THE JOURNAL  
OF THE  
ROYAL AGRICULTURAL SOCIETY OF ENGLAND.

VOL. 68.

1907.





THE  
JOURNAL  
OF THE  
ROYAL AGRICULTURAL SOCIETY  
OF ENGLAND.

VOLUME 68.

(BEING THE SIXTY-EIGHTH VOLUME ISSUED SINCE THE  
FIRST PUBLICATION OF THE JOURNAL IN 1839.)

PRACTICE WITH SCIENCE.

LONDON :  
JOHN MURRAY, ALBEMARLE STREET.  
1907.

**EXTRACT FROM THE SOCIETY'S BY-LAWS**

*(Dating from the Foundation of the Society):—*

“The Society will not be responsible for the accuracy of the statements or conclusions contained in the several papers in the Journal, the authors themselves being solely responsible.”

# TABLE OF CONTENTS.

VOLUME 68, 1907.

	PAGE
<b>The Agricultural Holdings Act, 1906</b> . . . . .	1
By ARTHUR P. POLEY.	
<b>Wild Birds, Useful and Injurious</b> . . . . .	17
( <i>With Seven Illustrations</i> )	
By CHARLES F. ARCHIBALD.	
<b>Injurious Fodder and Poisonous Plants</b> . . . . .	32
( <i>With Eleven Illustrations</i> )	
By HANS TH. GÜSSOW.	
<b>The Breeding and Feeding of Pigs</b> . . . . .	64
By W. WILSON.	
<b>Pigs and Bacon</b> . . . . .	71
( <i>With One Illustration</i> )	
By JOHN M. HARRIS.	
<b>Mangolds Running to Seed</b> . . . . .	79
By A. D. HALL.	
<b>American Meat Exports</b> . . . . .	81
<b>Wool Production</b> . . . . .	83
<b>Pleasure Farming</b> . . . . .	85
<b>Co-operation and Agricultural Credit</b> . . . . .	86
<b>The late Sir Massey Lopes</b> . . . . .	88
<b>The Lincoln Show, 1907</b> . . . . .	90
( <i>With Forty-eight Illustrations</i> )	
By THOMAS McROW.	
<b>The Trials of Swath Turners and Side Delivery Rakes at Lincoln, 1907</b> . . . . .	121
( <i>With Five Illustrations</i> )	
By SIR FRANCIS E. WALKER, BART.	
<b>Miscellaneous Implements Exhibited at Lincoln, 1907</b> . . . . .	130
( <i>With Four Illustrations</i> )	
By THOMAS STIRTON.	
<b>Milk and Butter Tests at the Lincoln Show, 1907</b> . . . . .	138
By ERNEST MATHEWS.	
I.—Milk-yield Tests . . . . .	138
II.—Butter Tests . . . . .	143
III.—Experiments in the Dairy . . . . .	148

	PAGE
Agricultural Education Exhibition, 1907. . . . .	152
Report on the Forestry Exhibition, 1907 . . . . .	161
By H. J. ELWES, F.R.S.	
Report on the Farm Prize Competitions, 1907 . . . . .	166
By WILLIAM H. HOGG.	
Report of the Council to the Annual General Meeting of Governors and Members of the Society, December 11, 1907 . . . . .	191
Annual Report for 1907 of the Principal of the Royal Veterinary College . . . . .	201
By PROFESSOR SIR JOHN MCFADYEAN, M.B., B.Sc., C.M. Research Laboratory, 201; Anthrax, 201; Glanders, 203; Swine Fever, 204; John's Disease, 205; Redwater in Cattle, 206; The Transmissibility of Bovine Tuberculosis to Man, 208.	
Annual Report for 1907 of the Consulting Chemist . . . . .	210
By J. AUGUSTUS VOELCKER, M.A., B.Sc., PH.D.	
Feeding Stuffs, 212; Fertilisers, 215; Miscellaneous Materials, 218.	
Annual Report for 1907 of the Consulting Botanist . . . . .	220
(With Three Illustrations)	
By WILLIAM CARRUTHERS, F.R.S.	
Purity and Germination of Seeds, 220; Duration of Vitality in Farm Seeds, 221; Weeds, 222; Diseases of Plants, 225.	
Annual Report for 1907 of the Zoologist . . . . .	229
(With Four Illustrations)	
By CECIL WARBURTON, M.A., F.Z.S.	
The Pygmy Mangold Beetle, 230; Pests infesting Buildings and Stored Produce, 232; Nursery Garden Pests, 236; Weevils, 237; Pine Shoot Tortrix, 238; Celery Fly, 238; Root-knot Eelworm, 239; Caterpillars, 240; Snails and Slugs, 241.	
The Woburn Experimental Station of the Royal Agricultural Society of England . . . . .	242
By J. AUGUSTUS VOELCKER, M.A., B.Sc., PH.D.	
Field Experiments, 1907, 242; Continuous Growing of Wheat, 245; of Barley, 250; Rotation Experiments, 251; Green-manuring Experiment, 257; Nitrate of Soda and Salt for Mangolds, 257; Lucerne, 258; Varieties of Lucerne, 259; Grass Experiments, 259; Rainfall at Woburn, 264; Pot-Culture Experiments, 1906-7, 264.	
Matters affecting British Agricultural Interests . . . . .	266
I.—Summary of Report . . . . .	266
II.—Tables of Acreage, Live Stock, and Yield of Crops . . . . .	274
III.—Prices, Imports, and Exports of Agricultural Produce . . . . .	280

	PAGE
The Weather during the Agricultural Year, 1906-1907 . . . . .	289
By FREDERICK J. BRODIE, F.R. Met. Soc.	
Rainfall, Temperature, and Bright Sunshine during 1907 . . . . .	292
The Rainfall of 1907 . . . . .	293

APPENDIX.

List of Council of Royal Agricultural Society of England . . . . .	i
Standing Committees of the Council . . . . .	iii
Chief Officials of the Society . . . . .	iv
Distribution of Governors and Members of the Society, and of Ordinary Members of the Council . . . . .	v
Governors of the Society . . . . .	vii
Honorary Members of the Society . . . . .	xiii
Summary of Members on Register, December 31, 1907 . . . . .	xiii
Life Governors and Members paying an Annual Subscription . . . . .	xiv
Table showing the Number of Governors and Members in each Year from the Establishment of the Society . . . . .	xv
Financial Statement by the Chairman of the Finance Committee . . . . .	xvi
Balance-sheet for 1907, with appended Statements of Ordinary Income and Expenditure and of Receipts and Expenditure at the Lincoln Show, 1907 . . . . .	xviii
Trust Funds held by the Royal Agricultural Society . . . . .	xxii
Statement showing Distribution of Prizes at Lincoln Show . . . . .	xxiii
Memoranda . . . . .	xxviii
Minutes of the Council Meetings in 1907 . . . . .	xxix
January 30, xxix ; February 27, xxx ; March 27, xxxi ; May 1, xxxii ; June 5, xxxiii ; June 26 and 27, xxxiv, xxxv ; July 31, xxxix ; November 6, xlii ; December 11, xliii.	
Conference of Representatives of Agricultural and Breed Societies . . . . .	xxxi
Proceedings at the General Meeting, June 27, 1907 . . . . .	xxxvi
Proceedings at the Annual General Meeting, December 11, 1907 . . . . .	xliv
Officials and Judges at the Lincoln Meeting, 1907 . . . . .	li
Awards of Prizes at Lincoln, 1907 . . . . .	lv
Prize List for Newcastle Show of 1908 . . . . .	cxxiv
Principal Additions to the Library . . . . .	cxxxiii
Index to Volume 68 . . . . .	cxxxv

ERRATUM.

Journal, Vol. 67, 1906, page 133: In Tables (1) and (2) transpose attendances on Shilling Days at Derby. Friday (1s.) Day's total should read 46,066, not 44,670; and Saturday (1s.) Day's total should read 44,670, instead of 46,066.

# Binding of the Volumes of the Journal.

GOVERNORS, MEMBERS, and others who desire to have their copies of the Journal bound in green cloth to match the Bound Volumes issued by the Society from 1901 to 1904, are requested to communicate on the subject with the Society's printers, Messrs. JAMES TRUSCOTT & SON, LTD., of Suffolk Lane, Cannon Street, London, E.C.

Messrs. TRUSCOTT & SON have contracted—(1) To bind the Volume in the green cloth cover, with gilt lettering at the back, and the Society's device in gilt at the side, at the price of 2s., including delivery of the Bound Volume; (2) To supply the green cloth lettered cases, for the use of local bookbinders, at the price of 1s. 3d. each, post free. or 1s. each, if called for at their Offices in Suffolk Lane.

Back Volumes of the Journal will also be bound in the same description of cover at the rate of 2s. 3d. per Volume; but the cases for the Volumes of the First and Second Series cannot be supplied separately.

All parcels and correspondence thereon should be addressed (*postage or carriage prepaid*) to Messrs. JAMES TRUSCOTT & SON, LTD., and *not* to the Society.

To avoid confusion the Volumes of the Journal have been re-numbered from the beginning, and the following Table shows both the Old and the New Numbers of each of the Volumes which have been issued since the first appearance of the Journal in 1839:—

NEW NUMBERS	OLD NUMBERS	NEW NUMBERS	OLD NUMBERS
<b>FIRST SERIES</b>		<b>SECOND SERIES—continued.</b>	
Vol. I. (1839-40)	Vol. I. Parts I. (i.), II. (ii.), III. (iii.), and IV. (iv.)	Vol. 40. 1879 ...	Vol. XV. Parts I. (xxix.) and II. (xxx.)
" 2. 1841 ...	II. " I. (v.) II. (vi.), & III. (vii.)	" 41. 1880 ...	" XVI. " I. (xxxii.) and II. (xxxiii.)
" 3. 1842 ...	III. " I. (viii.), II. (ix.), & III. (x.)	" 42. 1881 ...	" XVII. " I. (xxxv.) and II. (xxxvi.)
" 4. 1843 ...	IV. " I. (xi.) and II. (xii.)	" 43. 1882 ...	" XVIII. " I. (xxxvii.) and II. (xxxviii.)
" 5. 1844 ...	V. " I. (xiii.) and II. (xiv.)	" 44. 1883 ...	" XIX. " I. (xxxix.) and II. (xl.)
" 6. 1845 ...	VI. " I. (xv.) and II. (xvi.)	" 45. 1884 ...	" XX. " I. (xli.) and II. (xlii.)
" 7. 1846 ...	VII. " I. (xvii.) and II. (xviii.)	" 46. 1885 ...	" XXI. " I. (xliii.) and II. (xliv.)
" 8. 1847 ...	VIII. " I. (xix.) and II. (xx.)	" 47. 1886 ...	" XXII. " I. (xlvi.) and II. (xlvii.)
" 9. 1848 ...	IX. " I. (xxi.) and II. (xxii.)	" 48. 1887 ...	" XXIII. " I. (xlviii.) and II. (xlix.)
" 10. 1849 ...	X. " I. (xxiii.) and II. (xxiv.)	" 49. 1888 ...	" XXIV. " I. (xli.) and II. (xlii.)
" 11. 1850 ...	XI. " I. (xxv.) and II. (xxvi.)	" 50. 1889 ...	" XXV. " I. (xliii.) and II. (xliv.)
" 12. 1851 ...	XII. " I. (xxvii.) and II. (xxviii.)		
" 13. 1852 ...	XIII. " I. (xxix.) and II. (xxx.)		
" 14. 1853 ...	XIV. " I. (xxxi.) and II. (xxxii.)		
" 15. 1854 ...	XV. " I. (xxxiii.) and II. (xxxiv.)		
" 16. 1855 ...	XVI. " I. (xxxv.) and II. (xxxvi.)		
" 17. 1856 ...	XVII. " I. (xxxvii.) & II. (xxxviii.)		
" 18. 1857 ...	XVIII. " I. (xxxix.) and II. (xl.)		
" 19. 1858 ...	XIX. " I. (xli.) and II. (xlii.)		
" 20. 1859 ...	XX. " I. (xliii.) and II. (xliv.)		
" 21. 1860 ...	XXI. " I. (xlv.) and II. (xlv.)		
" 22. 1861 ...	XXII. " I. (xlvii.) and II. (xlviii.)		
" 23. 1862 ...	XXIII. " I. and II. (xlix.)		
" 24. 1863 ...	XXIV. " I. (li.) and II. (li.)		
" 25. 1864 ...	XXV. " I. (lii.) and II. (liii.)		
			<b>THIRD SERIES</b>
		Vol. 51. 1890 ...	Vol. I. Parts I. (1), II. (2), III. (3), and IV. (4)
		" 52. 1891 ...	" II. " I. (5), II. (6), III. (7), and IV. (8)
		" 53. 1892 ...	" III. " I. (9), II. (10), III. (11), and IV. (12)
		" 54. 1893 ...	" IV. " I. (13), II. (14), III. (15), and IV. (16)
		" 55. 1894 ...	" V. " I. (17), II. (18), III. (19), and IV. (20)
		" 56. 1895 ...	" VI. " I. (21), II. (22), III. (23), and IV. (24)
		" 57. 1896 ...	" VII. " I. (25), II. (26), III. (27), and IV. (28)
		" 58. 1897 ...	" VIII. " I. (29), II. (30), III. (31), and IV. (32)
		" 59. 1898 ...	" IX. " I. (33), II. (34), III. (35), and IV. (36)
		" 60. 1899 ...	" X. " I. (37), II. (38), III. (39), and IV. (40)
		" 61. 1900 ...	" XI. " I. (41), II. (42), III. (43), and IV. (44)
		" 62. 1901 ...	Issued as an Annual Bound Volume.
		" 63. 1902 ...	Issued as an Annual Bound Volume.
		" 64. 1903 ...	Issued as an Annual Bound Volume.
		" 65. 1904 ...	Issued as an Annual Bound Volume.
		" 66. 1905 ...	Issued as an Annual Volume in paper covers
		" 67. 1906 ...	Issued as an Annual Volume in paper covers
		" 68. 1907 ...	Issued as an Annual Volume in paper covers
Vol. 26. 1865 ...	Vol. I. Parts I. (i.) and II. (ii.)		
" 27. 1866 ...	II. " I. (iii.) and II. (iv.)		
" 28. 1867 ...	III. " I. (v.) and II. (vi.)		
" 29. 1868 ...	IV. " I. (vii.) and II. (viii.)		
" 30. 1869 ...	V. " I. (ix.) and II. (x.)		
" 31. 1870 ...	VI. " I. (xi.) and II. (xii.)		
" 32. 1871 ...	VII. " I. (xiii.) and II. (xiv.)		
" 33. 1872 ...	VIII. " I. (xv.) and II. (xvi.)		
" 34. 1873 ...	IX. " I. (xvii.) and II. (xviii.)		
" 5. 1874 ...	X. " I. (xix.) and II. (xx.)		
" 1875 ...	XI. " I. (xxi.) and II. (xxii.)		
" 1876 ...	XII. " I. (xxiii.) and II. (xxiv.)		
" 1877 ...	XIII. " I. (xxv.) and II. (xxvi.)		
" 1878 ...	XIV. " I. (xxvii.) and II. (xxviii.)		

(The numbers within brackets indicate the numbers as printed on the several Parts of each Series.)

209 III. (£2).—R. W. RIGGALL, Uiceby Glebe, Alford, for Uiceby Chorister, bay; s. Delamere Chorister, d. Holme Blossom 26170 by Chancellor 4969, g.d. Blossom by Good as Gold 3678.

213 R. N. & H. C.—S. E. DEAN & SONS, Dowsby Hall, Bourne, for Charterhouse Lion.

Class 20.—*Shire Entire Colts, foaled in 1905.*

219 I. (£5).—R. N. SUTTON-NELTHORPE, Scawby Hall, for Redlynch Senator 24557, bay bred by H. Percy Taunton, Redlynch, Taunton; s. Senator 2nd 6381, d. Belle of Redlynch 40884 by Redlynch Lord Harold 18306.

222 II. (£3).—J. W. MEASURES, Dunsby, Bourne, for Constitution, brown, bred by W. Richardson, Doddington, Cambs.; s. Lord Burgeon 20662, d. Bloomfield Pet 31223 by Blythwood Conqueror 14997, g.d. Bloomfield Darling 13064 by Sterling 4066.

215 III. (£2).—A. H. CLARE, Moulton Eaugate, Spalding, for Moulton Prince of Wales 24465, brown, bred by G. L. Morris, Thorney; s. Normoor Statesman 18986, d. Fenland Damsel 38904 by Thorney Topsman 16425.

218 R. N. & H. C.—R. J. EPTON, Northolme, Wainfleet for Northolme Harold.

## SHEEP.

## Lincolnshire Long Wool.

Class 21.—*Lincoln Shearling Rams.*

227 I. (£5).—TOM CASSWELL, Pointon, Folkingham.

234 II. (£3) & 233 R. N. & H. C.—S. E. DEAN & SONS, Dowsby Hall, Bourne.

236 III. (£2).—HENRY DUDDING, Riby Grove, Great Grimsby.

Class 22.—*Three Lincoln Shearling Rams.*

254 I. (£5).—HENRY DUDDING, Riby Grove, Great Grimsby.

253 II. (£3).—S. E. DEAN & SONS, Dowsby Hall, Bourne.

257 III. (£2).—FREDERICK WARD, Quarrington, Sleaford.

Class 23.—*Three Lincoln Shearling Rams, exhibited by Members who have never won a Prize at the R.A.S.E.*

271 I. (£10).—HENRY CASSWELL, Quadring, Spalding.

274 II. (£5), & 275 III. (£3).—GEORGE MARRIS, Kirmington, Brocklesby.

265 R. N. & H. C.—CHARLES FEATHERSTONE, The Grange, Nocton, Lincoln.

Class 24.—*Three Lincoln Shearling Ewes.*

279 I. (£5).—TOM CASSWELL, Pointon, Folkingham.

282 II. (£3).—HENRY CASSWELL, Quadring, Spalding.

278 III. (£2).—HENRY DUDDING, Riby Grove, Great Grimsby.

284 R. N. & H. C.—S. E. DEAN & SONS, Dowsby Hall, Bourne.

BUTTER.<sup>1</sup>Class 25.—*Two Pounds of Butter.*

3 (20s).—MRS. EMILY B. DENNY, Bark with House, East Bark with, Lincoln.

8 (20s).—MISS DORA BATTERSBY, Bassingham, Lincoln.

18 (20s).—MISS C. SCHOFIELD, The Grange, Kirton Lindsey.

4 (10s).—MRS. WILLEY, Cadney, Brigg.

13 (10s).—MRS. W. BATTERSBY, Bassingham, Lincoln.

17 (10s).—MISS ETHEL OLDFIELD, Sturton-by-Stow, Lincoln.

5 (5s).—A. M. COPPING, Cabourn Parver, Caistor.

20 (5s).—MRS. VASEY, The Grange, Welton, Lincoln.

24 (5s).—MRS. HARRIET FIDDLING, North Cotes, S.O.

15 R. N. & H. C.—MISS ANNIE E. SLINGSBY, North Scarle, Newark.

Class 26.—*Three Pounds unsalted Butter, made by Farmers' Wives and Daughters residing within the confines of the Burton Hunt, from Cream produced by their own Cows.*

30 I. (£3).—MRS. MARY BURKITT, Faldingworth, Lincoln.

27 II. (£2).—MRS. C. W. CROSS, Hemswell Cliff, Lincoln.

39 III. (£1).—MRS. JOSEPH ODLING, Buslingthorpe Hall, Lincoln.

<sup>1</sup> Prizes given by the County Councils of Lindsey, Kesteven, and Holland, to be competed for by Residents in Lincolnshire only.

**EGGS.<sup>1</sup>**

**Class 27.—*Twelve English Hens' White Eggs.***

- 34 I. (15s.)—P. J. BRADSHAW, Borderville, Stamford.
- 35 II. (10s.)—EDWARD F. DUCKERING, Station Road, Kirton Lindsey.
- 31 III. (5s.)—F. FRED. NICHOLSON, Willoughton Manor, Lincoln.

**Class 28. *Twelve English Hens' Brown Eggs.***

- 42 I. (15s.)—ANNIE JEKYLL, Lincoln.
- 41 II. (10s.)—JAMES KEAL, Sturton-by-Stow, Lincoln.
- 38 III. (5s.)—P. J. BRADSHAW, Borderville, Stamford.
- 40 R. N. & H. C.—MRS. H. K. REED, Monks Dyke Road, Louth.

**TABLE POULTRY.<sup>1</sup>**

**Class 29.—*Couples of Chickens (dressed) hatched and reared in 1907.***

- 51 I. (15s.)—MRS. H. GRANTHAM, North Thoresby, R.S.O.
- 47 II. (10s.)—MRS. HARRIET FIDDLING, North Cotes, S.O.
- 45 III. (5s.)—MRS. PEREIRA FRANCIS BROWN, Digby Manor, Lincoln.
- 44 R. N. & H. C.—MRS. MARY VICKERS, Doddington, Lincoln.

**Class 30.—*Couples of Ducks (dressed) hatched and reared in 1907.***

- 53 I. (15s.)—JAMES KEAL, Sturton-by-Stow, Lincoln.
- 57 II. (10s.)—MRS. STEPHENS, Sturton-by-Stow, Lincoln.
- 54 III. (5s.)—EDWARD F. DUCKERING, Station Road, Kirton Lindsey.
- 55 R. N. & H. C.—E. J. EVISON, Princess Street, Lincoln.

**BUTTER-MAKING COMPETITION.<sup>1</sup>**

**Class A.—*Women exceeding 18 years of age.***

- 58 I. (£4.)—MRS. W. BATTERSBY, Bassingham, Lincoln.
- 68 II. (£3.)—MISS LENA ANYAN, Lea Grange, Gainsborough.
- 65 III. (£2.)—MISS MAUDE IREMONGER, Glebe Farm, Benniworth, Lincoln.
- 67 IV. (£1.)—MISS ELSIE S. ADLARD, Rose Cottage, Louth.
- 61 R. N. & H. C.—MISS ETHEL OLDFIELD, Sturton-by-Stow, Lincoln.

**Class B.—*Girls not exceeding 18 years of age.***

[No Award.]

**SERVANTS AND LABOURERS.**

**Class 1.—*Working Agricultural Foremen or Bailiffs who have lived continuously in that capacity the greatest number of years in the service of one family or their successors, or on the same farm, not less than 5 years.***

- 8 I. (£4.)—JOHN STAINTON, Grange Farm, Winterton, Doncaster, 39 years.
- 6 II. (£3.)—WILLIAM HOLMES, Rothwell Vale, Caistor, 39 years.
- 5 III. (£2.)—EDWARD HOLMES, Mere Hall Farm, Lincoln, 37 years 8 months.
- 9 IV. (£1.)—JOHN THORPE, Wilsford, Grantham, 35 years.

**Class 2.—*Shepherds solely employed by one person or partners, who have lived continuously in that capacity the greatest length of time in the service of one family or their successors, or on the same farm, not less than 5 years.***

- 12 I. (£4.)—JOSEPH BAKER, Stones Place, Skellingthorpe, Lincoln, 37 years.
- 20 II. (£3.)—CHARLES OGDEN, Wellingore, Lincoln, 37 years.
- 21 III. (£2.)—JOHN RIPPINGALE, Welton, Lincoln, 36 years.
- 22 IV. (£1.)—JOHN THORNTON, Birthorpe, Fellingthorpe, 34 years 8 months.

<sup>1</sup> Prizes given by the County Councils of Lindsey, Kesteven, and Holland, to be competed for by Residents in Lincolnshire only.



**Class 3.**—*Shepherds who have reared the greatest proportionate number of lambs from not less than 200 ewes and gimmers belonging to the same person or partners.*

- 23 I. (£4).—EDWARD RANYARD, Anderby Grange, Huttoft, S.O.  
 27 II. (£2).—FREDERICK MUXTON, Rauceby Hall, Grantham.  
 24 & 32 (Equal Prize of £1 each).—WILLIAM BECKETT, Wellingore, Lincoln, and WILLIAM WABY, Broughton Vale, Brigg.

**Class 4.**—*Shepherds who have reared the greatest proportionate number of lambs, from not less than 50, nor more than 199, ewes and gimmers belonging to the same person or partners.*

- 34 I. (£4).—WILLIAM FISHER, Bourne.  
 35 II. (£2).—ROBERT GREEN, High Tointon, Horncastle.  
 37 III. (£1).—THOMAS WILKINSON, Manby Hall, Louth.

**Class 5.**—*Labourers in Husbandry who have brought up and placed out the greatest number of children, without having ever received parochial relief, not having occupied more than half an acre of land.*

- 39 I. (£4).—CHARLES EDWARD BLANCHARD, 16 King John Street, Sleaford. 19 children born, 14 brought up and 14 placed out.  
 40 II. (£3).—GEORGE FARMERY, Hemswell, Lincoln. 23 children born, 17 brought up, and 12 placed out.

**Class 6.**—*Farm Waggoners who have lived continuously in that capacity the greatest number of years, in the service of one family or their successors, or on the same farm, not less than 5 years.*

- 47 I. (£3).—THOMAS RASTALL, Harston, Grantham, 39 years.  
 44 II. (£2).—JOHN DRAKARD, Deeping St. Nicholas, Spalding, 27 years.  
 45 III. (£1).—CHRISTOPHER JACKSON, Aswardby, Spilsby, 25 years.

**Class 7.**—*Married men, or widowers, being servants in husbandry, who have lived or worked exclusively and continuously in the service of one family or their successors, or on the same farm, the greatest number of years, not less than 5.*

- 61 I. (£5).—MARK JACKSON, Darlows Yard, Sleaford, 56 years.  
 59 II. (£4).—WILLIAM HOLMES, Rigsby, Alford, 55 years.  
 66 III. (£3).—ROBERT PADDISON, Croxby, Caistor, 52 years.  
 62 IV. (£2).—THOMAS BUGG, Leadenhall, Lincoln, 52 years.  
 57 V. (£1).—ROBERT HEDWORTH, Harston, Grantham, 50 years.

**Class 8.**—*Servants in Husbandry, who have lived or worked in any two or more different capacities, in the exclusive and continuous service of one family or their successors, or on the same farm, the greatest number of years, not less than 5.*

- 74 I. (£3).—JOHN HODGKIN, Colsterworth, Grantham, 46½ years as General Labourer.  
 73 II. (£2).—WILLIAM HAYWARD, Scopwick, Lincoln, 42 years as Engine Driver and Labourer.  
 72 III. (£1).—JOHN GIBSON, Branston, Lincoln, 38 years as Waggoner, Shepherd, and Foreman.

**Class 9.**—*Working Agricultural Blacksmiths or Carpenters, brought up to either of those businesses (not having shops of their own), who have worked continuously in either capacity the greatest number of years in the service of one family or their successors, or on the same farm, not less than 5 years.*

- 84 I. (£3).—JAMES WILSON, Woolsthorpe, Colsterworth, Grantham, 25 years as Carpenter.  
 83 II. (£1).—CHARLES ONYON, Eastgate, Sleaford, 22½ years as Carpenter.  
 81 (Gratuity of £1).—JOHN CARTER, Howell, Heckington, 40 years as Carpenter.

**Class 10.**—*Female Servants who have lived the greatest number of years continuously in the service of one family or their successors, not less than 5 years.*

- 85 I. (£3).—JANE ALLEN, Dyke, Bourne, 30 years.  
 87 II. (£2).—EMILY HARTLEY, The Uplands, Lincoln, 28 years 5 months.  
 86 III. (£1).—BETSY ANN HILTON, Sleaford, 24 years.

**PRIZE LIST**For **NEWCASTLE SHOW, JUNE 30 to JULY 4, 1908.**

Total value of Prizes offered (inclusive of Champion Prizes, Special Prizes, Cups, Medals, and Class Prizes), 10,560*l.*, of which amount 2,002*l.* are contributions from the Newcastle Local Committee, 300*l.* from the Northumberland and Durham Agricultural Societies, 2,176*l.* 5*s.* from various Breed Societies, 769*l.* from other sources, and 281*l.* from the Northumberland Agricultural Society for the Local Classes.

**CHAMPION PRIZES.**

The following Champion Prizes are offered by Breed Societies:—

**HORSES.**

- HUNTERS' IMPROVEMENT SOCIETY:**—Two Gold Medals for the best Hunter Mare 4 years and upwards, and for the best Filly not exceeding 2 years old.
- POLO AND RIDING PONY SOCIETY:**—Two Gold Medals for the best Polo and Riding Pony Stallion or Colt, and for the best Mare or Filly.
- HACKNEY HORSE SOCIETY:**—Two Gold Medals, value 10*l.* each (or 10*l.* in money), for the best Hackney Stallion, and for the best Mare or Filly.
- SHETLAND PONY STUD BOOK SOCIETY:**—Silver Medal for the best Shetland Pony Stallion.
- SHIRE HORSE SOCIETY:**—Two Gold Medals, value 10*l.* each (or 10*l.* in money), for the best Shire Stallion, and for the best Mare or Filly, and 5*l.* each to the Breeders of the Champion Shire Stallion, and Mare or Filly.
- CLYDESDALE HORSE SOCIETY:**—Two Prizes of 10*l.* each for the best Clydesdale Stallion, and for the best Mare or Filly.
- SUFFOLK HORSE SOCIETY:**—Challenge Cup, value fifty guineas, for the best Suffolk Stallion.
- HACKNEY HORSE SOCIETY:**—Gold Medal (or 5*l.* in money) for the best Mare or Gelding in the Single Driving Classes, the produce of a Registered Hackney Stallion.

**CATTLE.**

- SHORTHORN SOCIETY:**—Two Prizes of 30*l.* each for the best Shorthorn Bull, and for the best Cow or Heifer; and 5*l.* each to the Breeders of the First Prize animals in the Inspection Classes for Shorthorns.
- DAIRY SHORTHORN (COATES'S HERD BOOK) ASSOCIATION:**—Prize of 10*l.* for the best Pedigree Shorthorn Dairy Cow or Heifer.
- HEREFORD HERD BOOK SOCIETY:**—Two Prizes of 10*l.* 10*s.* each for the best Hereford Bull, and for the best Cow or Heifer.
- DEVON CATTLE BREEDERS' SOCIETY:**—Two Prizes of 10*l.* 10*s.* each for the best Devon Bull, and for the best Cow or Heifer.
- SUSSEX HERD BOOK SOCIETY:**—Silver Medal for the best Sussex Bull.
- RED POLLED SOCIETY:**—Two Prizes of 5*l.* each for the best Red Polled Bull, and for the best Cow or Heifer.
- POLLED CATTLE SOCIETY:**—A Gold Medal for the best breeding animal of the Aberdeen Angus breed.
- ENGLISH ABERDEEN ANGUS CATTLE ASSOCIATION:**—A Gold Medal for the best animal of the opposite sex to that of the animal awarded the Gold Medal of the Polled Cattle Society.
- GALLOWAY CATTLE SOCIETY:**—Two Prizes of 5*l.* 5*s.* each for the best Galloway Bull, and for the best Cow or Heifer.
- ENGLISH KERRY AND DEXTER CATTLE SOCIETY:**—Two Challenge Cups, value 25*l.* 5*s.* each, for the best Kerry Bull, Cow, or Heifer, and for the best Dexter Bull, Cow, or Heifer.
- ENGLISH JERSEY CATTLE SOCIETY:**—Gold Medal (or 10*l.* in money), Silver Medal, and Bronze Medal for the three best Jersey Animals in the Butter-test Classes.

**SHEEP.**

- SOUTHDOWN SHEEP SOCIETY:**—A Gold Medal (or 10*l.* 10*s.* in money) for the best Southdown Ram; and Silver Medal for the best Pen of Ewes or Ewe Lambs.
- HAMPSHIRE DOWN SHEEP BREEDERS' ASSOCIATION:**—Prize of 10*l.* for the best Pen of Hampshire Down Ram Lambs, or Ewe Lambs.
- LINCOLN LONG-WOOL SHEEP BREEDERS' ASSOCIATION:**—A Piece of Plate, value 5*l.* for the best Lincoln Ram.
- SOCIETY OF BORDER LEICESTER SHEEP BREEDERS:**—A Challenge Cup, value 10*l.* for the best Border Leicester Sheep.
- CHEVIOT SHEEP SOCIETY:**—Challenge Cup for the best Cheviot Sheep.

**PIGS.**

- NATIONAL PIG BREEDERS' ASSOCIATION:**—Three Gold Medals, or 5*l.* 5*s.* in money, for the best Large White Boar or Sow, Middle White Boar or Sow, and Tamworth Boar or Sow.
- BRITISH BERKSHIRE SOCIETY:**—Prize of 5*l.* 5*s.* for the best Berkshire Boar or Sow.
- LARGE BLACK PIG SOCIETY:**—Prize of 10*l.* for the best Large Black Boar; and a Challenge Cup, value twenty guineas, for the best Large Black Sow.
- LINCOLNSHIRE CURLY-COATED PIG BREEDERS' ASSOCIATION:**—Two Prizes of 5*l.* each, for the best Lincolnshire Curly-coated Boar and the best Sow.

**HORSES (£3,421).**

	Prizes			Prizes		
	1st	2nd	3rd	1st	2nd	3rd
<b>HUNTERS.<sup>1</sup></b>						
COLT OR GELDING, foaled in 1907	20	10	5			
GELDING, foaled in 1906	20	10	5			
GELDING, foaled in 1905	20	10	5			
FILLY, foaled in 1907	20	10	5			
FILLY, foaled in 1906	20	10	5			
FILLY, foaled in 1905	20	10	5			
MARE, with foal at foot (up to 14 st.)	20	10	5			
MARE, with foal at foot (up to more than 14 st.)	20	10	5			
COLT FOAL, produce of Mare in above classes	10	5	3			
FILLY FOAL, produce of Mare in above classes	10	5	3			
SPECIAL PRIZES of 10l. each for the best Hunter Colt or Gelding, Filly, and Brood Mares; and 5l. each for the best Colt Foal and Filly Foal. <sup>2</sup>						
<b>POLO AND RIDING PONIES.<sup>3</sup></b>						
STALLION, foaled in or before 1905, not over 14 h. 2 in.	15	10	5			
COLT, FILLY, OR GELDING, foaled in 1907, not over 13 h. 3 in.	15	10	5			
COLT, FILLY, OR GELDING, foaled in 1906, not over 14 h. 1 in.	15	10	5			
FILLY OR GELDING, foaled in 1905, not over 14 h. 1½ in.	15	10	5			
MARE (with foal at foot), not over 14 h. 2 in.	15	10	5			
A SPECIAL PRIZE of 10l. for the best Polo and Riding Pony Mare or Filly. <sup>2</sup>						
<b>CLEVELAND BAYS AND COACH HORSES.</b>						
STALLION, foaled in 1905 or 1906	15	10	5			
FILLY, foaled in 1905	15	10	5			
FILLY, foaled in 1906	15	10	5			
MARE (with foal at foot)	15	10	5			
<b>HACKNEYS.<sup>4</sup></b>						
STALLION, foaled in 1907	20	10	5			
STALLION, foaled in 1906	20	10	5			
STALLION, foaled in 1905	20	10	5			
FILLY, foaled in 1907	20	10	5			
FILLY, foaled in 1906	20	10	5			
FILLY, foaled in 1905	20	10	5			
MARE (with foal at foot), over 14 h., and not over 15 h. 2 in.	20	10	5			
MARE (with foal at foot), over 15 h. 2 in.	20	10	5			
FOAL, produce of Mare in above classes	10	5	3			
A SPECIAL PRIZE of 10l. for the best Hackney Mare or Filly. <sup>2</sup>						
<b>HACKNEY PONIES.<sup>5</sup></b>						
STALLION, foaled in or before 1905, not over 14 h.	15	10	5			
COLT, FILLY, OR GELDING, foaled in 1906, not over 13 h. 2 in.	15	10	5			
FILLY OR GELDING, foaled in 1905, not over 13 h. 3 in.	15	10	5			
MARE (with foal at foot), not over 14 h.	15	10	5			
A SPECIAL PRIZE of 10l. for the best Hackney Pony Mare or Filly. <sup>2</sup>						
<b>SHETLAND PONIES.</b>						
STALLION, foaled in or before 1905, not over 10½ h.	10	5	3			
MARE, foaled in or before 1905, not over 10½ h.	10	5	3			
<b>HIGHLAND OR FELL PONIES.<sup>6</sup></b>						
STALLION, foaled in or before 1905, not over 14 h. 2 in.	10	5	3			
MARE, foaled in or before 1905, not over 14 h. 2 in.	10	5	3			
<b>DALES PONIES.<sup>6</sup></b>						
STALLION, foaled in or before 1905, not over 14 h. 2 in.	10	5	3			
MARE, foaled in or before 1905, not over 14 h. 2 in.	10	5	3			
<b>SHIRE.<sup>7</sup></b>						
STALLION, foaled in 1907	20	10	5			
STALLION, foaled in 1906	20	10	5			
STALLION, foaled in 1905	20	10	5			
FILLY, foaled in 1907	20	10	5			
FILLY, foaled in 1906	20	10	5			
FILLY, foaled in 1905	20	10	5			
MARE (with foal at foot)	20	10	5			
COLT FOAL, produce of mare in above class	10	5	3			
FILLY FOAL, produce of mare in above class	10	5	3			
SPECIAL PRIZES of 10l. each for best Stallion and best Mare or Filly. <sup>2</sup>						
<b>CLYDESDALE.<sup>8</sup></b>						
STALLION, foaled in 1907	20	10	5			
STALLION, foaled in 1906	20	10	5			
STALLION, foaled in 1905	20	10	5			
FILLY, foaled in 1907	20	10	5			
FILLY, foaled in 1906	20	10	5			
FILLY, foaled in 1905	20	10	5			
MARE (with foal at foot)	20	10	5			
FOAL, produce of mare in above class	10	5	3			
SPECIAL PRIZES of 10l. each for the best Clydesdale Stallion, Filly, and Mare, and 5l. each for the best Colt Foal and Filly Foal. <sup>2</sup>						
<b>SUFFOLK.<sup>9</sup></b>						
STALLION, foaled in 1906	20	10	5			
STALLION, foaled in 1905	20	10	5			
FILLY, foaled in 1906	20	10	5			
FILLY, foaled in 1905	20	10	5			
MARE (with foal at foot)	20	10	5			

<sup>1</sup> £120 provided by gentlemen interested in the breed.  
<sup>2</sup> Offered by the Northumberland and Durham Agricultural Societies.  
<sup>3</sup> £50 provided by the Polo and Riding Pony Society.  
<sup>4</sup> £60 provided by the Hackney Horse Society.  
<sup>5</sup> £40 provided by the Hackney Horse Society.  
<sup>6</sup> £16 provided by gentlemen interested in the breed.  
<sup>7</sup> £70 provided by the Shire Horse Society.  
<sup>8</sup> £50 provided by the Clydesdale Horse Society.  
<sup>9</sup> £20 provided by the Suffolk Horse Society.

	Prizes			
	1st	2nd	3rd	4th
<b>DRAUGHT GELDING.<sup>1</sup></b>				
GELDING, foaled in 1904 or 1905. 20	10	5		
A SPECIAL PRIZE of 10l. for the best Draught Gelding. <sup>2</sup>				

	Prizes			
	1st	2nd	3rd	4th
<b>RIDING CLASSES.<sup>1</sup></b>				
<i>Hunters.</i>				
MARE OR GELDING, foaled in 1904, up to from 12 st. to 14 st.	20	10	5	-
MARE OR GELDING, foaled in 1904, up to more than 14 st.	20	10	5	-
MARE OR GELDING (Novice), foaled in or before 1903, up to from 12 st. to 14 st.	20	10	5	-
MARE OR GELDING (Novice), foaled in or before 1903, up to more than 14 st.	20	10	5	-
MARE OR GELDING, foaled in or before 1904, up to from 12 st. to 13 st. 7 lb.	20	10	6	4
MARE OR GELDING, foaled in or before 1904, up to more than 13 st. 7 lb. and not over 15 st.	20	10	6	4
MARE OR GELDING, foaled in or before 1904, up to more than 15 st.	20	10	6	4
SPECIAL PRIZES of 10l. each for the best Hunter Mare and Gelding. <sup>2</sup>				

	Prizes			
	1st	2nd	3rd	4th
<i>Polo and Riding Pony.</i>				
MARE OR GELDING, foaled in 1903 or 1904, not over 14 h. 2 in.	15	10	5	-

	Prizes			
	1st	2nd	3rd	4th
<b>DRIVING CLASSES.<sup>1</sup></b>				
<i>To be driven in Single Harness.</i>				
MARE OR GELDING (Novice), not over 13 h. 2 in.	10	6	4	-
MARE OR GELDING (Novice), over 13 h. 2 in. and not over 14 h.	10	6	4	-
MARE OR GELDING (Novice), over 14 h. and not over 14 h. 2 in.	10	6	4	-
MARE OR GELDING (Novice), over 14 h. 2 in. and not over 15 h.	10	6	4	-
MARE OR GELDING (Novice), over 15 h. and not over 15 h. 2 in.	10	6	4	-
MARE OR GELDING (Novice), over 15 h. 2 in.	10	6	4	-
MARE OR GELDING, not over 14 h.	15	10	6	4
MARE OR GELDING, over 14 h. and not over 15 h.	15	10	6	4
MARE OR GELDING, over 15 h.	15	10	6	4
<i>Pace and Action.</i>				
SINGLE HARNESS HORSE	15	10	6	4

	Prizes			
	1st	2nd	3rd	4th
<b>DRIVING CLASSES</b>				
<i>(continued).</i>				
<i>To be driven in Double Harness.</i>				
MARES OR GELDINGS, not over 15 h. 2 in.	15	10	5	-
MARES OR GELDINGS, over 15 h. 2 in.	15	10	5	-
<i>To be driven Tandem.</i>				
MARES OR GELDINGS, not over 15 h.	15	10	5	-
MARES OR GELDINGS, over 15 h.	15	10	5	-
<i>Four-in-hand Teams.</i>				
MARES OR GELDINGS, to be shown before a Coach	25	15	10	5
A CHALLENGE CUP, value 50l., for the best team. <sup>2</sup>				

	Prizes		
	1st	2nd	3rd
<b>PIT PONIES.<sup>1</sup></b>			
<i>To be shown in Gears.</i>			
Two Ponies, not over 11 h.	10	5	3
Two Ponies, over 11 h. and not over 12 h. 2 in.	10	5	3

	Prizes			
	1st	2nd	3rd	4th
<b>DRAUGHT HORSES.</b>				
MARE OR GELDING, to be shown in Cart or Lurry <sup>1</sup>	15	10	6	4
TEAM OF TWO, to be shown in Lurry or Waggon <sup>1</sup>	15	10	6	4
TEAM OF FOUR, to be shown in Lurry or Waggon <sup>1</sup>	25	15	10	6
TEAM OF FOUR SUFFOLKS, to be shown in Lurry or Waggon <sup>4</sup>	20	10	-	-

	Prizes				
	1st	2nd	3rd	4th	5th
<b>JUMPING COMPETITIONS.<sup>1</sup></b>					
A MARE OR GELDING, not over 15 h. 2 in.	20	15	10	-	-
B MARE OR GELDING, over 15 h. 2 in.	20	15	10	-	-
C MARE OR GELDING, any height (Prize Winners in Classes A and B not eligible)	20	15	10	-	-
D CHAMPION CLASS, Mare or Gelding, any height	20	15	10	8	6
<i>High Jumping.</i>					
E HORSE, any height	30	15	10	5	-

**CATTLE (£2,799).**

	Prizes		
	1st	2nd	3rd
<b>SHORTHORN.</b>			
BULL, calved in 1903, 1904 or 1905	15	6	4
BULL, calved on or between Jan. 1, 1904, and June 30, 1904	10	6	4
BULL, calved on or between July 1, 1904, and Dec. 31, 1904	10	6	4

<sup>1</sup> Offered by the Newcastle Local Committee.  
<sup>2</sup> Offered by the Northumberland and Durham Agricultural Societies.  
<sup>3</sup> Offered by Gentlemen interested in Coaching.  
<sup>4</sup> Offered by the Suffolk Horse Society.  
<sup>5</sup> Offered by the Shorthorn Society.

Prizes for Horses and Cattle, 1908.

CXKVII

HORN (continued).	Prizes		
	1st £	2nd £	3rd £
calved on or between 1907, and June 30, 1907	10	6	4
calved on or between 1907, and Dec. 31, 1907	10	6	4
in-milk, calved in or before 1904	10	6	4
in-milk, calved in 1905 <sup>1</sup>	10	6	4
calved in 1906	10	6	4
calved in 1907	10	6	4
COW, in-milk, calved before 1903 <sup>1</sup>	10	6	4
COW, in-milk, calved in 1904	10	6	4
HEIFER, in-milk, calved after 1905 <sup>2</sup>	10	6	4
Yield Prizes	10	6	4
VER CUP, value 25L., for the best animal bred in the County of			

1. SPECIAL PRIZE of 20L. for the best animal exhibited by a tenant in Northumberland or Durham.<sup>3</sup>  
2. AL PRIZES of 10L. each for the northern Bull, calved in 1903, 1904, 1906; Bull, calved in 1907; Cow, and Dairy Cow or Heifer.<sup>4</sup>

3. CLASS, consisting of a female of any age (the property of the exhibitor), and not necessarily bred in the County, and three of his progeny, the property of the exhibitor.<sup>1</sup>

4. CLASS, consisting of a female of any age (not necessarily bred by Exhibitor), and of her produce in direct descent on the female side, the property of the exhibitor.<sup>1</sup>

LINCOLNSHIRE RED SHORT-HORN.	1st £	2nd £	3rd £
calved in 1903, 1904, or 1905	10	6	4
calved in 1906 <sup>5</sup>	10	6	4
calved in 1907 <sup>5</sup>	10	6	4
in-milk, calved in or before 1904	10	6	4
in-milk, calved in 1905	10	6	4
calved in 1906 <sup>5</sup>	10	6	4
calved in 1907 <sup>5</sup>	10	6	4
Yield Prizes	10	6	4

HEREFORD. <sup>6</sup>	1st £	2nd £	3rd £
calved in 1903, 1904, or 1905	10	6	4
calved in 1906	10	6	4
calved in 1907	15	10	4
HEIFER, in-milk, calved in or before 1905	10	6	4
calved in 1906	10	6	4
calved in 1907	10	6	4

<sup>1</sup> provided by the Shorthorn Society.  
<sup>2</sup> provided by the Dairy Shorthorn (Gontes's Herd Book) Association.  
<sup>3</sup> provided by the Newcastle Farmers' Club.  
<sup>4</sup> provided by the Northumberland and Durham Agricultural Societies.  
<sup>5</sup> provided by the Lincolnshire Red Short-horn Association.  
<sup>6</sup> provided by the Hereford Herd Book Society.  
<sup>7</sup> provided by Breeders of South Devon Cattle.  
<sup>8</sup> provided by the Sussex Herd Book Society.  
<sup>9</sup> provided by the Welsh Black Cattle Society.  
<sup>10</sup> provided by the Red Polled Society.  
<sup>11</sup> provided by the Newcastle Local Committee.

DEVON.	Prizes		
	1st £	2nd £	3rd £
BULL, calved in 1903, 1904, 1905, or 1906	10	6	-
BULL, calved in 1907	10	6	-
COW OR HEIFER, in-milk, calved in or before 1905	10	6	-
HEIFER, calved in 1906	10	6	-
HEIFER, calved in 1907	10	6	-

SOUTH DEVON. <sup>7</sup>	1st £	2nd £	3rd £
BULL, calved in 1903, 1904, 1905, or 1906	10	6	-
BULL, calved in 1907	10	6	-
COW OR HEIFER, in-milk, calved in or before 1905	10	6	-
HEIFER, calved in 1906 or 1907	10	6	-
Milk Yield Prizes	10	6	4

SUSSEX. <sup>8</sup>	1st £	2nd £	3rd £
BULL, calved in 1903, 1904, 1905, or 1906	15	8	4
BULL, calved in 1907	15	8	4
COW OR HEIFER, in-milk, calved in or before 1905	15	8	4
HEIFER, calved in 1906	15	8	4
HEIFER, calved in 1907	15	8	4

WELSH. <sup>9</sup>	1st £	2nd £	3rd £
BULL, calved on or after Dec. 1, 1902, and before Dec. 1, 1906	10	6	-
BULL, calved on or after Dec. 1, 1906, and before Dec. 1, 1907	10	6	-
COW OR HEIFER, in-milk, calved before Dec. 1, 1905	10	6	-
HEIFER, calved on or after Dec. 1, 1905, and before Dec. 1, 1906	10	6	-
HEIFER, calved on or after Dec. 1, 1906, and before Dec. 1, 1907	10	6	-

RED POLLED. <sup>10</sup>	1st £	2nd £	3rd £
BULL, calved in 1903, 1904, 1905, or 1906	10	6	4
BULL, calved in 1907	10	6	4
COW OR HEIFER, in-milk, calved in or before 1905	10	6	4
HEIFER, calved in 1906	10	6	4
HEIFER, calved in 1907	10	6	4
Milk Yield Prizes	10	6	4

ABERDEEN ANGUS. <sup>11</sup>	1st £	2nd £	3rd £
BULL, calved on or after Dec. 1, 1902, and before Dec. 1, 1905	15	10	4
BULL, calved on or after Dec. 1, 1905, and before Dec. 1, 1906	15	10	4
BULL, calved on or after Dec. 1, 1906, and before Dec. 1, 1907	15	10	4
COW OR HEIFER, in-milk, calved before Dec. 1, 1904	15	10	4
HEIFER, in-milk, calved on or after Dec. 1, 1904, and before Dec. 1, 1905	15	10	4

cxxviii *Prize List for Newcastle Show, 1908.*

ABERDEEN ANGUS <sup>1</sup> (continued).	Prizes			LONGHORN. <sup>9</sup>	Prizes		
	1st	2nd	3rd		1st	2nd	3rd
HEIFER, calved on or after Dec. 1, 1905, and before Dec. 1, 1906.	15	10	4	BULL, calved in 1903, 1904, 1905, 1906, or 1907.	10	6	4
HEIFER, calved on or after Dec. 1, 1906, and before Dec. 1, 1907.	15	10	4	COW OR HEIFER, in-milk, calved in or before 1905.	10	6	4
GROUP CLASS, of not less than four animals of any sex entered in above Classes.	15	10	-	Milk Yield Prizes.	10	6	4
SPECIAL PRIZES of 10l. each for the best Bull and Cow or Heifer <sup>2</sup>				<b>KERRY.</b>			
<b>GALLOWAY.<sup>3</sup></b>				BULL, calved in 1903, 1904, 1905, or 1906.	10	6	4
BULL, calved on or after Dec. 1, 1902, and before Dec. 1, 1906.	15	10	4	COW OR HEIFER, in-milk, calved in or before 1905.	10	6	4
BULL, calved on or after Dec. 1, 1906, and before Dec. 1, 1907.	15	10	4	HEIFER, calved in 1906 or 1907. <sup>10</sup>	10	6	4
COW OR HEIFER, in-milk, calved before Dec. 1, 1905.	15	10	4	Milk Yield Prizes.	10	6	4
HEIFER, calved on or after Dec. 1, 1905, and before Dec. 1, 1906.	15	10	4	<b>DEXTER.</b>			
HEIFER, calved on or after Dec. 1, 1906, and before Dec. 1, 1907.	15	10	4	BULL, calved in 1903, 1904, 1905, or 1906.	10	6	4
<b>HIGHLAND.<sup>4</sup></b>				COW, in-milk, calved in or before 1904.	10	6	4
BULL, calved in or before 1905.	10	6	4	HEIFER, in-milk, calved in 1905. <sup>10</sup>	10	6	4
BULL, calved in 1906 or 1907.	10	6	4	HEIFER, calved in 1906 or 1907.	10	6	4
COW OR HEIFER, in-milk, calved in or before 1904.	10	6	4	Milk Yield Prizes.	10	6	4
HEIFER, calved in 1905, '06, or '07.	10	6	4	<b>SPECIAL MILK YIELD.</b>			
<b>AYRSHIRE.</b>				(Judged without Inspection.)			
BULL, calved in 1903, '04, '05, or '06.	10	6	4	COW, in-milk, of any age, breed, or cross. <sup>9</sup>	20	10	5
BULL, calved in 1907. <sup>5</sup>	10	6	4	<b>BUTTER TESTS.<sup>6</sup></b>			
COW OR HEIFER, in-milk, calved in or before 1905.	10	6	4	COW, of any age, breed, or cross, exceeding 800 lb. live weight.	15	10	5
COW OR HEIFER, in-calf, calved in or before 1905. <sup>8</sup>	10	6	4	COW, of any age, breed, or cross, not exceeding 900 lb. live weight.	15	10	5
HEIFER, calved in 1906 or 1907.	10	6	4	SPECIAL PRIZES for the 3 cows in above classes obtaining the greatest number of points in the competition.	20	10	5
Milk Yield Prizes.	10	6	4	<b>SHEEP (£1,763 10s.).</b>			
<b>JERSEY.</b>				<b>OXFORD DOWN.<sup>11</sup></b>			
BULL, calved 1903, '04, '05, or '06.	10	6	4	SHEARLING RAM.	10	5	3
BULL, calved in 1907.	10	6	4	THREE RAM LAMBS, dropped in 1908.	10	5	3
COW, in-milk, calved in or before 1904.	10	6	4	THREE SHEARLING EWES.	10	5	3
HEIFER, in-milk, calved in 1905.	10	6	4	THREE EWE LAMBS, dropped in 1908.	10	5	3
HEIFER, in-milk, calved in 1906.	10	6	4				
HEIFER, calved in 1907.	10	6	4	<b>SHROPSHIRE.</b>			
COW OR HEIFER, in-milk, bred by Exhibitor, sired in Great Britain or Ireland. <sup>7</sup>	10	6	4	Prizes			
Milk Yield Prizes.	10	6	4	TWO-SHEAR RAM <sup>12</sup>	10	5	-
A SPECIAL PRIZE of 10l. 10s. for the best Jersey Bull. <sup>7</sup>				SHEARLING RAM.	10	5	3
<b>GUERNSEY.<sup>8</sup></b>				FIVE SHEARLING RAMS <sup>12</sup> .	15	10	5
BULL, calved 1903, '04, '05, or '06.	10	6	-	SELLING CLASS FOR SHEARLING RAMS <sup>12</sup> .	10	5	3
BULL, calved in 1907.	10	6	-	THREE RAM LAMBS, dropped in 1908.	10	5	3
COW OR HEIFER, in-milk, calved in or before 1905.	10	6	-	THREE SHEARLING EWES.	10	5	3
HEIFER, calved in 1906.	10	6	-	THREE EWE LAMBS, dropped in 1908.	10	5	3
HEIFER, calved in 1907.	10	6	-				
Milk Yield Prizes.	10	6	4				

<sup>1</sup> £108 provided by the Newcastle Local Committee.  
<sup>2</sup> Offered by the Northumberland and Durham Agricultural Societies.  
<sup>3</sup> £45 provided by the Galloway Cattle Society.  
<sup>4</sup> £20 10s. provided by the Highland Cattle Society.  
<sup>5</sup> Offered by the Ayrshire Cattle Herd Book Society.  
<sup>6</sup> Offered by the English Jersey Cattle Society.  
<sup>7</sup> Offered by the Royal Jersey Agricultural Society.  
<sup>8</sup> £10 provided by the English Guernsey Cattle Society.  
<sup>9</sup> £8 provided by the Longhorn Cattle Society.  
<sup>10</sup> Offered by the English Kerry and Dexter Cattle Society.  
<sup>11</sup> £10 provided by the Oxford Down Sheep Breeders' Association.  
<sup>12</sup> Offered by the Shropshire Sheep Breeders' Association.

Prizes for Cattle and Sheep, 1908.

CXXIX

SOUTHDOWN.				LINCOLN (continued).				
Prizes				Prizes				
	1st	2nd	3rd		1st	2nd	3rd	
	£	£	£		£	£	£	
TWO-SHEAR RAM <sup>1</sup>	10	5	3	THREE SHEARLING EWES	10	5	3	
SHEARLING RAM	10	5	3	THREE EWE LAMBS, dropped	10	5	3	
THREE SHEARLING RAMS	10	5	3	in 1908	10	5	3	
THREE RAM LAMBS, dropped				THREE YEARLING EWES,				
in 1908	10	5	3	shown in their wool <sup>7</sup>	10	5	3	
THREE SHEARLING EWES	10	5	3					
THREE EWE LAMBS, dropped								
in 1908	10	5	3					
HAMPSHIRE DOWN.				LEICESTER. <sup>9</sup>				
TWO-SHEAR RAM <sup>2</sup>	10	5	3	SHEARLING RAM	10	5	3	
SHEARLING RAM	10	5	3	THREE RAM LAMBS, dropped				
THREE RAM LAMBS, dropped				in 1908	10	5	3	
in 1908	10	5	3	THREE SHEARLING EWES	10	5	3	
THREE SHEARLING EWES	10	5	3	THREE EWE LAMBS, dropped				
THREE EWE LAMBS, dropped				in 1908	10	5	3	
in 1908	10	5	3					
SUFFOLK.				BORDER LEICESTER. <sup>10</sup>				
TWO-SHEAR RAM <sup>3</sup>	10	5	3	RAM, TWO SHEAR and upwards	10	5	3	
SHEARLING RAM	10	5	3	SHEARLING RAM	15	10	5	
RAM LAMB, dropped in 1908 <sup>3</sup>	10	5	3	SHEARLING EWE	15	10	5	
THREE RAM LAMBS, dropped				A SPECIAL PRIZE of 20l. for the best				
in 1908	10	5	3	Border Leicester Sheep exhibited by a				
THREE SHEARLING EWES	10	5	3	Tenant Farmer in Northumberland or				
THREE EWE LAMBS, dropped				Durham. <sup>11</sup>				
in 1908	10	5	3	SPECIAL PRIZES of 5l. each for the best				
				Border Leicester Ram and Ewe. <sup>9</sup>				
DORSET HORN.				COTSWOLD. <sup>12</sup>				
SHEARLING RAM, dropped after				SHEARLING RAM	10	5	-	
Nov. 1, 1906	10	5	3	THREE RAM LAMBS, dropped in				
THREE RAM LAMBS, dropped				1908	10	5	-	
after Nov. 1, 1907	10	5	3	THREE SHEARLING EWES	10	5	-	
THREE SHEARLING EWES,				THREE EWE LAMBS, dropped				
dropped after Nov. 1, 1906	10	5	3	in 1908	10	5	-	
THREE EWE LAMBS, dropped								
after Nov. 1, 1907 <sup>4</sup>	10	5	3					
RYELAND.				KENT OR				
RAM, TWO SHEAR and up-				ROMNEY MARSH. <sup>13</sup>	1st	2nd	3rd	4th
wards <sup>5</sup>	10	5	3	TWO-SHEAR RAM	£	£	£	£
SHEARLING RAM	10	5	3	SHEARLING RAM	10	5	3	
THREE SHEARLING EWES	10	5	3	THREE RAM LAMBS,				
				dropped in 1908	10	5	3	2
KERRY HILL. <sup>6</sup>				WENSLEYDALE. <sup>14</sup>				
RAM, TWO SHEAR and upwards	10	5	3	TWO-SHEAR RAM	10	5	3	
SHEARLING RAM	10	5	3	SHEARLING RAM	10	5	3	
THREE SHEARLING EWES	10	5	3	THREE RAM LAMBS, dropped				
THREE EWE LAMBS, dropped				in 1908	10	5	3	
in 1908	10	5	3	THREE SHEARLING EWES <sup>15</sup>	10	5	3	
LINCOLN.				SOUTH DEVON. <sup>16</sup>				
TWO-SHEAR RAM <sup>7</sup>	10	5	3	RAM, SHEARLING and upwards	10	5	-	
SHEARLING RAM	10	5	3	THREE SHEARLING EWES	10	5	-	
FIVE SHEARLING RAMS <sup>7</sup>	15	10	5					
THREE RAM LAMBS, dropped								
in 1908	10	5	3					

- 1 Offered by the Southdown Sheep Society.
- 2 Offered by the Hampshire Down Sheep Breeders' Association.
- 3 Offered by the Suffolk Sheep Society.
- 4 Offered by the Dorset Horn Sheep Breeders' Association.
- 5 Offered by the Ryeland Flock Book Society.
- 6 £26 provided by the Kerry Hill Flock Book Society.
- 7 Offered by the Lincoln Long-Wool Sheep Breeders' Association.
- 8 £18 provided by the Leicester Sheep Breeders' Association.
- 9 Offered by the Northumberland and Durham Agricultural Societies.
- 10 £15 provided by the Society of Border Leicester Sheep Breeders.
- 11 Offered by the Newcastle Farmers' Club.
- 12 £25 provided by the Cotswold Sheep Society.
- 13 £26 provided by the Kent or Romney Marsh Sheep Breeders' Association.
- 14 £15 provided by the Wensleydale Blue-faced Flock Book Association.
- 15 £15 provided by the Wensleydale Sheep Breeders' Association.
- 16 £10 provided by the South Devon Flock Book Association.

CHEVIOT. <sup>1</sup>	Prizes		
	1st	2nd	3rd
	£	£	£
RAM, TWO SHEAR and upwards	10	5	-
SHEARLING RAM	10	5	-
EW, TWO SHEAR and upwards	10	5	-
SHEARLING EW	10	5	-

A SILVER CUP, value 26l., for the best Cheviot Sheep bred in the County of Northumberland.<sup>2</sup>

SPECIAL PRIZES of 5l. each for the best Cheviot Ram and Ewe.<sup>3</sup>

LONK. <sup>4</sup>			
RAM, SHEARLING and upwards	10	5	-
THREE RAM LAMBS, dropped in 1908	10	5	-
THREE SHEARLING EWES	10	5	-

HERDWICK. <sup>5</sup>			
RAM, TWO SHEAR and upwards	10	5	-
SHEARLING RAM	10	5	-
THREE SHEARLING EWES	10	5	-

**WELSH MOUNTAIN.**  
Same as for South Devon.

BLACK-FACED MOUNTAIN. <sup>6</sup>			
RAM, TWO SHEAR and upwards	10	5	-
SHEARLING RAM	10	5	-
RAM LAMB, dropped in 1908	10	5	-
EW, TWO SHEAR and upwards	10	5	-
SHEARLING EW	10	5	-

SPECIAL PRIZES of 5l. each for the best Black-faced Ram and Ewe.<sup>7</sup>

**PIGS (£770 5s.).**

Special Prizes of 5l. each for the best Large White and Middle White Boar and Sow.<sup>8</sup>

Large White <sup>9</sup>	} For Prizes see below.
Middle White <sup>9</sup>	
Tamworth <sup>9</sup>	
Berkshire <sup>9</sup>	
Large Black <sup>9</sup>	
Lincolnshire Curly-Coated <sup>10</sup>	

In each of the above Breeds the following prizes will be given:—

	1st	2nd	3rd
	£	£	£
BOAR, farrowed in 1904, 1905, or 1908	10	5	3
BOAR, farrowed in 1907	10	5	3
BOAR, farrowed in 1908	10	5	3
BREEDING SOW, farrowed in 1904, 1905, or 1906	10	5	3
SOW, farrowed in 1907	10	5	3
THREE SOW PIGS, farrowed in 1908	10	5	3

**POULTRY (£199 15s.).**

A CHALLENGE CUP, value 10l. 10s., for best Bird in the Show.<sup>11</sup>

TWO SILVER MEDALS, for best Male and Female Bird in the Show.<sup>11</sup>

Prizes are offered for the best COCK, HEN, COCKEREL, and PULLET of the following Breeds:—

	£	£	£
Game, Old English	20	10	5
Game, Indian	20	10	5
Game, Black Sumatra	20	10	5

A Special Prize of 20s. for best Bird in above Classes.

Langshan	20	10	5
Plymouth Rock, Barred	20	10	5
Plymouth Rock, other variety	20	10	5
Wyandotte, Gold or Silver Laced	20	10	5
Wyandotte, White	20	10	5
Wyandotte, Partridge	20	10	5
Wyandotte, other variety	20	10	5
Orpington, Buff	20	10	5
Orpington, White	20	10	5

A SILVER SERVIETTE RING, for best White Orpington.<sup>12</sup>

Orpington, Black	20	10	5
Orpington, Jubilee	20	10	5

A SILVER MEDAL and a SILVER SERVIETTE RING, for best Jubilee Orpington.<sup>12</sup>

Orpington, Spangled . . . 20 10 5

A SILVER SERVIETTE RING, for best Spangled Orpington.<sup>12</sup>

Minorca	20	10	5
Leghorn, White	20	10	5
Leghorn, Black	20	10	5
Leghorn, other colour	20	10	5
Andalusian	20	10	5
Dorking, Coloured	20	10	5
Dorking, other variety	20	10	5
Sussex, any variety	20	10	5
Brahma	20	10	5
Cochin	20	10	5
Hamburg	20	10	5
Campine	20	10	5
French, Faverolle	20	10	5
French, other variety	20	10	5

A Special Prize of 20s. for best Bird in above Classes.

**TABLE FOWLS.**

(To be sent and exhibited alive).

PAIR OF COCKERELS or PULLETS, pure-breed	20	10	5
PAIR OF CROSS-BRED COCKERELS or PULLETS	20	10	5

1 £15 provided by the Cheviot Sheep Society.  
 2 Offered through the Newcastle Local Committee.  
 3 Offered by the Northumberland and Durham Agricultural Societies.  
 4 £15 provided by the Lonk Sheep Breeders' Association.  
 5 £15 provided by the Breeders of Herdwick Sheep.  
 6 £25 provided by Breeders of Black-faced Sheep.  
 7 £54 provided by the National Pig Breeders' Association.  
 8 £18 provided by the British Berkshire Society.  
 9 £18 provided by the Large Black Pig Society.  
 10 Offered by the Lincolnshire Curly-Coated Pig Breeders' Association.  
 11 Offered by the Poultry Club.  
 12 Offered by the Variety Orpington Club.



**Prizes for Pigs, Poultry, and Produce, 1908. CXIXI**

	Prizes		
	1st	2nd	3rd
<b>DUCKS.</b>			
<b>DRAKE OR YOUNG DRAKE,</b>			
<b>DUCK OR DUCKLING.</b>	<i>s.</i>	<i>s.</i>	<i>s.</i>
Aylesbury . . . . .	20	10	5
Bouen . . . . .	20	10	5
Indian Runner . . . . .	20	10	5
Any other breed . . . . .	20	10	5

	Prizes	
	1st	2nd
<b>GEESE.</b>		
<b>GANDER AND GOOSE.</b>		
Embsen . . . . .	30	20
Toulouse . . . . .	30	20

	Prizes	
	1st	2nd
<b>TURKEYS.</b>		
Cock . . . . .	30	20
Hen . . . . .	30	20

**PRODUCE (£249 15s.).**

**BUTTER.**  
Box of Twelve 2 lb. Rolls of BUTTER, not more than 1 per cent. salt. 1st 4l., 2nd 2l., 3rd 1l.

2 pounds of FRESH BUTTER, slightly salted, made up in pounds } Four of 2l. each.  
Four of 1l. each.  
Four of 10s. each.

A SILVER CUP, value 10l., for best Exhibit of Butter, the property of an Exhibitor in Northumberland and Durham.<sup>1</sup>

**CHEESE (made in 1908).**

3 Cheeses in each Entry.	Prizes			
	1st	2nd	3rd	4th
CHEDDAR, of not less than 50 lb. each . . . . .	5	3	2	1
COLOURED CHESHIRE, of not less than 40 lb. each . . . . .	4	3	1	-
UNCOLOURED CHESHIRE, of not less than 40 lb. each . . . . .	4	3	1	-
STILTON . . . . .	4	3	1	-
WENSLEYDALE . . . . .	4	3	1	-
DOUBLE GLOUCESTER . . . . .	4	3	1	-
COTHERSTONE . . . . .	4	3	1	-
CLEVELAND <sup>1</sup> . . . . .	3	2	1	-
CHEDDAR TRUCKLE . . . . .	3	2	1	-

	Prizes		
	1st	2nd	3rd
<b>CIDER AND PERRY.</b>			
Oask of CIDER, made 1907 . . . . .	5	3	2
ONE DOZ. CIDER, made 1907 . . . . .	5	3	2
ONE DOZ. CIDER, made before 1907 . . . . .	5	3	2
ONE DOZ. PERRY . . . . .	5	3	2

	Prizes		
	1st	2nd	3rd
<b>WOOL (of 1908 Clip).</b>			
<b>3 Fleeces in each Entry.</b>			
Leicester or Border Leicester . . . . .	3	2	1
Lincoln . . . . .	3	2	1
Kent or Romney Marsh . . . . .	3	2	1
Any other Long Wool . . . . .	3	2	1
Southdown . . . . .	3	2	1
Shropshire . . . . .	3	2	1
Any other Short Wool . . . . .	3	2	1
Welsh . . . . .	3	2	1
Cheviot . . . . .	3	2	1
Scotch . . . . .	3	2	1

**HIVES, HONEY, AND BEE APPLIANCES.**

	Prizes		
	1st	2nd	3rd
<b>Offered by British Bee-keepers' Association.</b>			
Collection of HIVES . . . . .	80	40	20
FRAME HIVE . . . . .	20	15	10
Do. for Cottagers' use . . . . .	20	15	10
HONEY EXTRACTOR . . . . .	15	10	-
OBSERVATORY HIVE (not less than 3 frames) . . . . .	20	15	10
USEFUL APPLIANCES . . . . .	10	-	-

**HONEY.**

For the purposes of Classes for Honey the United Kingdom has been divided into Two Districts:—

1. Counties of Cheshire, Cumberland, Derby, Durham, Hereford, Lancashire, Leicester, Lincoln, Monmouth, Northumberland, Nottingham, Rutland, Salop, Stafford, Warwick, Westmorland, Worcester, Yorkshire, the Isle of Man, Ireland, Scotland, or Wales.
2. Counties of Bedford, Berks, Bucks, Cambridge, Cornwall, Devon, Dorset, Essex, Gloucester, Hampshire, Herts., Hunts, Isle of Wight, Kent, Middlesex, Norfolk, Northampton, Oxford, Somerset, Suffolk, Surrey, Sussex, or Wiltshire.

For each of the above Districts the following four Classes and Prizes, for Honey of any year, have been provided:—

	Prizes		
	1st	2nd	3rd
<b>HONEY.</b>			
12 Sections of COMB HONEY, about 12 lb. . . . .	20	15	10
RUN OR EXTRACTED, LIGHT-COLOURED HONEY, about 12 lb. . . . .	20	15	10
RUN OR EXTRACTED, MEDIUM OR DARK-COLOURED HONEY, about 12 lb. . . . .	20	15	10
GRANULATED HONEY, about 12 lb. . . . .	20	15	10

**MISCELLANEOUS.**

3 Shallow frames of COMB HONEY, for extracting . . . . .	20	15	10
6 Jars of HEATHER HONEY, about 6 lb. . . . .	20	15	10
6 Jars of HEATHER MIXTURE EXTRACTED HONEY, about 6 lb. . . . .	20	15	10
DISPLAY OF HONEY . . . . .	30	20	10
2 lb. of WAX . . . . .	10	7/6	5
3 lb. of WAX, in marketable form, suitable for retail trade . . . . .	10	7/6	5
HONEY VINEGAR, 1 quart . . . . .	7/6	5	-
MEAD, 1 quart . . . . .	7/6	5	-
OTHER PRACTICAL EXHIBITS . . . . .	10	-	-
OTHER SCIENTIFIC EXHIBITS . . . . .	10	-	-

<sup>1</sup> Offered through the Newcastle Local Committee.

**HORSE-SHOEING COMPETITIONS (£30).***(Open to the United Kingdom.)*

CLASS I. Hunters (Wednesday, July 1). CLASS II. Cart Horses (Friday, July 3).  
Prizes in each Class as follows:—1st, 3*l.* 10*s.*; 2nd, 3*l.*; 3rd, 2*l.* 10*s.*; 4th, 2*l.*; 5th, 1*l.* 10*s.*; 6<sup>th</sup>, 1*l.*

A Silver Medal and a Bronze Medal to be competed for by Members of the National Master Farriers' Association.<sup>1</sup>

**PLANS OF FARM BUILDINGS.<sup>2</sup>**

1st Prize, 50*l.*; 2nd Prize, 25*l.*; 3rd Prize, 15*l.*; 4th Prize, 10*l.*

**FARM PRIZES.<sup>3</sup>**

For the best-managed Farms in the Counties of Northumberland and Durham.

*(Open to bonâ-fide Tenant Farmers.)*

CLASS I.—Arable and Grass Farm of 250 and not exceeding 600 acres. 1st Prize, 60*l.*; 2nd Prize, 30*l.*; 3rd Prize, 15*l.* [10 entries.]

CLASS II.—Arable and Grass Farm of 50 and not exceeding 250 acres. 1st Prize, 35*l.*; 2nd Prize, 25*l.*; 3rd Prize, 10*l.* [8 entries.]

CLASS III.—Dairy Farm of 50 acres and upwards. 1st Prize, 50*l.*; 2nd Prize, 25*l.*; 3rd Prize, 10*l.* [4 entries.]

**SHEEP DOG TRIALS<sup>4</sup>—(Open).**

1st Prize, 10*l.*; 2nd Prize, 5*l.*; 3rd Prize, 3*l.*; 4th Prize, 2*l.*; 5th Prize, 1*l.*

**DAIRY COWS AND MILKERS' COMPETITIONS.<sup>4</sup>**

For the best Dairy Cow and Dairy Heifer, in-milk, to be competed for by Tenant Farmers in the Counties of Northumberland and Durham.

CLASS I.—Cow. 1st Prize, 10*l.*; 2nd Prize, 5*l.*; 3rd Prize, 3*l.*; 4th Prize, 1*l.*

CLASS II.—Heifer, in-milk, bred by Exhibitor. 1st Prize, 6*l.*; 2nd Prize, 3*l.*; 3rd Prize, 1*l.*

**MILKERS' COMPETITIONS**, open only to residents in Northumberland and Durham.

CLASS III.—Open to Men over 16 years. 1st Prize, 3*l.* and Gold Medal; 2nd Prize, 2*l.*; 3rd Prize, 1*l.*; 4th Prize, 10*s.*

CLASS IV.—Open to Women over 16 years. 1st Prize, 3*l.* and Gold Medal; 2nd Prize, 2*l.*; 3rd Prize, 1*l.*; 4th Prize, 10*s.*

CLASS V.—Juniors not exceeding the age of 16 years on June 30, 1908. 1st Prize, 3*l.* and Gold Medal; 2nd Prize, 2*l.*; 3rd Prize, 1*l.*; 4th Prize, 10*s.*

**PLUGHING COMPETITIONS.<sup>5</sup>***(Open to the Counties of Northumberland and Durham.)*

Prizes amounting in all to 214*l.*

**HORTICULTURAL EXHIBITION.<sup>5</sup>**

Prizes amounting in all to 250*l.*

**BRASS BAND CONTEST.<sup>5</sup>**

Prizes amounting in all to 117*l.*

**LOCAL CLASSES.<sup>6</sup>***(Continued to the County of Northumberland.)*

For Cattle, Horses, and Sheep.

Prizes amounting in all to 281*l.*

Offered by the National Master Farriers' Association.

<sup>1</sup> Contributed from various sources.

<sup>2</sup> Offered by the Newcastle Local Committee.

<sup>3</sup> Offered by the Northumberland and Durham Dairy and Tenant Farmers' Association.

<sup>4</sup> Offered by the Proprietors of the Newcastle Chronicle.

<sup>5</sup> Offered by the Northumberland Agricultural Society.

## PRINCIPAL ADDITIONS TO THE LIBRARY.

[*The name of the donor, or the mode of acquisition, appears in Italics after the title of each work.*]

- BAILEY, L. H.** *Cyclopedia of American Agriculture.* 2 vols. 8vo. New York, 1907 ..... *Publishers*
- BALDWIN-WISEMAN, W. R.** *Influence and Porosity on the Motion of Sub-Surface Water.* From the Quarterly Journal of the Geological Society. Vol. LXIII. 1907..... *Author*
- BALDWIN-WISEMAN, W. R.** *Flow of Underground Water.* From the Proceedings of the Institution of Civil Engineers. Vol. CLXV. 1905-6 ..... *Author*
- Encyclopædia of Agriculture.** Edited by C. E. Green and D. Young. Vol. I. 8vo. Edinburgh and London ..... *Publishers*

*Flock Books:—*

- Hampshire Down. Vol. XVIII. 8vo. Salisbury, 1907 ..... *Assocn.*
- Kent or Romney Marsh. Vol. XII. 8vo. London, 1907..... *Assocn.*
- Leicester. Vol. XV. 8vo. Hull, 1907 ..... *Assocn.*
- Lincoln Long Wool. Vol. XVI. 8vo. Lincoln, 1907 ..... *Assocn.*
- New Zealand Flock Book. Vols. IV., V., VI. 8vo. Palmerston North Society
- New Zealand Romney Marsh. Vol. II. 8vo. Feilding, N.Z., 1906... *Society*
- Oxford Down. Vol. XIX. 8vo. Oxford, 1907 ..... *Assocn.*
- Shropshire. Vol. XXV. 8vo. Shrewsbury, 1907 ..... *Assocn.*
- Southdown. Vol. XV. 8vo. Lewes, 1906 ..... *Society*
- South Devon. Vol. IV. 8vo. London, 1907 ..... *Society*
- Welsh Mountain. Vols. I. and II. 8vo. Oswestry, 1906-7 ..... *Assocn.*
- Wensleydale Blue-faced. Vol. XVII. 8vo. Hawes, 1906 ..... *Assocn.*
- Wensleydale. Vol. XVIII. 8vo. Hawes, 1907 ..... *Assocn.*

- Guide to the Specimens of the Horse Family (Equidae),** exhibited in Zoology Dept. of British Museum. 8vo. London, 1907.

*Trustees of British Museum*

- HARRIS and MYERS.** *Food for Plants.* New Edition. 8vo. New York ..... *Mr. W. S. Myers*
- HARWOOD, W. S.** *New Creations in Plant Life.* 8vo. New York *Publishers*

*Herd Books:—*

- Ayrshire. Vol. XXX. 8vo. Kilmarnock, 1907..... *Society*
- Coates's. Vol. LII. and Vol. LIII, Part I. (Bulls.) 8vo. London, 1906 ..... *Shorthorn Society*
- Danish Dairy Cattle. Vols. VI.-IX. 8vo. Odense ..... *Mr. Harald Faber*
- Davy's Devon. Vol. XXX. 8vo. Exeter, 1907..... *Society*
- South Devon. Vol. X. 8vo. Totnes, 1906-7 ..... *Society*
- Galloway. Vol. XXVII. 8vo. Dumfries, 1907 ..... *Society*
- English Guernsey. Vols. XXI.-XXIII. 8vo. London, 1905-7 ..... *Society*
- Hereford. Vol. XXXVII. 8vo. Hereford, 1907 ..... *Society*
- Jutland Breed. Vols. X.-XIV. 8vo. Aarhus ..... *Mr Harald Faber*
- English Jersey. Vol. XVIII. 8vo. London, 1906..... *Society*
- Kerry and Dexter. Vol. XIII. 8vo. Dublin, 1907... *Royal Dublin Society*
- Large Black Pig. Vols. V.-VIII. 8vo. Bury St. Edmunds..... *Society*
- Lincolnshire Curly-Coated Pig. Vol. I. 4to. Sleaford, 1907 ..... *Assocn.*

*Herd Books (continued) :—*

Lincolnshire Red Short-horn. Vol. XIII. 8vo. Lincoln, 1907 ..... *Assocn.*  
 Longhorn Cattle. Vol. V. 8vo. Atherstone, 1905..... *Society*  
 Polled (Aberdeen Angus). Vol. XXXI. 8vo. Banff, 1907 ..... *Society*  
 Register of Boars and Sows. Vol. VI. 8vo. Dublin, 1907... *Royal Dublin Society*  
 Sussex. Vols. XX.-XXII. 8vo. London, 1905-7 ..... *Society*  
 Welsh Black Cattle. Vol. I. 8vo. Haverfordwest, 1905 ..... *Society*  
 British Berkshire Pig. Vol. XXIII. 8vo. Abingdon, 1907..... *Society*  
 National Pig. Vol. XXIII. 8vo. Nottingham, 1907 ..... *Assocn.*  
**LUXMOORE, Dr. C. M.** The Soils of Dorset.  
**MARTIN-DUNCAN, T.** Insect Pests of Farm and Garden. 8vo. London, 1906 ..... *Publishers*  
**MARTINEZ, Albert B.** Récensement General de la Ville de Buenos Ayres. 8vo. Buenos Ayres, 1906 ..... *Author*  
**MAYO, N. S.** The Diseases of Animals. 8vo. New York, 1907..... *Publishers*  
**MICHAEL, H. A.** Studies in Plant or Organic Chemistry and Literary Papers. 8vo. Philadelphia ..... *Mr. F. R. Abbott*  
**MILL, Hugh R., D.Sc., LL.D., F.R.S.E.** British Rainfall, 1905. 8vo. London, 1906 ..... *Author*  
**ROBERTSON, F. D. S.** Practical Agricultural Chemistry. 8vo. London ..... *Publishers*  
**SHEPHERD, Edmund T.** Practical Farming. 8vo. London ..... *Author*  
**STIRLING, A. M. W.** Cokc of Norfolk and his Friends. 2 vols. 8vo. London, 1907..... *Publishers*

*Stud-Books :—*

Clydesdale. Vol. XXIX. 8vo. Glasgow, 1907 ..... *Society*  
 Hackney. Vol. XXIV. 8vo. London, 1907 ..... *Society*  
 Hunters' Improvement. Vol. XI. 8vo. London, 1906..... *Society*  
 Jutland Breed. Various Vols. 8vo. Aarhus..... *Mr. Harald Faber*  
 Polo and Riding Pony. Vol. IX. 8vo. Lewes, 1906..... *Society*  
 Shire. Vols. XXVII. and XXVIII. 8vo. London, 1906-7..... *Society*  
 Suffolk. Vol. XV. 8vo. Diss, 1906 ..... *Society*  
**TAYLOR, Samuel, F.S.I.** Inexpensive Rural Cottages. 4to. London... *Author*  
**VOORHEES, E. B.** Forage Crops. 8vo. New York, 1907 ..... *Publishers*

*The Society is indebted to numerous Government Departments, both at home and abroad, to Boards of Agriculture, Agricultural Societies, and kindred institutions, for copies of their Annual Reports, Journals, Proceedings, Transactions, Bulletins, and other documents received regularly for the library in exchange for copies of the Journal, as well as to the Editors of many agricultural and general papers for the current numbers of their publications, which have been placed for reference in the Reading Room.*

## INDEX TO VOLUME 68.

1907.

*of Articles are printed in Italics. The Roman numerals refer to the Appendix.*

## ACR

AGE of Crops, 267  
 under Crops and Grass in 1907,  
 oat, Barley, and Oats in each  
 , 276  
 s to Library, Principal,  
 , cxxxiv  
 ns by Payment at Lincoln  
 96  
 ural and Breed Societies,  
 ence with, 193, xxx, xxxi  
 ural Co-operative Credit  
 es, 87  
 ural Education Association,  
*ural Education Exhibition,*  
 2-161  
 ural Holdings in each Divi-  
 onland, &c., Number of, 279  
*ural Holdings Act, 1906, The,*  
 n Gooseberry Mildew, 225  
 s *Meat Exports*, 81-83  
*Report for 1907 of the Consult-*  
*antist*, 220-229  
 6 of the *Consulting Chemist,*  
 06 of the *Principal of the*  
*Veterinary College*, 201-210  
 6 of the *Zoologist*, 229-241  
 , 201  
 ion, 2  
 d (Charles F.), *Wild Birds,*  
*and Injurious*, 17-32  
 Cultivated Land farmed by  
 is and Owners, 279  
 ace at Lincoln Show, 94  
 Sales in the Showyard, 94  
 of 1907. The, 295  
 Prices of British Corn, 280  
 , Cattle, 281  
 ol, 281  
 of Prizes at Show of 1907, 1v  
 [ Beetle, The, 234  
 nce Sheet, 1907, Ordinary,  
 in Show, xxiv  
 Age of, 268  
 uous Growing of, 250  
 eage of, 268  
 w-fly, 236  
 Cotton Cake, Metal in, 213  
 al, 215  
 ublicerculosis, Transmissibility  
 Man, 208

## CON

Botanist, Annual Report of Consult-  
 ing, 220-229  
 Bray, Prize Farm of Mr. William, 187  
*Breeding and Feeding of Pigs, The,*  
 64-70  
 British Corn, Average Prices of, 280  
 Broad Beans, Injuries to, 226  
 Brodie (F. J.), *The Weather during the*  
*Agricultural Year 1906-1907*, 289-296  
 Burton Herd, History of, 176  
 Butter at Lincoln Show, 116  
 — Colouring of Milk and, 160  
 — Imports of, 287  
 Butter Tests at the Lincoln Show,  
 1907, 143  
 Buttercups in Pasture, 224  
 By-Law, New, 198  
 CABBAGE, Acreage of, 269  
 Cakes and Meals, Compound, 214  
 Cambridge University, Agricultural  
 Department, 155  
 Carrion Crow, The, 21  
 Carruthers (William), *Annual Report*  
*for 1907 of the Consulting Botanist,*  
 220-229  
 Caterpillars, 240  
 Cattle at Lincoln Show, 100  
 — Imported and Exported, Number of,  
 283; to and from Ireland, 285  
 — in Great Britain in 1907, 271  
 — Prices of Fat, 281  
 — Redwater in, 206  
 Celery Fly, The, 238  
 Cheese at Lincoln Show, 117  
 — Imports of, 287  
 — Mites, 232  
 Chemist, Annual Report of Consulting,  
 210-220  
 Cider at Lincoln Show, 117  
 — Lead in, 218  
 Clover, Acreage of, 270  
 Collegiate Exhibits at Lincoln Show,  
 155  
 Colouring of Milk and Butter, 160  
 Committees of Council, Standing, iii  
 Compensation for Damage by Game, 13  
 — for Unreasonable Disturbance, 8  
 Compound Cakes and Meals, 214  
 Compound Manures, 216  
 Conference with Agricultural and  
 Breed Societies, 193, xxx, xxxi  
 Continuous Growing of Wheat, 245  
 — of Barley, 250  
 Conveyance of Harewood House,  
 xxxiii

## CON

- Conveyor Feeder fitted to Threshing Machine, 132  
*Co-operation and Agricultural Credit*, 86-88  
 Co-operative Banking, its Principle and Practice, 88  
 — Pig Dealing, 69  
 Corn, Prices of British, 280  
 — Imports, Quantities and Values of, 282  
 Cotton Cake, 212, 213  
 Council, List of, 1  
 — Meetings in 1907, Minutes of, xxvii  
 Countries from which Wheat and Flour were imported, 282  
 County Councils Association, 160  
 Creams, Weight and Value of, 148  
 Crops and Grass, Acreage under, 274  
 — Produce of, and Yield per Acre, 278  
 Crow, The Carrion, 21  
 Cuckoo, The, 25  
 Cultivated Land farmed by Tenants and Owners, Area of, 279

- D**EAD Meat, Quantities and Values of, 286  
 Death of Mr. Albert Pell, 191, xxxiii  
 Deaths of Governors and Members during year, 191  
 Deleterious Plants, 59  
 Deputation to Railway Clearing House, 193, 194  
 — from Gloucester, 196, xl  
 — from Newcastle, xxix  
 Diseases of Plants, 225  
 Disposal of Harewood House, 193  
 Distribution of Governors and Members of the Society, v  
 — of Prizes at Lincoln Show, xxiii  
 Drone Fly Grubs, 236  
 Duration of Vitality in Farm Seeds, 221

- E**DITOR of Journal, Appointment of, xxxiii  
 Eggs, Imports of, 287  
 Election of Auditors, xlviii  
 — of President for 1908, xlvii  
 Elwes (H. J.), *Report on the Forestry Exhibition at Lincoln*, 1907, 161-166  
 Entries of Live Stock and Implements at Lincoln Show, 93, 94  
 Evens, Prize Farm of Mr. John, 172  
 Exhibits at Lincoln Show, Description of, 96  
 — by Societies at Lincoln Show, 158  
 Experiments in the Dairy, 148  
 Extraordinary General Meeting, xxviii  
 FARM Prize Competition, 1907, 66-190  
 Farm Seeds, Duration of Vitality in, 221  
 Fattening of Cattle, Prices of, 281  
 Fattening of Pigs, 67

## IND

- Feeding Stuffs, 212  
 Fertilisers, 215  
 Field Experiments at Woburn, 242  
 Financial Statement by Chairman of Finance Committee, xvi  
 First Prize Farms in Competition, 172, 183  
 Flour, Countries importing, 282  
 Forestry Exhibition at Lincoln Show, Report on the, 161-166  
 Freedom of Cropping, 5  
 Fruit, Acreage of Small, 269  
 — Imported, Quantity and Value of, 286  
**G**ENERAL Meeting, Report of Council to, December, 1907, 191-200; Proceedings at, xlv  
 — in Showyard, 92; Proceedings at, xxxvi  
 Germination of Seeds, Purity and, 220  
 Glanders, 203  
 Gloucester, Deputation from, 196, xl  
 Governors of the Society, List of, vii  
 — Life, paying an Annual Subscription to the Society's Funds, xiv  
 — Number of, since Establishment of Society, xv  
 Grass Experiments at Woburn, 259  
 Green-manuring Experiment at Woburn, 257  
 Guano, Native, 218  
 Gull, The Black-headed, 30  
 Güssow (H. T.), *Injurious Fodder and Poisonous Plants*, 32-63

- H**ALL (A. D.), *Mangolds running to Seed*, 79-81  
 Harewood House, Disposal of, 193  
 Harris (John M.), *Pigs and Bacon*, 71-78.  
 History of the Burton Herd, 176  
 Hogg, (W. H.), *Farm Prize Competition*, 1907, 166-190  
 Honey, &c., at Lincoln Show, 119  
 Honorary Members of the Society, xxiii  
 Hops, Estimated Total Production of, 279  
 — Imported, Quantity and Value of, 285  
 Horizontal Log Band Saw, 134  
 Horse-shoeing Competitions at Lincoln Show, 119  
 Horses at Lincoln Show, 96  
 — Imported and Exported, Number of, 284; to and from Ireland, 285  
 — in Great Britain in 1907, 271  
 Horticultural Exhibition at Lincoln Show, 90

- I**MPLEMENTS at Lincoln Show, 130  
 Importation of Meat, xlviii  
 Indian Orderly Officers' visit to Lincoln Show, H.M. The King's, 92

## INJ

- Injurious Fodder and Poisonous Plants*, 32-63  
 Ireland, Live (Stock) Imported and Exported, 285;
- JACKDAWS**, 21  
 Jay, The, 22  
 John's Disease, 205  
 Judges at Lincoln Show, li.  
 — of Farm Prize Competition, 168, xxx
- KING** (H.M. The), Visit to Lincoln Show of, 92  
 Kohl Rabi, Acreage of, 269
- LAMP** Pump, 135  
 Land farmed by Tenants and Owners, Area of Cultivated, 279  
 Lead in Cider, 218  
 — In White-washing Paint, 219  
 Library, Principal Additions to, cxxxiii, cxxxiv  
 Life Governors and Members paying an Annual Subscription, xiv  
 Lime Screenings, 218  
*Lincoln Show*, 1907, *The*, 90-120  
 — Receipts and Expenditure at, xxiv  
 Lincolnshire Agricultural Society, Letter from, xliii  
 Linseed Cake, 212  
 List of Council, i  
 — of Samples analysed by Consulting Chemist, 219  
 Live Stock in Great Britain, &c., Number of, 270, 274  
 — in each County, 276  
 Local Classes at Lincoln Show, Awards of, cxviii  
*Lopes, Sir Massey*, 88, 89  
 Lucerne, 258  
 — Acreage of, 269  
 — Varieties of, 269
- MOFADYEAN** (Sir John), *Annual Report for 1907 of the Principal of the Royal Veterinary College*, 201-210  
 McRow (Thomas), *The Lincoln Show*, 1907, 90-120  
 Magpie, The, 21  
*Mangolds running to Seed*, 79-81  
 — Acreage of, 268  
 — Nitrate of Salt and Soda for, 257  
 Manures, Compound, 216  
 — Imported, Quantity and Value of, 288  
 Margarine, Imports of, 287  
 Market Gardeners Compensation Act, 1895, 5  
 Marketing of Pigs, 68  
 Martin, The, 23  
 Mathews (Ernest), *Milk and Butter Tests at the Lincoln Show*, 1907, 138-152  
 Meals, Compound Cakes and, 214  
 Meat Meal for Pigs, 215

## POL

- Meat, Quantities and Values of Dead, 288  
 — Importation of, xlviii  
 Mediterranean Flour Moth, 235  
 Members on Register, xiii  
 — Life, paying an Annual Subscription, xiv  
 — Numbers of, since Establishment of Society, xv  
 Memoranda, xxviii  
 Metal in Bombay Cotton Cake, 213  
 Meteorology at Lincoln Show, 152  
 Midland Agricultural and Dairy College, 157  
 Milk, Imports of, 287  
*Milk and Butter Tests at the Lincoln Show*, 1907, 138-152  
 Milk and Butter, Colouring of, 150  
 Milk-yield Tests, 138  
 Milking Machines, 133  
 Milks, Weights of Various, 150  
 Minutes of Council Meetings in 1907, xxix  
*Miscellaneous Implements exhibited at Lincoln*, 1907, 130-137  
 Molasses Feeding Materials, 214
- NATIONAL** Diploma, Results of Examinations for, in Agriculture, 198, 199; in Dairying, 199, 200  
 Native Guano, 218  
 Newcastle, Deputation from, xxix  
 — Show, Prize List for, cxvii  
 Nightjar, The, 24  
 Nitrate of Soda and Salt for Mangolds, 257  
 Nursery Garden Pests, 236
- OATS**, Acreage of, 268  
 — Officials and Judges at Lincoln Show, li.  
 — of the Society, iv  
 Owners and Tenants, Cultivated Land farmed by, 279
- PAINT**, Lead in White-washing, 219  
 Partridge, The, 30  
 Peas, Acreage of, 268  
 Pell, Death of Mr. Albert, 191, xxxiii  
 Permanent Grass, Acreage of, 270  
 Perry at Lincoln Show, 117  
 Pests infesting Buildings and Stored Produce, 232  
 Pewit, The, 30  
 Pheasants, 29  
*Pigs and Bacon*, 71-78  
 Pigs at Lincoln Show, 112  
 — in Great Britain in 1907, 272  
 — Imported and Exported, Number of, 283; to and from Ireland, 285  
 Pine Shoot Tortrix, 238  
 Plants, Diseases of, 225  
*Pleasure Farming*, 85, 86  
 Poisonous Plants, 38  
 Poley (A. P.), *The Agricultural Holdings Act*, 1906, 1-16

## FF

## POT

- Potatoes, Acreage of, 268  
 — Diseases affecting, 226  
 Pot-culture Experiments at Woburn  
 264  
 Poultry at Lincoln Show, 115  
 — Imports of, 287  
 President for 1908, xxxiii, xlvii  
 Prices of British Corn, 280  
 — of Fat Cattle, 281  
 — of Wool, 281  
 Principal Additions to the Library,  
 cxxxiii, cxxxiv  
 Prize List for Newcastle Show, 1908,  
 cxiv  
 Prizes offered for Farms, 166  
 Proceedings at General Meetings in  
 1907: June 27, xxxvi; December 11,  
 xlv  
 Produce at Lincoln Show, 117  
 Produce returns for 1907, 272  
 — and Yield of Crops in 1907, 278  
 Pump, The Lamp, 135  
 Purity and Germination of Seeds, 220  
 Pygmy Mangold Beetle, 230
- Q**UANTITIES and Values of Imports  
 of Corn, 282  
 — of Fruit, Vegetables, and  
 Hops, 235  
 — of Dead Meat, 286  
 — of Wool, Wood, Seeds, Manures, &c.,  
 288  
 Queen Victoria Gifts Fund, xxxiv
- R**AILWAY Clearing House, Deputa-  
 tion to, 193, 194  
 — Letter from, xli  
 Rainfall of 1907, The, 293  
 — at Woburn, 1907, 264  
 — Temperature and Bright Sunshine  
 in 1907, 292  
 Rape Dust, 217  
 Reduced Railway Fares, xxxviii  
 Redwater in Cattle, 206  
 Repairs to Buildings, 3  
 Report of Council to General Meeting,  
 December, 1907, 191-200  
 Report on the Forestry Exhibition at  
 Lincoln, 1907, 161-166  
 Research Laboratory, 201  
 Resignation of Sir Charles Whitehead,  
 192, xl  
 Results of Butter Tests at Lincoln  
 Show, 144, 145  
 — of Milk Yield Tests at Lincoln  
 Show, 139-141  
 Ringdove, The, 28  
 Rockdove, The, 29  
 Rook, The, 19  
 Root-knot Eelworm, The, 239  
 Rotation Experiments at Woburn, 251  
 — Grasses, Acreage of, 270  
 Royal Agricultural Society's Exhibit  
 at Agricultural Education Exhibi-  
 tion, Lincoln, 1907, 158

## SWI

- Royal Meteorological Society, 152  
 Royal Veterinary College, Annual  
 Report for 1907 of the Principal  
 of the, 201-210
- S**AMPLES analysed by Consulting  
 Chemist, List of, 219  
 Saw, Horizontal Log Band, 134  
 Saw-fly, The, 286  
 Seagulls, 30  
 Second Prize Farms in Competition,  
 179, 187  
 Seed Dresser, 130  
 Seeds, Duration of Vitality in Farm,  
 221  
 — Imported, Quantity and Value of,  
 288  
 — Purity and Germination of, 220  
 Shedding in Implement Yard at  
 Lincoln Show, 94  
 Sheep at Lincoln Show, 107  
 — in Great Britain in 1907, 271  
 — Imported and Exported, Number  
 of, 283: to and from Ireland, 285  
 Show of 1907, 91  
 — of 1908, 195  
 — of 1909, 196  
 Showyard, The Lincoln, 90  
 Side Delivery Rakes at Lincoln, Trials  
 of, 121  
 Snails and Slugs, 241  
 Societies, Exhibits by, at Lincoln Show,  
 158  
 Soot, 217  
 South Eastern Agricultural College,  
 156  
 Spring of 1907, The, 291  
 Standing Committees, iii  
 Starling, The, 19  
 Statements of Ordinary Receipts and  
 Expenditure for 1907, xx  
 — at the Lincoln Show, xxiv  
 — of Prizes, Classes, and Entries at  
 Lincoln Show, 95  
 — showing Distribution of Prizes at  
 Lincoln Show, xxiii  
 Statistics affecting British Agricultural  
 Interests, 286-288  
 Steel Wire Fence, 131  
 Stewards for Lincoln Show, Appoint-  
 ment of, xxx  
 — for Newcastle Show, xlv  
 Stirton (Thomas), Miscellaneous Imple-  
 ments exhibited at Lincoln, 1907, 130-  
 137  
 Stockdove, The, 28  
 Summary of Members on Register, xiii  
 Summer of 1907, The, 294  
 Sunshine of 1907, The, 292  
 Superphosphates, 216  
 Swallow, The, 23  
 Swath Turners at Lincoln, Trials of,  
 121  
 Swedes, Acreage of, 268  
 Swift, The, 24  
 Swine Fever, 204.



## SWI

Swine in Great Britain in 1907, 272  
— Imported and Exported, Number  
of, 283; to and from Ireland, 285

**T**ABLE showing number of  
Governors and Members in each  
year, xv

Temperature of 1907, *The*, 292  
Tenants and Owners, Cultivated Land  
farmed by, 279  
Thanks to Chairman of General Meet-  
ing, xxxix, xlix  
Threshing Machine fitted with Con-  
veyor Feeder, 132  
Toadstools, 225  
Todd, Prize Farm of Mr. John, 179  
Transmissibility of Bovine Tuber-  
culosis to Man, 208  
*Trials of Swath Turners and Side  
Delivery Rakes*, 1907, 121-129  
Trust Funds held by the Society, xxii  
Trustees, List of, i  
Tuberculosis Committee, Formation  
of, 198, xlii  
Turnips, Acreage of, 268  
Turtledove, *The*, 29  
Turton, Prize Farm of Mr. E. J., 183

**V**EGETABLES Imported, Quantity  
and Value of, 285

Veterinary College, Annual Report of,  
201-210

Vice-Presidents, List of, i

Vitality in Farm Seeds, Duration of,  
221

Voelcker (Dr. J. A.), *Annual Report  
for 1907 of the Consulting Chemist*,  
210-220

— *The Woburn Experimental Station  
of the Royal Agricultural Society of  
England*, 242-266

Vote of Thanks to Chairman of  
General Meeting, xxxix, xlix

## ZOO

**W**ALKER (Sir Francis E.), *The  
Trials of Swath Turners and  
Side Delivery Rakes at Lincoln*,  
1907, 121-129

Warburton (Cecil), *Annual Report for  
1907 of the Zoologist*, 229-241

*Weather during the Agricultural Year*,  
1906-1907, *The*, 289-296

Weeds, 222

Weevils, 237

Weight and Value of Creams, 148

Weights of Various Milks, 150

Wheat, Acreage of, 267

— Countries from which Imported, 282

— Continuous Growing of, 245

Whitehead, Resignation of Sir Charles,  
192, xl

White-washing Paint, Lead in, 219

*Wild Birds, Useful and Injurious*,  
17-32

Wilson (W.), *The Breeding and Feed-  
ing of Pigs*, 64-70

Winter of 1906-7, *The*, 289

Woburn Experimental Station, 159

*Woburn Experimental Station of the  
Royal Agricultural Society of Eng-  
land, The*, 242-266

Woburn, Rainfall at, 264

Wood, Imported, Quantity and Value  
of, 288

Wool at Lincoln Show, 118

— Prices of, 281

— Imported, Quantity and Value of,  
288

*Wool Production*, 83-85

**Y**ARBOROUGH, Election as Vice-  
President of Earl of, xl

— Letter from Earl of, xlv

**Z**OOLOGIST, Annual Report of,  
229-241

**PUBLICATIONS OF THE ROYAL AGRICULTURAL SOCIETY OF ENGLAND.  
JOURNAL OF THE SOCIETY.**

Now published annually as an Annual Volume in paper covers of about 500 pages. Free to Members; Price to Non-Members, Ten Shillings.

**TEXT-BOOK ON AGRICULTURE.**

**ELEMENTS OF AGRICULTURE:** a Text-book prepared under the authority of the Royal Agricultural Society of England by W. FREEM, LL.D. 486 pp. with 256 Illustrations. Seventh Edition (36th Thousand), 1905. Price 3s. 6d., bound in cloth.

**FARM ACCOUNT BOOKS.**

No. 1, A DIARY, combining Cash Account with daily record of Farm Transactions. Price 4s.  
No. 2, A FARM ACCOUNT BOOK, showing payments and receipts, and supplying a form of Annual Balance Sheet. Price 5s. 6d. Published for the Society and sold by Messrs. FORSTER, GROOM & Co., Ltd., 15 Charing Cross, London, S.W.

**PAMPHLETS.**

**VETERINARY PAMPHLETS BY PROFESSOR SIR GEORGE BROWN, C.B.:**  
**DENITATION AS INDICATIVE OF THE AGE OF FARM ANIMALS.** Fifth Edition (1908). 64 pp. With 60 Illustrations. Price 1s.  
**ANIMALS OF THE FARM IN HEALTH AND DISEASE.** 72 pp. With 62 Illustrations. Third Edition (1895). Price 1s.  
**THE STRUCTURE OF THE HORSE'S FOOT AND THE PRINCIPLES OF SHOEING.** 24 pp. Fourth and Enlarged Edition (1902). With 12 Illustrations. Price 6d.  
**CONTAGIOUS FOOT ROT OF SHEEP.** 2nd Edition (1905). 24 pp. With 8 Illustrations. Price 1s.  
**OTHER VETERINARY PAMPHLETS:**  
**THE MARE AND FOAL.** By Professor J. WORTLEY AXE, M.R.C.V.S. 58 pp. With 20 Illustrations (1898). Price 1s.  
**THE LAMING PEN.** By HAROLD LEENEY. 2nd Ed. (1908). With 9 Illustrations. Price 6d.  
**PAMPHLETS BY MR. CHARLES WHITEHEAD, F.L.S., F.G.S.:**  
**PRACTICAL HINTS ON FRUIT FARMING.** (1904). With 10 Illustrations. 44 pp. Price 1s.  
**HOP CULTIVATION.** With 13 Illustrations (1893). 48 pp. Price 1s.

**DAIRY PAMPHLETS:**

(Issued under the authority of the Dairy Committee of the Society.)  
**THE PRACTICE OF (a) CHEDDAR, (b) CHESHIRE, AND (c) STILTON CHEESE-MAKING.** Price 2d. each.  
**SIMPLE RULES FOR BUTTER-MAKING.** Revised, 1907. (Sheet.) Price 1d. each, or 5s. per 100. Mounted on card and varnished, to hang up in the Dairy, 6d. each.

**OTHER PAMPHLETS:**

**THE VALUATION OF UNEXHAUSTED MANURES OBTAINED BY THE CONSUMPTION OF FOODS BY STOCK.** By J. AUGUSTUS VOELCKER, M.A., B.Sc., Ph.D., and A. D. HALL, M.A. With 3 Diagrams (1903). 44 pp. Price 1s.  
**PRACTICAL HINTS ON VEGETABLE FARMING.** By JAMES UDALE (1904). With 15 Illustrations. 42 pp. Price 1s.  
**TABLES FOR ESTIMATING DEAD WEIGHT AND VALUE OF CATTLE FROM LIVE WEIGHT.** By the late Sir JOHN B. LAWES, Bart., F.R.S. Price 1s.  
**THE WOBURN EXPERIMENTAL STATION OF THE ROYAL AGRICULTURAL SOCIETY OF ENGLAND.** By J. AUGUSTUS VOELCKER, M.A., B.Sc., Ph.D. Annual Reports on Field, Feeding, and Pot-culture Experiments (1899-1906). Price 1s. each.  
**REPORT ON THE WOBURN POT-CULTURE STATION.** By J. AUGUSTUS VOELCKER, M.A., B.Sc., Ph.D. With 17 Illustrations (1900). 52 pp. Price 2s. 6d.  
**THE MAKING OF THE LAND IN ENGLAND.** By ALBERT PELL. (1899.) 27 pp. Price 6d.  
**THE MANAGEMENT AND PLANTING OF BRITISH WOODLANDS.** By Professor CHARLES E. CURTIS, F.S.I. (1904). With 6 Illustrations. 36 pp. Price 1s.  
**THE CONVERSION OF HOME-GROWN TIMBER.** By ROBERT ANDERSON, F.S.I. (1904). With 4 Illustrations. 28 pp. Price 1s.  
**INSECTS INJURIOUS TO FOREST TREES.** By CECIL WARBURTON, M.A., F.Z.S. (1904). With 7 Illustrations. 16 pp. Price 1s.  
**ORCHARD AND BUSH-FRUIT PESTS AND HOW TO COMBAT THEM.** By CECIL WARBURTON, M.A., F.Z.S. With 12 Illustrations (1902). 20 pp. Price 6d.  
**THE DRYING OF FRUIT AND VEGETABLES.** By J. AUGUSTUS VOELCKER, M.A., B.Sc., Ph.D. With 4 Illustrations (1897). 24 pp. Price 3d.  
**HEDGES AND HEDGE-MAKING.** By W. J. MALDEN. With 10 Illustrations (1890). 32 pp. Price 6d.  
**COTTAGE SANITATION IN RURAL DISTRICTS.** By H. MACLEAN WILSON, M.D., B.Sc. With a Preface by T. PRIDGIN TEALE, F.R.S. Second and Enlarged Edition. 32 pp. 12 Illustrations (1896). Price 3d. per copy; 2s. per doz.; 12s. 6d. per 100.  
**THE AGRICULTURAL HOLDINGS ACT, 1900.** By S. B. L. DRUCE. (1900). 80 pp. Price 6d.

The above can be obtained at the Society's House, 16 Bedford Square, London, W.C. through any bookseller, or of Mr. JOHN MURRAY, 50a Albemarle Street, W. Copies of pamphlets sold at not less than One Shilling each are obtainable by Members of the Society at half-price on direct application to the Secretary.

**COLOURED DIAGRAMS.**

(Obtainable from Messrs. W. & A. K. Johnston, Limited, 7 Paternoster Square, E.C., and Edinburgh.)  
**DIAGRAMS OF INJURIOUS INSECTS.** Drawn from Nature by the late Miss GEORGIANA E. ORMEROD, in conjunction with the late Miss ELEANOR A. ORMEROD, F.R.Met.Soc. Price 1s. 6d. each. Varnished and mounted on canvas, with rollers, 2s. 6d.  
**EIGHT DIAGRAMS REPRESENTING THE LIFE-HISTORY OF THE WHEAT PLANT (after FRANCOIS BAUER).** With Explanatory Pamphlet by W. CARRUTHERS, F.R.S., Consulting Botanist to the Society. Price (including Pamphlet) 10s. per Set of Eight Diagrams.  
**THE POTATO DISEASE.** By W. CARRUTHERS, F.R.S., Consulting Botanist to the Society. Price 1s.



# Royal Agricultural Society of England.

INCORPORATED BY ROYAL CHARTER 26th MARCH, 1840.

PRESIDENT FOR 1908:

THE RIGHT HON. VICTOR CAVENDISH, M.P.

## Terms and Privileges of Membership.

**SUBSCRIPTIONS.**—1. *Annual.*—The minimum subscription of a Governor is £5 and that of a Member £1, due in advance on the 1st of January of each year, and becoming in arrear if unpaid by the 1st of June.

2. *For Life.*—Governors may compound for their subscriptions for future years by paying at once the sum of £50, and Members by paying £15. After payment of ten or more annual subscriptions, a Member may compound for future subscriptions, including that of the current year, by a single payment of £10; and after payment of twenty or more annual subscriptions, by a single payment of £5—or £25 in the case of Governors.

**ELECTION OF NEW MEMBERS.**—Every candidate for admission into the Society must be proposed by a Member, who must specify in writing the full name, occupation, and usual place of residence of the candidate. Forms of proposal may be obtained on application to the Secretary, who will inform new Members of their election by letter.

### PRIVILEGES OF MEMBERSHIP:—

<i>General Privileges</i> , page II.	
<i>Chemical</i> , pages III to V.	<i>Zoological</i> , page VII.
<i>Botanical</i> , pages VI and VII.	<i>Veterinary</i> , page VIII.

The Society at present consists of about 9,700 Members.

All communications as to Membership or on the general business of the Society should be addressed to the Secretary, at 16 Bedford Square, London, W.C.

THOMAS MCBROW,  
Secretary.

16 BEDFORD SQUARE, W.C.  
December, 1907.

Telegraphic Address: "PRACTICE LONDON." Telephone Number: "3675 GERRARD."

## **General Privileges of Governors and Members.**

### **FREE ADMISSION TO SHOWS.**

The Society holds every year an Exhibition of Live Stock, Farm Produce, and Implements, to which, and to the Grand Stands at the Horse Ring, Dairy, and elsewhere, Members are entitled to free admission. The Show of 1908 will be held at Newcastle, from June 30 to July 4.

### **REDUCED RATES FOR ENTRY OF LIVE STOCK AND IMPLEMENTS.**

No entry fee is charged to Members exhibiting Implements at the Shows. Firms and Companies may secure these privileges by the Membership of one or more of their partners. Entries of Horses, Cattle, Sheep, Pigs, Poultry, Produce, &c., can be made by Members at reduced rates.

### **SOCIETY'S JOURNAL AND OTHER PUBLICATIONS.**

Every Member is entitled to receive, without charge, a copy of the Journal of the Society, each Volume of which contains articles and communications by leading authorities on the most important agricultural questions of the day, together with official reports by the Society's Scientific Advisers and on the various departments of the Annual Shows, and other interesting features.

Copies of the Journal may be obtained by Non-Members of the Publisher, Mr. JOHN MURRAY, 50A Albemarle Street, W., at the price of ten shillings per copy. Copies of the Society's pamphlets, sold at not less than One Shilling each, are obtainable by Members at half price on direct application to the Secretary.

### **LIBRARY AND READING ROOM.**

The Society has a large and well-stocked library of standard books on agricultural subjects. A Reading Room is provided, at which the principal agricultural newspapers and other periodicals can be consulted by Members during office hours (10 a.m. to 4 p.m.; Saturdays, 10 a.m. to 2 p.m.).

### **CHEMICAL PRIVILEGES.**

The Society makes annually a considerable grant from its general funds in order that Members may obtain at low rates analyses of feeding stuffs, fertilisers, soils, &c., by the Society's Consulting Chemist (Dr. J. AUGUSTUS VOELCKER, Analytical Laboratory, 22 Tudor Street, London, E.C.). Members may also consult Dr. VOELCKER either personally or by letter at a small fee.

### **VETERINARY PRIVILEGES.**

Members can consult the Professors of the Royal Veterinary College at fixed rates of charge, and they have the privilege of sending Cattle, Sheep, and Pigs to the College Infirmary on the same terms as subscribers to the College.

### **BOTANICAL PRIVILEGES.**

Reports can be obtained by Members from the Society's Consulting Botanist (Mr. W. CARRUTHERS, F.R.S., The Laboratory, 44 Central Hill, Norwood, S.E.) on the purity and germinating power of seeds, and on diseases or weeds affecting farm crops, at a fee of one shilling in each case.

### **ZOOLOGICAL PRIVILEGES.**

Information respecting any animal (quadruped, bird, insect, worm, &c.) which, in any stage of its life, affects the farm or rural economy generally, with suggestions as to methods of prevention and remedy in respect to any such animal that may be injurious, can be obtained by Members from the Society's Zoologist (Mr. CECIL WARBURTON, M.A., The Zoological Laboratory, Cambridge) at a fee of one shilling in each case.

### **GENERAL MEETINGS OF GOVERNORS AND MEMBERS.**

The Annual General Meeting of Governors and Members is held in London during the week of the Smithfield Club Show. A General Meeting is usually held also in the Showyard during the week of the Show.

### **SPECIAL PRIVILEGES OF GOVERNORS.**

In addition to the privileges of Members, as described above, Governors are entitled to an extra copy of each Volume of the Journal, to attend and speak at all meetings of the Council, and are alone eligible for election as President, Trustee, and Vice-President. The minimum Annual Subscription of a Governor is £8, with a Life Composition of £50.

## Governors' and Members' Privileges of Chemical Analysis.

*(Applicable only to the case of persons who are not commercially engaged in the manufacture or sale of any substance sent for Analysis.)*

The Council have fixed the following rates of Charges for Chemical Analysis to Members of the Society.

These privileges are applicable only when the analyses are for *bonâ fide* agricultural purposes, and are required by Members of the Society for their own use and guidance in respect of farms or land in their own occupation and within the United Kingdom.

The analyses are given on the understanding that they are required for the individual and sole benefit of the Member applying for them, and must not be used for other persons, or for commercial purposes.

The analyses and reports may not be communicated to either vendor or manufacturer, except in cases of dispute.

Land or estate agents, bailiffs, and others, when forwarding samples, are required to state the names of those Members on whose behalf they apply.

	<i>£</i>	<i>s.</i>	<i>d.</i>
1.—An opinion on the purity of any Fertiliser or Feeding Stuff (so far as this can be given without detailed analysis) . . . . .	0	1	0
2.—Determination of any <i>one</i> constituent in a Fertiliser or Feeding Stuff . . . . .	0	2	6
3.—Commercial analysis of any ordinary Fertiliser or Feeding Stuff . . . . .	0	5	0
4.—Full Analysis of any compound Fertiliser or Feeding Stuff . . . . .	0	10	0
5.—Analysis of any other material in ordinary use for agricultural purposes . . . . .	0	10	0
6.—Analysis of Milk, Cream, Butter, or other Dairy produce from Members' own farms . . . . .	0	2	6
(N.B.—Samples in any way connected with the Sale of Food and Drugs Acts are not undertaken for analysis.)			
7.—Analysis of Water . . . . .	1	10	0
8.—Analysis of Soil—determination of Lime only . . . . .	0	10	0
9.—Analysis of Soil—partial . . . . .	1	0	0
10.—Analysis of Soil—complete . . . . .	3	0	0
11.—Consultation by letter or personal appointment . . . . .	0	5	0

Together with the analysis will be given, as far as possible, an opinion as to whether an article analysed is worth the price asked for it, or not, provided the cost of the same, together with guarantee (if any) and other particulars relating to the purchase, be given at the time.

All samples and communications, together with fees for analysis, to be addressed to—Dr. VOELCKER, Analytical Laboratory, 22 Tudor Street, London, E.C.

## Instructions for Selecting and Sending Samples for Analysis.

**GENERAL RULES.**—(1.) A sample taken for analysis should be fairly *representative* of the bulk from which it has been drawn.—(2.) The sample should reach the Analyst in the same condition that it was in at the time when drawn.

When Fertilisers are delivered in bags, select four or five of these from the bulk, and either turn them out on a floor and rapidly mix their contents, or else drive a shovel into each bag and draw out from as near the centre as possible a couple of shovelfuls of the manure, and mix these quickly on a floor.

Halve the heap obtained in either of these ways, take one half (rejecting the other) and mix again rapidly, flattening down with the shovel any lumps that appear. Repeat this operation until at last only some three or four pounds are left.

From this fill three tins, holding from  $\frac{1}{2}$  lb. to 1 lb. each, mark, fasten up and seal each of these. Send one for analysis, and retain the others for reference.

Or,—the manure may be put into glass bottles provided with well-fitting corks; the bottles should be labelled and the corks sealed down. The sample sent for analysis can be packed in a wooden box and sent by post or rail.

When manures are delivered in bulk, portions should be successively drawn from different parts of the bulk, the heap being turned over now and again. The portions drawn should be thoroughly mixed, subdivided, and, finally, samples should be taken as before, except that when the manure is coarse and bulky it is advisable to send larger samples than when it is in a finely divided condition.

**Linseed, Cotton, and other Feeding Cakes.**—If a single cake be taken, three strips should be broken off right across the cake, and from the middle portion of it, one piece to be sent for analysis, and the other two retained for reference. Each of the three pieces should be marked, wrapped in paper, fastened up, and sealed. The piece forwarded for analysis can be sent by post or rail.

A more satisfactory plan is to select four to six cakes from different parts of the delivery, then break off a piece about four inches wide from the middle of each cake, and pass these pieces through a cake-breaker. The broken cake should then be well mixed and three samples of about 1 lb. each should be taken and kept in tins or bags, duly marked, fastened, and sealed as before. One of these lots should be sent for analysis, the remaining two being kept for reference. It is advisable also with the broken pieces to send a small strip from an unbroken cake.

**Feeding Meals, Grain, &c.**—Handfuls should be drawn from the centre of half a dozen different bags of the delivery; these lots should then be well mixed, and three  $\frac{1}{2}$ -lb. tins or bags filled from the heap, each being marked, fastened up, and sealed. One sample is to be forwarded for analysis and the others retained for reference.

**Soils.**—Have a wooden box made 6 inches in length and width, and from 9 to 12 inches deep, according to the depth of soil and subsoil of the field. Mark out in the field a space of about 12 inches square; dig round in a slanting direction a trench, so as to leave undisturbed a block of soil and its subsoil 9 to 12 inches deep; trim this block to make it to fit into the wooden box, invert the open box over it, press down firmly, then pass a spade under the box and lift it up, gently turn over the box, nail on the lid, and send by rail. The soil will then be received in the position in which it is found in the field.

In the case of very light, sandy, and porous soils the wooden box may be at once inverted over the soil, forced down by pressure, and then dug out.

**Waters.**—Samples of water are best sent in glass-stoppered Winchester bottles, holding half a gallon. One such bottle is sufficient for a single sample. Care should be taken to have these scrupulously clean. In taking a sample of water for analysis it is advisable to reject the first portion drawn or pumped, so as to obtain a sample of the water when in ordinary flow. The bottle should be rinsed out with the water that is to be analysed, and it should be filled nearly to the top. The stopper should be secured with string, or be tied over with linen or soft leather. The sample can then be sent carefully packed either in a wooden box with sawdust, &c., or in a hamper with straw.

**Milk.**—A pint bottle should be sent in a wooden box.

**GENERAL INSTRUCTIONS. Time for Taking Samples.**—All samples, both of fertilisers and feeding stuffs, should be taken as soon after their delivery as possible, and should reach the Analyst within *ten days* after delivery of the article. In every case it is advisable that the Analyst's certificate be received before a fertiliser is sown or a feeding stuff is given to stock.

**Procedure in the Event of the Vendor wishing Fresh Samples to be Drawn.**—Should a purchaser find that the Analyst's certificate shows a fertiliser or feeding stuff not to come up to the guarantee given him, he may inform the vendor of the result and complain accordingly. He should then send to the vendor *one* of the two samples which he has kept for reference. If, however, the vendor should demand that a fresh sample be drawn, the purchaser must allow this, and also give the vendor an opportunity of being present, either in person or through a representative whom he may appoint. In that case three samples should be taken in the presence of both parties with the same precautions as before described, each of which should be duly packed up, labelled and sealed by both parties. One of these is to be given to the vendor, one is to be sent to the Analyst, and the third is to be kept by the purchaser for reference or future analysis if necessary.

## Suggestions to Purchasers of Fertilisers and Feeding Stuffs.

Purchasers are recommended in all cases to insist on having an **INVOICE**, and to see that such invoice contains the following particulars:—

**In the case of Fertilisers:—**

- (1) The name of the Fertiliser.
- (2) Whether the Fertiliser is artificially compounded or not.
- (3) The minimum analysis of the Fertiliser in respect of its principal fertilising ingredients.

**In the case of artificially prepared Feeding Stuffs for Cattle:—**

- (1) The name of the article.
- (2) The description of the article—whether it has been prepared (a) from one substance or seed, or (b) from more than one substance or seed.

For example:

- (a) An invoice describing an article as "Linseed Cake" implies a warranty that the article is pure, i.e., is prepared from linseed only; "Cotton Cake" (whether decorticated or undecorticated), and "Rape Cake" (for feeding purposes), would come under a similar category.

*Purchasers are reminded that the use of such terms as "95 per cent.," "Oil Cake," &c., affords no security against adulteration. The adoption of the ORDER FORM issued by the Society is therefore strongly recommended.*

- (b) In the case of a Compound Cake or Feeding Stuff, a Vendor is only compelled by the Fertilisers and Feeding Stuffs Act of 1893 to state that it is prepared from more than one substance, and he is not required to specify the particular materials used in its preparation. Purchasers are recommended, therefore, to buy Mixed Feeding Cakes, Meals, &c., with a guaranteed analysis. Any statements in the invoice as to the component parts of such Mixed Cake or Meal will take effect as a warranty, as also will any statements in an invoice, circular or advertisement as to the percentages of nutritive and other ingredients in any article sold for use as food for cattle.

Members of the Society are strongly recommended not only to see that the invoices given to them accurately describe the goods they have ordered, but to make all their orders subject to the Analysis and Report of the Consulting Chemist of the Royal Agricultural Society of England. Copies of a Form of Order for this purpose may be obtained on application to the Secretary.

Attention is particularly directed to the recommendations below as to the qualities of Fertilisers and Feeding Stuffs which purchasers should demand.

## Conditions of Purchase and Sale.

### FERTILISERS.

**Raw Bones, Bone-meal, or Bone-dust** to be guaranteed "PURE," and to contain not less than 45 per cent. of Phosphate of Lime, and not less than 4 per cent. of Ammonia.

**Steamed or "Degelatinised" Bones** to be guaranteed "PURE," and to contain not less than 55 per cent. of Phosphate of Lime, and not less than 1 per cent. of Ammonia.

**Mineral Superphosphate of Lime** to be guaranteed to contain a certain percentage of "Soluble Phosphate." [From 26 to 28 per cent. of Soluble Phosphate is an ordinarily good quality.]

**Dissolved Bones** to be guaranteed to be "made from raw bone and acid only," and to be sold as containing stated minimum percentages of Soluble Phosphate, Insoluble Phosphates, and Ammonia.

**Compound Artificial Manures, Bone Manures, Bone Compounds, &c.**, to be sold by analysis stating the minimum percentages of Soluble Phosphate, Insoluble Phosphates, and Ammonia contained.

**Basic Slag** to be guaranteed to be sufficiently finely ground that 80 to 90 per cent. passes through a sieve having 10,000 meshes to the square inch, and to contain a certain percentage of Phosphoric Acid or its equivalent in Phosphate of Lime. [The highest grades range from 17 to 20 per cent. of Phosphoric Acid; medium grades 14 to 16 per cent.; and low grades from 10 to 12 per cent. of Phosphoric Acid.]

**Peruvian Guano** to be described by that name, and to be sold by analysis stating the minimum percentages of Phosphates and Ammonia.

**Sulphate of Ammonia** to be guaranteed "PURE," and to contain not less than 24 per cent. of Ammonia.

**Nitrate of Soda** to be guaranteed "PURE," and to contain 95 per cent. of Nitrate of Soda.

**Kainit** to be guaranteed to contain 23 per cent. of Sulphate of Potash.

All Fertilisers to be delivered in good and suitable condition for sowing.

### FEEDING STUFFS.

**Linseed Cake, Cotton Cake (Decorticated and Undecorticated), and Rape Cake (for feeding purposes)** to be pure, i.e., prepared only from the one kind of seed from which their name is derived; and to be in sound condition. The Report of the Consulting Chemist of the Royal Agricultural Society of England to be conclusive as to the "purity" or otherwise of any feeding stuffs.

**Mixed Feeding Cakes, Meals, &c.**, to be sold on a guaranteed analysis, to be sound in condition, and to contain nothing of an injurious nature, or ingredients that are worthless for feeding purposes.

## Members' Botanical Privileges.

The Council have fixed the following rates of charge for the examination of Plants and Seeds by the Society's Consulting Botanist.

The charge for examination must be paid at the time of application, and the carriage of all parcels must be prepaid.

- 1.—A report on the purity, amount, and nature of foreign materials, the perfectness and germinating power of a sample of seed . . . 1s.
- 2.—Determination of the species of any weed or other plant, or of any epiphyte or vegetable parasite, with a report on its habits, and the means for its extermination or prevention . . . . . 1s.
- 3.—Report on any disease affecting farm crops . . . . . 1s.
- 4.—Determination of the species of a collection of natural grasses found in any district, with a report on their habits and pasture value . . . 5s.

*N.B.—The Consulting Botanist's Reports on Seeds are furnished to enable Members—purchasers of seeds and corn for agricultural or horticultural purposes—to test the value of what they buy, and are not to be used or made available for advertising or trade purposes.*

### PURCHASE OF SEEDS.

The purchaser should obtain from the vendor, by invoice or other writing, the proper designation of the seeds he buys, with a guarantee of the percentage of purity and germination, and of its freedom from ergot, and, in the case of clover, from the seeds of dodder and broom-rape.

It is strongly recommended that the purchase of *prepared mixtures* of seeds should be avoided. The different seeds should be purchased separately and mixed by the farmer. Mixtures cannot be tested for germination:

Copies of an "Order Form and Conditions of Purchase and Sale of Seeds" may be obtained by Members on application to the Secretary, at 16 Bedford Square, London, W.C.

### THE SAMPLING OF SEEDS.

The utmost care should be taken to secure a fair and honest sample. This should be drawn from the bulk delivered to the purchaser, and not from the sample sent by the vendor.

When legal evidence is required, the sample should be taken from the bulk, and placed in a sealed bag in the presence of a witness. Care should be taken that the sample and bulk be not tampered with after delivery, or mixed or brought in contact with any other sample or bulk.

At least one ounce of grass and other small seeds should be sent, and two ounces of cereals and the larger seeds. When the bulk is obviously impure, the sample should be at least double the amount specified. Grass seeds should be sent at least four weeks, and seeds of clover and cereals two weeks before they are to be used.

The exact name under which the sample has been sold and purchased should accompany it.



## Members' Botanical Privileges—*continued.*

### REPORTING THE RESULTS.

The Report will be made on a schedule in which the nature and amount of impurities will be stated, and the number of days each sample has been under test, with the percentage of the seeds which have germinated.

"Hard" clover seeds, though not germinating within the time stated, will be considered good seeds, and their percentage separately stated.

The impurities in the sample, including the chaff of the species tested, will be specified in the schedule, and only the percentage of the pure seed of that species will be reported upon; but the REAL VALUE of the sample will be stated. The Real Value is the combined percentages of purity and germination, and is obtained by multiplying these percentages and dividing by 100; thus in a sample of Meadow Fescue having 88 per cent. purity and 95 per cent. germination, 88 multiplied by 95 gives 8,360, and this divided by 100 gives 83.6, the Real Value.

### SELECTING SPECIMENS OF PLANTS.

When a specimen is sent for determination, the whole plant should be taken up and the earth shaken from the roots. If possible, the plants must be in flower or fruit. They should be packed in a light box, or in a firm paper parcel.

Specimens of diseased plants or of parasites should be forwarded as fresh as possible. They should be placed in a bottle, or packed in tinfoil or oil-silk.

All specimens should be accompanied with a letter specifying the nature of the information required, and stating any local circumstances (soil, situation, &c.) which, in the opinion of the sender, would be likely to throw light on the inquiry.

Parcels or letters containing seeds or plants for examination (carriage or postage prepaid) must be addressed to Mr. W. CARRUTHERS, F.R.S., The Laboratory, 44 Central Hill, Norwood, London, S.E.

## Members' Zoological Privileges.

The Council have fixed the charge of 1s. for information respecting any animal (quadruped, bird, insect, worm, &c.) which, in any stage of its life affects the farm or rural economy generally, with suggestions as to methods of prevention and remedy in respect to any such animal which may be injurious.

In inquiries concerning injuries, specimens of the injury done should accompany the animal supposed to cause it.

All specimens should be sent in tin or wooden boxes, or in quills, so as to prevent injury in transmission, and must be accompanied by the prescribed fees.

Parcels or letters containing specimens (carriage or postage paid) must be addressed to Mr. CECIL WARBURTON, M.A., Zoological Laboratory, Cambridge.

## Members' Veterinary Privileges.

### I.—ADMISSION OF SICK OR DISEASED ANIMALS TO THE ROYAL VETERINARY COLLEGE.

1. Members of the Society have all the privileges of subscribers to the Royal Veterinary College, Camden Town, N.W., so far as the admission for treatment of Cattle, Sheep, and Swine is concerned, without being called upon to pay the annual subscription to the College of two guineas. The charges made by the College for keep and treatment are as follows :—Cattle, 10s. 6d., and Sheep and Pigs, 3s. 6d. per week for each animal.

2. The full privileges of subscribers, including the examination of horses, and the admission of horses and dogs into the College Infirmary for surgical or medical treatment, on payment of the cost of keep, will be accorded to Members of the Society on payment of a subscription to the College of one guinea instead of two guineas per annum.

### II.—FEES FOR CONSULTATIONS, ANALYSES, AND EXAMINATIONS AT THE ROYAL VETERINARY COLLEGE.

The following fees are payable by Members of the Society for services performed at the Royal Veterinary College on their behalf in cases where a visit to the locality is not involved :—

	£ s. d.
Personal consultation with a Veterinary Professor . . . . .	0 10 6
Consultation by letter . . . . .	0 10 6
Post-mortem examination of an animal, and report thereon . . . . .	1 1 0
Chemical Examination of viscera for any specified metallic poison . . . . .	0 10 6
Chemical Examination of viscera for metallic poisons . . . . .	1 0 0
Chemical Examination of viscera for vegetable poisons . . . . .	1 0 0
Chemical Examination of viscera complete, for metals and alkaloids . . . . .	2 0 0
(The above fees do not apply to cases which involve a visit to the locality.)	

### III.—INVESTIGATION OF OUTBREAKS OF DISEASE AMONG FARM STOCK.

1. In the event of an outbreak of disease among Cattle, Sheep, or Swine occurring on the farm of any Member of the Society, application should at once be made to the Principal of the Royal Veterinary College, Camden Town, London, N.W.

2. The Principal will then instruct an officer of the College to inquire into the outbreak and report to him. He will also fix the amount of remuneration to be paid to the Inspector, whose professional fee will in no case exceed two guineas per day, exclusive of the actual cost of travelling and maintenance.

3. When it appears on the report of the Inspector selected that the outbreak was of an important character, or of general interest, the cost of the investigation will be defrayed by the Royal Veterinary College.

4. An annual grant is made by the Society to the Royal Veterinary College in aid of the further development of Cattle Pathology. In order to assist the authorities of the College in making the necessary investigations, Members of the Society are particularly requested to send to the College any diseased animals (cattle, sheep, or swine) which they would otherwise destroy as useless, and also any specimens of diseased parts of an unusual character. In the event of living animals being sent, it will be necessary to telegraph to the College at Camden Town the time of their arrival at a London station, so that a van may be sent to meet them. The expense of transit will be defrayed by the Royal Veterinary College.

[This Form may be torn out, and when filled up and signed should be forwarded to the Secretary of the Society at 18 Bedford Square, London, W.C.]

# Royal Agricultural Society of England.

## APPLICATION FOR MEMBERSHIP.

I .....

of .....

in the county of .....

am desirous of becoming a Member<sup>o</sup> of the Royal Agricultural Society of England, and engage, when elected, to pay an Annual Subscription of £†

and to conform to the Rules and Regulations of the Society until the termination of the year in which I shall withdraw from it by notice, in writing, to the Secretary.

(Signature) .....

Date .....

Nominated by .....

Elected at the Council Meeting held on .....

..... Secretary.

† The Council trust that all Members who are disposed to give a larger annual Subscription than the minimum of £1 prescribed by the By-laws will be kind enough to do so, in order that the Society's operations may be maintained.

THE SECRETARY,  
ROYAL AGRICULTURAL SOCIETY OF ENGLAND,  
16 BEDFORD SQUARE,  
LONDON, W.C.

**THE VULCAN "PATENT"  
SANITARY**    ♣   ♣   ♣

**Railway Milk Can**

MADE TO MEET THE . . .  
BOARD OF AGRICULTURE'S REQUIREMENTS.

**Patent  
Dust and**

**Water  
Proof Lids.**



**DUST PROOF.**

**WATER PROOF.**

**Sizes : 6, 8, 10, 12, 15, 17 and 20 gallons.**

Write at once for Price Lists, and place order to avoid disappointment.

MAKERS—

**S. J. & E. FELLOWS, LTD.,  
WOLVERHAMPTON.**

Telegraphic Address : "VULCAN, WOLVERHAMPTON."    Telephone No. 379.

EVERYTHING OF THE BEST FOR THE DAIRY.



Type B.

Capacities, 17 to 100 galls. per hour.

## The "LISTER"

BRITAIN'S  
BEST  
SEPARATOR.

GUARANTEED . . .  
A PERFECT SKIMMER,  
Durable, and  
Easy to Work and Clean.

*A High Grade Machine at a Low  
Price. English-made through-  
out.*

SENT ON FREE TRIAL.

## LISTER'S "IDEAL" CHURNS & BUTTERWORKERS



*Made in several Grades.  
All sizes in Stock.*

UNEQUALLED  
for VALUE  
and QUALITY.

*Stocked by most Implement  
Agents, whose Names,  
with Price Lists, &c.,  
will be forwarded on  
application to the  
Makers:—*

**R. A. LISTER & CO., Ltd., Dursley.**

**Agricultural  
Establishment  
and Mills.**

**RAYNBIRD & CO.,  
LTD.**

Chief Office—BASINGSTOKE, HANTS.

London Address—26, SEED MARKET, MARK LANE, LONDON, E.C.

**SEED GRAIN & SEEDS**

Of every description. Quality unsurpassed.

*Samples and Price Lists Post Free on application.*

PRIZE MEDALS at the Great International Exhibitions for the "EXCELLENCE of their SEED CORN and for AGRICULTURAL SEEDS.

**FARM PRODUCE AGENTS.**

**V<sub>1</sub> FLUID**

THE MARVELLOUS WINTER SPRAY

Kills all the eggs of Insects, and the Spores of Fungi, ensuring

**Clean and Healthy Trees and  
Abundant Crops of Fine Fruit.**

Price 10/6 Per Gall.

(Sufficient for 100 Gallons of Spray Mixture.)

**V<sub>2</sub> FLUID For Summer Spraying**

Kills Aphis, Psylla and Scale Insects, without injury to leaf or blossom.

Price 8/6 Per Gall.

(Sufficient for 100—150 Gallons of Spray Mixture.)

*Write for Booklet—Y*

**Wm. Cooper & Nephews, Berkhamsted.**



*Enamelled and  
Aluminium Brawn  
Tins.*

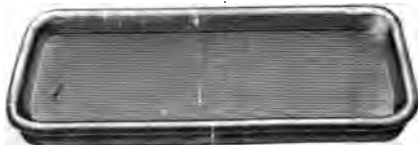

*Special Line—Enamelled Dishes (China Pattern).  
Half the cost of China Dishes, all sizes in stock.*



*Seamless Heavy Lard Pan with  
Ring on Bottom.  
Write for Illustrated Price List.*

Manufacturer of Lard Pans, Brawn Tins, Lard, Beef, Bread and Tongue Pressers, Cleavers, Saws, Knives, Paste Jiggers, Gaudies' Pie Machines, Gaudies' and Hunt's Pie Tins, Enamelled Pie Dishes, Lard Pans, Brawn Tins, Moulds, A-la-Mode Beef Tins, &c. 100 Gross in Stock. Bloor's Patent Pie Meat and Fat-cutting Machines. Will cut 4,000 lbs. per hour. Cut and mix same time. Bloor's Patent Paste Rollers.

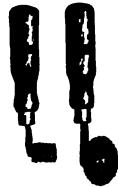

*Paste Jiggers.*

**R. D. D. HETHERINGTON, 187, MOSELEY ROAD, BIRMINGHAM.**

# IMPROVED STABLE FITTINGS

FOR .

Race Horses,

Hunters,

Carriage Horses,

Farm and Cart

Horse Stables.



Catalogues and Estimates on  
Application.



Royal Lancashire Agricultural Show, Bolton, August, 1907.

**J. MARSDEN & CO.** BRITANNIA FOUNDRY,  
BOULTON, LANC.



"THE"  
**"PEDIGREE"**  
**BARLEY, OATS, and WHEAT.**

(CHEVALIER)      (BLACK TARTARIAN.)      (OLD RED. GOLDEN DROP.)  
 (WHITE CANADIAN.)      (HUNTERS. VICTORIA.)

Re-started each year for 48 years from the  
 proved Best Single Grain of the Year.

**Special Prices for Large Quantities.**

CARRIAGE PAID to STATION in ENGLAND and WALES, PORTS of  
 GLASGOW and LEITH, and certain PORTS in IRELAND.

*Pamphlets and further particulars of*

**MAJOR HALLETT,  
 BRIGHTON.**

**SEEDS! TREES!!**

Little & Ballantyne,  
 NURSERYMEN & SEEDSMEN  
 To the King,  
**CARLISLE.**

Catalogues and all Information Free.

**PUMPS**

*For every Service on Estates,  
 &c.*

*Hand or power driven, and for dealing with  
 varying quantities of muddy and sandy water, sewage  
 from cesspits, &c.; also for irrigation, water supply,  
 and fire purposes. Illustrated Catalogue of  
 Estate and Farm Appliances post free.*

**PHENIX ENG. CO.,  
 CHARD,  
 ENGL.**

**PIGS FOR BACON.**

**CHAS. & THOS. HARRIS & CO., Ltd., Bacon Curers, Calne, Wilts,**

Are always open to buy prime quality pigs from 6 sc. 10 lbs. to 10 sc. 10 lbs.

Price and Terms on Application. Killings every Day. Cheques posted on Day of Killing.  
 Kindly mention this Journal.

**McCALLUM Bros.** Auctioneers & Livestock Salesmen,  
 DINGWALL & INVERGORDON, N.B.

Sales of Fat and Store Cattle every Wednesday at 12 o'clock noon. The Largest  
 Sales of Store Stock in the North of Scotland.

Commissions for all classes of Stock will have the firm's best attention.

# Hunter's Guaranteed Grass . . . . Seeds

ARE

the BEST & CHEAPEST.

Purity, Genuineness, and Germination  
Guaranteed. Compare Prices and Guarantee  
before buying elsewhere.

Price List of Farm Seeds, and Treatise  
on Permanent Pasture Grasses free.

**JAMES HUNTER, LTD., CHESTER.**



By Appointment.

## *HIGH-CLASS SEEDS.*

**JOHN K. KING & SONS,**

**GRASS SEEDS**

Have an established reputation of 115  
years.

**ROOT SEEDS**

Are Grown on their own Seed Farms.

**SEED CORN**

Are of Guaranteed Germination and  
Purity.

**CLOVER SEEDS**

Are Moderate in Price.

**GARDEN SEEDS**

Carriage Free.

Descriptive Catalogue and Special Estimates, post free.

## **JOHN K. KING & SONS**

Seedsman to H.M. The King by Royal Sealed Warrant,

**COGGESHALL, ESSEX, also READING, BERKS.**



**No. 2 Size Brick Machine, with 20 in. dia. Roller Mill, and Hand Power Cutting-off Table. . £176 0 0**

**THE OUTPUT IS 7,000 TO 12,000 BRICKS PER DAY.**

—**BENNETT & SAYER, Engineers, DERBY.**—

# RUSSELL'S Patent "HERALD" Range



is the most perfect and economical Cooking Range at present in existence. It contains many patented improvements not in any other Range.

It has been in use for years in many of the principal Residences in the Country.

Send for Catalogues giving full particulars of the various qualities made.

TESTIMONIAL from FRAULEIN NOEDEL, Lady Superintendent to H.R.H. the Princess of Wales' Technical School, Sandringham.

"SANDRINGHAM, NORFOLK,  
September 22, 1901.

"Sirs,—After using the 'Herald' Range in H.R.H. the Princess of Wales' School of Cookery for more than a year, I have pleasure in testifying to its thorough efficiency in every way. It uses comparatively little fuel, keeps pots boiling on every part of the hot plate, the ovens bake well, and it also supplies us with plenty of hot water.—Believe me, Sirs, yours truly,

"CHARLOTTE NOEDEL,

"Lady Superintendent to H.R.H. the Princess of Wales' Technical School."

**RUSSELL'S Patent**

## "PEVERIL"

### Register Stoves and Interiors

are the most powerful Heating Stoves made. There are no Front Bars to prevent the Radiation of Heat.

Send for Catalogues.

OUR PATENT COOKING RANGES  
AND STOVES ARE SUPPLIED BY  
NEARLY ALL IRONMONGERS.

WE HAVE AGENTS IN EVERY  
TOWN.



SOLE MAKERS AND PATENTEES:

**R. RUSSELL & SONS, Ltd.,** PEEL FOUNDRY, DERBY.

# THE ECLIPSE MILK FILTER

(PATENT).

Awarded Prize Medal, Dairy Show, 1907.



- A Inner Gauze.
- B Outlet Gauze.
- C Inverted Bottom.
- D Regulator.

This new invention supplies a long felt want amongst Dairymen and Farmers generally, as it supplies a PERFECT FILTER at a little cost. There are no costly replacements, and it is most easy to clean. The milk passes from the inner bowl through the brass gauze A, and then rising passes out through the finer gauze B, the sediment settling in the recess provided by the inverted bottom C. The regulator D keeps all pressure off the inner gauze. By this process every particle of sediment is taken out of the milk.

**PRICES.**

10 in. diam.	... ..	5s. 0d. each
11 in. " to fit Railway Churns	... ..	5s. 6d. "
12 in. " " " "	... ..	6s. 6d. "

Sole Maker and Patentee—

**T. GRAYSON, Dairy Utensil Works,  
Queen Street, DERBY.**

## KELL & CO., LTD., GLOUCESTER.

THE  
"JOHN  
BULL"  
CORN  
DRILL.



THE  
"JOHN  
BULL"  
CORN  
DRILL.

Corn Drills. Corn and Manure Drills.  
Turnip and Mangold Drills. Hand Drills. Broadcast  
Seed Drills. Broadcast Manure Distributors.

Catalogue and Prices—

**KELL & CO., LTD., DRILLWORKS, GLOUCESTER.**

Telegrams: "TETT," Faversham.

Telephone: 019.

**SCIENTIFIC FRUIT TREE SPRAYING,**  
WINTER and SUMMER.

WRITE  
FOR  
CATALOGUE.

**SPRAY YOUR FRUIT TREES & HOPS**  
using MACHINES manufactured and sold by  
**HENRY S. TETT & Co., Limited,**  
10 & 11, Market Street, FAVERSHAM.

SOLE  
AGENTS  
IN  
KENT  
MARTIN'S  
CULTIVATOR.

Also 61, HIGH STREET, SITTINGBOURNE.

PRESTON WORKS, FAVERSHAM.



**MACHINES AND APPLIANCES FOR HOP AND FRUIT CULTURE**  
A SPECIALITY. —

Being in the centre of the East Kent Hop and Fruit District,  
Messrs. Tett have every opportunity of studying requirements,

**SPRAYING MACHINES IN GREAT VARIETY. . .**

SOLE AGENTS IN EAST KENT FOR . . .

**THE SOLAIR KNAPSACK, THE FOUNTAIN WASHER, and many others.**



PURVEYORS TO  
**His Majesty the King.**  
By Appointment.



**WATERLOO ROUND FEEDING CAKES,**

AS SUPPLIED TO  
**HIS MAJESTY THE KING.**

By Appointment.  
The most perfect MIXED FOOD in the Market.

**WATERLOO 97% PURE COTTON CAKES.**

GUARANTEED FROM EGYPTIAN SEED ONLY.

Guaranteed 87 per cent. Purity.

**WATERLOO 97%**



**WATERLOO ROUND 97% PURE LINSEED CAKES.**

THESE CAKES ARE MADE FROM THE  
**BEST LINSEED PROCURABLE.** Each cake contains about 1 pint  
of Pure Linseed Oil.

GUARANTEED 97 PER CENT. OF PURITY.  
To contain about 13 per cent. Pure Linseed Oil. Under about 1/2 per cent. Sand.  
This is the Purest and Best Linseed Cake Manufactured.

**WATERLOO 97% PURE LINSEED CAKES.**

ANGLO SHAPE.

Guaranteed 97 per cent of Purity.

To contain about 12 per cent. Pure Linseed Oil. Under about 1/2 per cent. Sand.  
**MADE FROM FINEST QUALITY LINSEED. THOROUGHLY SCREENED.**

**WATERLOO 97%**

Sold on the contract warranty of the Royal Agricultural Society of England, viz.:—"Guaranteed pure and to be delivered in good condition."

For Samples and Particulars Apply to  
**AYRE BROS., 'THE AVENUE, HULL.**

# FOREST TREES.

Millions in Stock, very cheap.

**Douglas Fir, Europ, and Japan, Larch**

THORN for HEDGES, etc., etc., a Speciality.

Catalogues Free.

LARGEST NURSERIES IN GERMANY.

SHIPMENTS OF 150 MILLIONS of Plants annually.

**J. HEINS' SONS, HALSTENBEK No. 9, near HAMBURG (GERMANY).**

## College of Agriculture and Horticulture.

HOLMES CHAPEL,  
CHESHIRE.

A residential College, standing on its own Farm, and in the centre of one of the finest districts for Dairying, Stock-raising, Potato-growing, and general mixed farming; Staff of seven Lecturers and three Demonstrators. Fully equipped for thorough training in Practical and Scientific Agriculture combined; Course in Estate Management and Forestry; Complete separate Horticultural Course; seven acres of Gardens and Fruit Plantations; Preparations for National Diploma and Surveyor's Institute Examinations.

Prospectus and Particulars on application to

**T. J. YOUNG, F.S.I., Principal.**

# HARRISON, MCGREGOR & Co.,

LIMITED,

MANUFACTURERS OF

THE  
WORLD  
FAMED

## "ALBION"

GRINDING MILLS,

Combined Grinding and (Sent on trial  
Crushing Mills - - - for One  
Month Free).



CHAFF CUTTERS, ROOT . .  
CUTTERS, CORN CRUSHERS,  
OIL CAKE BREAKERS, . . .  
HORSE AND PONY GEARS.

THE  
**'ALBION'**  
Mowers,  
Reapers  
AND  
Binders

ARE THE BEST IN  
THE MARKET.

458 PRIZES,  
GOLD MEDALS,  
CUPS, &c.,  
gained by the  
"ALBION."

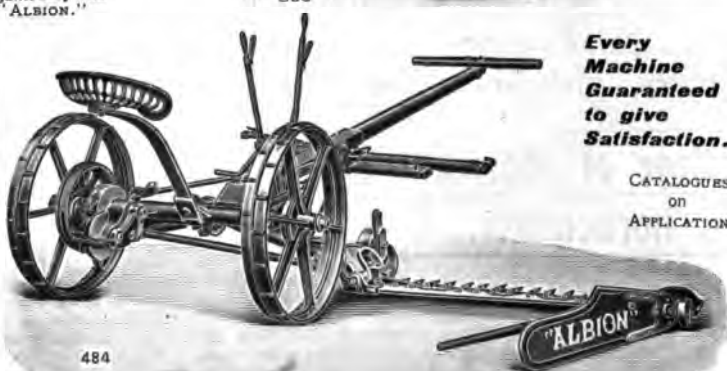

*Every  
Machine  
Guaranteed  
to give  
Satisfaction.*

CATALOGUES  
ON  
APPLICATION.

**ALBION IRON WORKS, LEIGH, Lancashire.**



## DRYAD FURNITURE

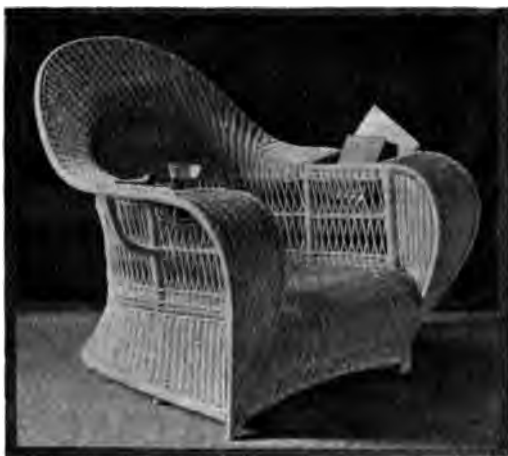

**DRYAD CANE FURNITURE** is not wicker and is quite different from ordinary squeaky furniture in material, beauty, restfulness, and strength. **DRYAD CANE CHAIRS** are designed primarily for comfort, and carefully shaped for this end with cane so woven that cushions are unnecessary. They are made of unbleached pulp cane strengthened with ash, and none but the best workmanship is employed. Their distinctive yet reticent design and colour harmonize well with any good furniture or surroundings, and they are suitable for the garden or drawing-room, billiard-room or study.

*ILLUSTRATED CATALOGUE FREE FROM MAKER.*

**H. H. PEACH, J Dept., 37, Great Central Street, LEICESTER.**

## LEWIS'S KETTERING HORSE HOES.

Made in 11 Sizes.

Prices from £5 10s. to £11. - - Catalogues Free.

These Hoes can also be adapted for moulding up Potatoes, etc., two or three rows at a time.

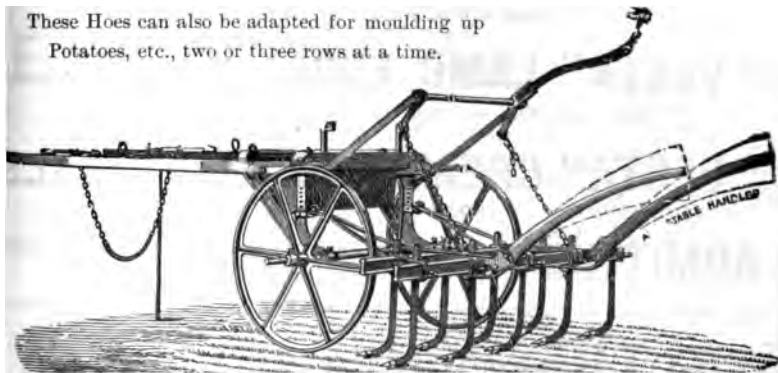

Awarded **PRIZE** by **R.A.S.E.** and many other Societies.

**INDENTS THROUGH MERCHANTS.**

Telegrams--Lewis, Ironworks, Kettering.

Telephone No. 0493.

**LEWIS & SON, Implement Works, KETTERING, ENGLAND.**

# VESTA & MEALS

**T**HE success of The Liverpool Vesta Cake Company's Compound Cakes and Meals is due to the ready digestibility, and consequently, the perfect assimilation of such constituents as Oil, Albuminoids, and Carbo Hydrates, and without any doubt the "Vesta" brand ranks on the market as the typical standard of a Compound Food.

**"VESTA" FATTENING CAKE** 11% Oil.  
21% Albuminoids.

Perfect Cake for Stall Feeding and finishing purposes.

**"VESTA" FEEDING CAKE** 10% Oil.  
20% Albuminoids.

Unsurpassed for Milking and Feeding, also for Young Stock and Sheep.

**"VESTA" GRAZING CAKE** 9% Oil.  
28% Albuminoids.

For Feeding at Grass. Best substitute for Decorticated Cotton Cake.

**"VESTA" DAIRY CAKE** 6% Oil.  
18% Albuminoids.

Gives maximum production of Milk, Butter, and Cheese.

**"VESTA" LAMB FOOD** 8% Oil.  
18% Albuminoids.

Highly palatable and nutritive food for Ewes and Lambs.

**"VESTA" CREAM AND MILK MEALS**

FOR CALF REARING.

**ADMITTED** as giving the maximum of Feeding Value, and as being the most assimilable food on the market.

**The Liverpool Vesta Cake Co.,**

14, 16, 18, Blackstock Street, LIVERPOOL.

Telegraphic Address: "Nutritive, Liverpool"

Telephone No. 5055.

# **E. F. BLAKELEY & CO.,**

Vauxhall Ironworks, LIVERPOOL.



**ROOFS and  
BUILDINGS,  
in  
WOOD and IRON.  
HAY SHEDS,  
CHURCHES,  
SCHOOLS,  
PRINCIPALS.**

TELEPHONE 7977.

TELEGRAPHIC ADDRESS: "CORRUGATED, LIVERPOOL."

## **H. & E. M'GRATH,**

CATTLE SHEDS.

OFFICES:

Milford Street, Liverpool.

Gt. Howard St., Liverpool.

**HAY & PROVENDER  
— DEALERS. —**

**LIVE STOCK SHIPPING AGENTS.**

*Every attention given to enquiries from breeders wishing to export animals.  
Shipments made. Insurance effected. Stock well cared for in our own sheds.*

Telegraphic Address: "ANIMALS, LIVERPOOL." Telephone 1963.

*Address Letters to—*

**H. & E. M'GRATH, Milford Street, Liverpool.**

SEVENTH EDITION

(THIRTY-FIFTH THOUSAND)

OF

# Elements of Agriculture

**A TEXT-BOOK**

PREPARED UNDER THE AUTHORITY OF THE

**ROYAL AGRICULTURAL SOCIETY OF ENGLAND.**

By W. FREAM, LL.D.

*Of all Booksellers.*

486 PAGES, WITH 256 ILLUSTRATIONS.

Price THREE SHILLINGS AND SIXPENCE, bound in cloth.

LONDON: JOHN MURRAY, 50A ALBEMARLE STREET, W.

# ARNOLD & SONS.

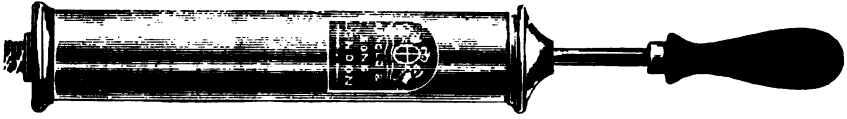

## ENEMA SYRINGES, for Horses, Cattle, &c.

½ pint. 5/6	¾ pint. 7/6	1 pint. 9/- and 10/6	1 quart. 13/6 and 16/-
Best quality, with pipe to fit into piston rod.			
¾ pint. 7/6	1 pint. 10/6	1 pint. 12/6	1 quart. 21/-

## COPPER BULL RINGS.

Thin ... each	9d.
" ... per doz.	8/6
Stout ... each	1/-
" ... per doz.	11/-
" Self Piercing, each	1/9
" " per doz.	20/-

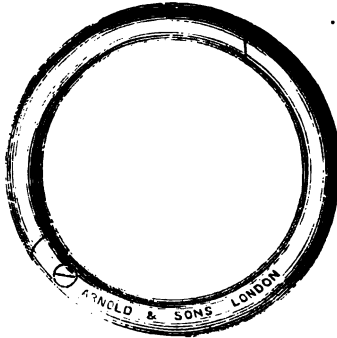

## ALUMINIUM BULL RINGS.

Stout ... each	1/6
" ... per doz.	17/-

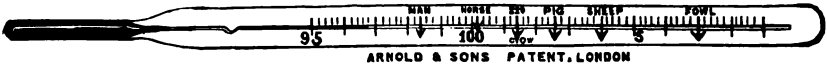

The Animals Thermometer (Patented), suggested by Professor Hobday, in Nickel-plated Case 2/6  
 The Animals Thermometer (Patented), suggested by Professor Hobday, in Nickel-plated Case with Magnifying Index ... 3/6

The above differs from the Thermometer in general use at present, by the fact that arrows are added at intervals on the stem to mark the average normal rectal temperature of each of the domesticated animals and the fowl; in the usual Thermometer the only arrow is placed at 98°4 indicating the normal average of man when taken by the mouth or axilla.

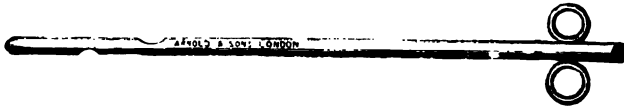

Milking Tubes	- - - - -	1s., 1s. 3d, and 1s. 9d. each.
Do.	do., Self-Retaining	- - - 1s. 6d., and 3s. each.

## ARNOLD & SONS, VETERINARY INSTRUMENT MANUFACTURERS.

BY APPOINTMENT TO

*His Majesty's Government, The Honourable Council of India, Foreign Governments, The Royal Veterinary College, &c., &c.,*

**26, 30 & 31 WEST SMITHFIELD, LONDON. E.C.**

Telegraphic Address—"INSTRUMENTS, London."

ESTABLISHED 1819.

**W. & J. BIGGERSTAFF,**

West Smithfield, London, E.C.,

AND

Woodside Ferry, Birkenhead,

ALSO

AVENIDA DE MAYO 784, BUENOS AYRES.

AGENCIES IN AUSTRALIA AND NEW ZEALAND.

---

**BANKERS AND COMMISSION AGENTS.**

Shipping and Insurance Agents for  
Horses, Cattle, Sheep and Pigs. -  
Special Rates Quoted for Insurance  
of Pedigree Live Stock. - - -

***Cash Advances arranged.***

CURRENT BANKING ACCOUNTS OPENED. £4 PER CENT.  
ALLOWED ON DEPOSITS FOR ONE YEAR.

---

For full particulars as to Insurance Rates, &amp;c., apply to

**W. & J. BIGGERSTAFF,**

West Smithfield,

Telephones—12892 Central.  
869 Holborn.  
Telegrams—Biggerstaff, London.

**LONDON, E.C.**

# DAY, SON & HEWITT'S

NEVER FAILING

## Animal Medicines

Est<sup>d</sup> 1833



TO H.M. THE KING.

Used on the Royal Farms at Windsor, Osborne, Balmoral, and Sandringham, and by Agriculturists everywhere for over 70 years.



For Kicks, Cuts, Bruises, Sore Withers, Swellings, Strains, Saddle Galls, &c. It rapidly relieves Straining and Painful after Calving and Lambing, and is the remedy for Swollen Udders and Sore Teats.

Price 2s. 6d., 3s. 6d., and 7s. per bottle.



A sure remedy for the Fret, Colic, or Gripes Influenza, &c., in Horses. For Debility, Scour or Diarrhoea in Horses, Cattle and Sheep. Hoven or Blown Cattle and Sheep instantaneously relieved.

Price 1s. 9d. per bot., 20s. per doz.



For Colds, Indigestion, Costiveness, Yellows, Surfeits, Loss of Cud, Hide-bound, Red Water, in Cattle and Sheep. Admirably adapted for cleansing Cows and Ewes after Parturition.

Price (Cows), 13s. per doz. box ;  
(Ewes), 3s. 6d. per doz., 3 doz. box 10s.



The only sure cure for Husk, Hoarse, or Cough in Heifers, Calves, Sheep and Lambs; also Tapeworms in Sheep. It allays Bronchial Irritation, destroys and expels the parasites, soothes the lungs, and give strength to overcome the malady.

Price 2s. 9d. per bot., Qt. 10s. 6d., ½ Gal. £1

**Uses:—HORSES.**

- For Blood Disorders, Surfeits, Itching.
- For Anæmia and Skin Affections.
- For Off Appetite and Sluggishness.
- For Weakly Horses and Bad Doers.
- For preparing Horses for Show or Sale.
- For promoting Growth of Bone.
- For Sterility or Barrenness.

**SOLD IN TINS.**

Price 10/6 and 20/- each.  
½ cwt., £2 5s. 0d.

Sold in a highly concentrated Powder form, with measure denoting exact dose. Full instructions sent.



**Uses:—CATTLE & SHEEP.**

- For Impure Blood and Skin Eruptions
- For Humours, Itching and Ringworm.
- For Loss of Cud and Ill Condition.
- For prevention of Abortion.
- For preparing animals for Show or Sale
- For increasing the Growth of Lambs.
- For Sterility of Bulls and Rams.

**SOLD IN TINS.**

Price 10/6 and 20/- each.  
½ cwt., £2 5s. 0d.

Sold in a highly concentrated Powder form, with measure denoting exact dose. Full instructions sent.

**Royal Animal Medicine Manufactory,**  
**12 DORSET ST., LONDON, W. (Est<sup>d</sup> 1833.)**

استشارات للاستشارات

Woods, Moss, Lichen, on Carriage Drives, &c.

**RIDOWEED.**

(Practically Non-Poisonous.)

No. 1. The Safest and Most Powerful

**WEED KILLER.**

The Foresters' and Fruit Growers' Friend.

**SMEAROLEUM.**

No. 1. **Anti-Rodent Smear**, for protecting Young Plantations, Forest, Fruit, and Ornamental Trees, &c., from Rabbits and other Ground Game, Horses, Cattle, Deer, &c.

No. 2. **Insecticide Smear** for Protection of Fruit Trees, &c.

Wire-worm, Slugs, Grubs, &c.

Thomas & Co.'s  
**ARBORITE**

**Anti-Pest FERTILIZER**

The most successful preparation on the market for the eradication of all insect pests from the soil.

The Farm.

**FINGER and TOE** in Turnips, &c.,

destroyed by using

**FINGTOCIDE.**

**GREAT LOSSES** THEREBY SAVED.

THOMAS & Co.'s Preparations are used on the largest Estates in the Kingdom, and in the Parks of His Majesty's Government and the King's Nurseries, and also by the French and American Governments.

Full Particulars, with Directions for Use, and Users' Opinions, on application to the Sole Makers:—

**THOMAS & CO., Ltd., Ceres Works, LIVERPOOL.**

**DISCOVERED BY DR. DANYSZ, of the Pasteur Institute, Paris.**

**The Danysz Virus**

**THE ONLY VIRUS MADE BY THE ORIGINAL DISCOVERER.**

**INFALLIBLY EXTERMINATES**

**RATS**

Mice and other Mouse-like Rodents. It is harmless to other animals and human beings, and no inconvenience need be feared from dead Vermin.

Tubes, 2/6 each; 3 Tubes, 5/-; in bottles (Liquid), 7/6 per quart: cases of 12 bottles, £23 per case, postage or carriage paid with full particulars, testimonials, etc. from—

**DANYSZ VIRUS, Ltd., 52, Leadenhall Street, London, E.C.**  
(Agricultural Dept. 1.)

SPECIAL TERMS FOR LARGER AREAS.

**LAND IMPROVEMENTS.**

Drainage, Farm Buildings, Labourers' Cottages, Artizans' Dwellings, Country Mansions, Water Supply, &c.

**THE GENERAL LAND DRAINAGE & IMPROVEMENT COMPANY.**

INCORPORATED BY ACT OF PARLIAMENT IN 1849.

**DIRECTORS:**

CHAS. G. BOLAM, Esq., *Chairman.* E. P. MORGENTHAU, Esq. | The Hon. CBOLL T. PARKER.  
Surveyor.—Mr. GEORGE NORTH.

This Company advances Money for all purposes of Land Improvement, both Agricultural and General, including the erection of Farm Buildings, Labourers' Cottages, Artizans' Dwellings, and the erection of or additions to Country Mansions, Reclamation of Waste Land, Water Supply, and the formation of Streets and Sewers, &c. If preferred, the Company will execute these Improvements for Landowners by its own Staff.

The outlay and all attendant expenses may be charged upon the estate for any term of years not exceeding 40.

No investigation of title necessary, no notice required to be given either by advertisement or otherwise, and no legal expenses incurred.

Offices of the Company, Palace Chambers, 9, Bridge Street, Westminster, London, S.W.

R. E. HEBBLETHWAITE, *Secretary.*

**BLACKQUARTER OR BLACKLEG.**

This fatal disease in Cattle and Sheep is absolutely preventable by Vaccination with the **Pasteur Vaccines**. Consult your Veterinary Surgeon who will supply pamphlets concerning this most important matter to the Stock raiser.

**RAT-VIRUS.**

An absolute clearance is effected by the use of the "**Pasteur**" Rat-Virus, which infects them with a fatal microbic disease. Perfectly harmless to all other

animals and human beings. Tubes at 2/6 or 3 tubes for 5/-. Large Tube equal to 3 tubes, 5/-.

**ARTIFICIAL INSEMINATION.**

Sterility in Mares, Cows, Ewes, Pigs, Dogs, and other animals effectually obviated and the vitality of the Sire husbanded by the use of The "**Certes**" (Huish Patent) Inseminator. Price 42/-.

Brochure on "The Causes and Remedy for Sterility of Animals" post free Six Stamps. Illustrated Catalogue of Instruments, &c., suitable for Agriculturists, free.

**C. H. HUISH & COY.,**

Surgical Instrument Makers, and Sole Agents for the Pasteur Vaccine Co., Ltd., Paris, &c.,

**12, RED LION SQUARE, LONDON, W.C.**

# INSURE IN-FOAL MARES FOALS AND STALLIONS

WITH THE

**IMPERIAL ACCIDENT INSURANCE COMPANY, Ltd.**

Established 1878.

*Head Offices:* 17, PALL MALL EAST, LONDON, S.W.

The "IMPERIAL" offers **GREATEST BENEFITS** at **LOWEST RATES**.

**Full Market Value Insurable.**

**Foals Insured until expiration of Annual Policies.**

**Full Amount paid for Foal if Cast at any time.**

**Double Amount Payable for Foal after One month old.**

**Large Cash Payment for Barren Mares.**

**UNEQUALLED ADVANTAGES! REDUCED PREMIUMS!**

**STALLIONS INSURED against ACCIDENTS, ILLNESS, and DEATH.**

**FARM and TRADE HORSES INSURED against DEATH.**

**FARMERS' LIABILITY for ACCIDENTS to LABOURERS Insured.**

**CLAIMS PAID, £400,000.**

*Prospectuses, Proposal Forms, and all information post free.*

**AGENTS WANTED.**

**B. S. ESSEX, MANAGER.**

## RATS AND MICE.

It is now recognised by all Estate Owners, that it is their duty to exterminate these rodents. Not only is the loss they cause very considerable, but they spread disease.

**The Board of Agriculture** has reported on experiments conducted with one preparation, viz., **RATIN**.

**Tests** have been made by practically all European Governments, and in this country the Glamorganshire and Somerset Chambers of Agriculture have issued reports on successful experiments made with **RATIN**, and this preparation was recently used on the Little Cumbrae, where every rat succumbed.

**Farmers and Landed Proprietors** are invited to consult us. Write giving extent of Estate and infestation, and full particulars and advice will be sent free by the—

**RATIN LABORATORY,**  
**17, GRACECHURCH ST., LONDON, E.C.**



# PERUVIAN GUANO.

We are offering a wide range of qualities, including the following Cargoes recently arrived:—

OFFICIAL ANALYSIS.			
	Ammonia.	Phosphate.	Potash.
"MIRANDA" . . . . .	10'13 ...	28'70 ...	2'85
"BANKHALL" . . . . .	7'44 ...	30'91 ...	3'30
"WENDUR" . . . . .	7'16 ...	20'35 ...	2'04
"BALMORE" . . . . .	4'97 ...	30'59 ...	3'42
"LADY ELIZABETH" . . . . .	2'92 ...	41'63 ...	2'68

## DISSOLVED (SOLUBLE) PERUVIAN GUANO,

Strongly recommended for Top-dressing, Potatoes, and Fruit Culture.

**GUARANTEED ANALYSIS.**

**Special Manures for all Crops,  
Pure Vitriolised Bones,  
Bone Compounds,  
Superphosphates (26 per cent. and  
higher qualities),  
Nitrate of Soda,  
Bone Meal, Kainit.**

**BASIC SLAG** (Anchor Brand)  
our own grinding.

APPLY TO AGENTS, OR TO

**THE ANGLO-CONTINENTAL GUANO WORKS**

(Late *OHLENDORFFS*),

London Agency—15, LEADENHALL STREET, LONDON.

## A TRUE PLANT FOOD.

The only form of Nitrogen  
that feeds the crop  
**IMMEDIATELY**  
it is applied.



Gives  
immense  
increase in  
**CORN, ROOT,  
GRASS, MARKET  
GARDEN CROPS,  
HOPS, &c.**

*NITRATE can be bought from all leading dealers  
in manures.*

*PAMPHLETS, GRATIS, can be obtained from*

THE  
**PERMANENT NITRATE COMMITTEE,**  
3, Gracechurch Street, LONDON.

## SULPHATE OF AMMONIA

THE **BEST AND CHEAPEST** FORM OF NITROGEN.

Produces — **LARGER CROPS, CROPS OF**

**HIGHER FEEDING VALUE**

**CROPS OF FINER QUALITY**

than can be obtained from  
the use of any other

**NITROGENOUS MANURE**

Pamphlets and Information  
provided Gratis on Application to

**SULPHATE OF AMMONIA**

**COMMITTEE,**

4, FENCHURCH AVENUE,  
LONDON, E. C.

# *The* ST PANCRAS IRONWORK CO<sup>L</sup>D.

IMPROVED PATENT STABLE FITTINGS.



The Stable shown in the accompanying illustration was recently erected and fitted throughout for Sir Weetman D. Pearson, Bart., M.P., at Paddockhurst, Worth, Sussex, by the St. Pancras Ironwork Co., Ltd. Special attention has been given to lighting, ventilation, and drainage, and the comfort and health of the animals to be housed has been considered in every detail. The St. Pancras Ironwork Co., Ltd., are Specialists in Stable, Cow House and Piggery Fittings, Harness Room Fittings, Paving, Drainage, Ventilation.

*Catalogues Sent on Application.*

**171, St. PANCRAS Rd., LONDON, N.W.**

Telephone 519 North.

Telegrams: "Equitation, London."

# EVERYTHING FOR THE FARM

**HORSE & CATTLE FOODS.**

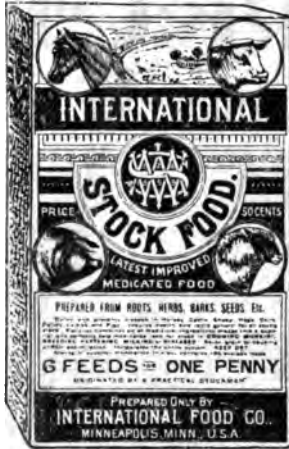

**The Southwell  
SUGAR MEAL.**



**SPLENDID FOR ALL STOCK.  
Rapid Fattener, Milk and Cream  
Producer, and Economical.**

## MACHINERY & IMPLEMENTS.

**SAFETY OIL & PETROL ENGINE.**

High Grade.  
Reliable.  
Economical.



Chaff-Cutting.  
Pulping.  
Pumping.

**PUMP SEPARATOR.**



SILVER MEDAL, R.A.S.E.

**KID KANGAROO PLOUGH.**

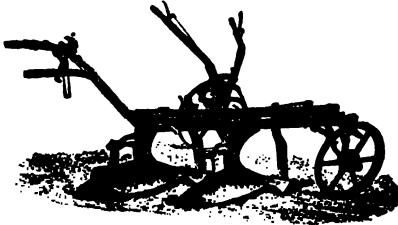

The most popular plough on wheels.

**"TWO MINUTE" CHURN.**

SILVER MEDAL, DAIRY SHOW, 1907.

Send for Illustrated Price List and Particulars to

**F. C. Southwell & Co., Ltd., 75, SOUTHWARK ST  
LONDON, S. E.**

**THE RELIANCE  
LUBRICATING OIL CO.,**

19 & 20, Water Lane, Great Tower Street, London, E.C.

PREPARED SPECIALLY for FARMERS & ENGINE OWNERS.

Heavy Non-gumming Engine Oil, Steam Refined Black Cylinder Oil, Black Varnish, Disinfectant &c., AT LOWEST PRICES.

"Reloc" the Sportsman's friend, for Firearms, Talking Machines, Technical Instruments, &c. Cleanser and Lubricator. Bottle 1s., post free.

**WATER SUPPLY,** Well Sinking, and Boring.

**WIND ENGINES,** Oil and Petrol Engines.

**PUMPS** of all descriptions. Tanks.



**RICKMAN & Co.,**  
Engineers,  
13, Walbrook, E.C.

**HARPER ADAMS  
AGRICULTURAL COLLEGE,**  
NEWPORT, SALOP.

This Endowed Residential College provides complete PRACTICAL and SCIENTIFIC COURSES in AGRICULTURE. Courses of Study qualifying for all the higher Agricultural Examinations. Laboratories, Farm (recently extended), Dairy, Workshops. For full particulars apply to the Principal,

F. HEDWORTH FOULKES, B.Sc., F.R.S.

**R. W. Green**

Has again grown both in Scotland and England every leading variety of

**SEED POTATOES**

Expressly for Seed Purposes, and solicits enquiries.

**CORNHILL, WISBECH**

**THE UNIVERSITY OF LEEDS.**  
DEPARTMENT OF AGRICULTURE.

Complete Courses in Agriculture, suitable for Farmers, Land Owners, Land Agents, Valuers, or Teachers of Agricultural Science.

The Winter Courses prepare for the NATIONAL DIPLOMA.

INCLUSIVE FEES: Complete Winter Course, £10. Special Summer Course, £5.

AMPLE PROVISION FOR RESEARCH. Special Branches of Agriculture dealt with in Summer Session. The FARM WORK and EXPERIMENTS at GARFORTH form an integral part of the instruction.

Students may take Agriculture in the Final Examination for the Degree of B.Sc.

Prospectus from the REGISTRAR, the University of Leeds.

**PROTECTION FOR FARMERS!!!  
DRIFFIELD'S**

**NEW PIONEER SWEDE and PURPLE VICTOR TURNIP,**



Having been officially tested on farms infested with "Finger and Toe" against more than 20 varieties, including so-called *Dianthi-rotting* (?) Turnips, have proved ABSOLUTELY UNRIVALLED in withstanding this Disease.

GENUINE ONLY IN SEALED BAGS, under the Growers' Trade Mark.

Remarkable and convincing Crop Reports on application.

**Thos. N DRIFFIELD & SONS,**  
Brafferton Seed Farms, YORK.

**SHROPSHIRE.**

Shrewsbury, Wellington, Wem, and Oswestry. Messrs. HALL, WATERIDGE & OWEN, Auctioneers, Valuers, Surveyors & Estate Agents. Offices: High St., Shrewsbury; Church St., Wellington; 19, High St., Wem; Bank Chambers, Oswestry.

Sales of Landed Estates, Residential and Business Properties, Stannic Timber, Machinery, Agricultural and Pasture Stock, and Furniture. Agricultural Valuers and Arbitrators. Monthly Horse Sales at the Raven Horse Race-course and Trial Grounds, Shrewsbury.

**Cyclopedia of American Agriculture.**

Edited by L. H. BAILEY. Fully Illustrated. In Four Volumes.

Vol. I.—FARMS: REGION SOILS, FARM PLANTS, ATMOSPHERE.

Vol. II.—CROPS. Imperial 8vo. 21s. net each.

**MAGMILLAN & Co., Ltd., LONDON.**

THE WORLD-FAMED

# "Angelus" PLAYER-PIANOS

BY ROYAL WARRANT TO HM. THE KING OF GREECE.

AS SUPPLIED TO H.M. THE KING OF PORTUGAL.



The **MELODANT**

The Wonderful New Expression Device.

The **PHRASING LEVER**

gives Freedom and Individuality to the Performer.

**AS PURCHASED BY ROYALTY AND THE WORLD'S GREATEST MUSICIANS.**

The Angelus Player-Piano can be played on the Keyboard in the ordinary way, or with the aid of the Angelus Music Roll.

**The Melodant** The glorious possibilities of the Angelus Player-Pianos have been still further increased by the recent invention of this wonderful expression device. The MELODANT accentuates the melody or "air," bringing out the melody notes clearly and distinctly above the accompaniment, whether in bass or treble, or in the midst of a full chord, or where they would otherwise be wholly covered in a maze of musical ornamentation.

**The Phrasing Lever** the marvellous device controlling every variation of tempo, enabling the performer to answer perfectly the technical, intellectual, and emotional demands of the most simple or difficult music, preserving its marked time and true character, but admitting of rhythmic variations which give distinction and impart individuality.

**The ANGELUS-BRINSMEAD Player-Piano** combines all the greatest features of two world-renowned instruments in one case. The result is unrivalled touch, tone, and expression, with the maximum of reliability.

**The ANGELUS PIANO-PLAYER** (in Cabinet Form) will play any Grand or Upright Piano; is adjusted and removed from the Piano in a moment. Beautiful in design and appearance, it contains all the exclusive features which have made the Angelus supreme.

*Kindly call or write for Illustrated Catalogue No. 105.*

**J. Herbert Marshall,**  
Deposited at Angelus Hall, Regent House, 233 REGENT ST LONDON, W.



# WHITE HORSE WHISKY.

## GREYHOUND

**SPECIAL**

**42/- a Dozen.**

The equal of most of the 4/- brands as a comparison will prove.

*Glasgow City Analyst says :*

"A high class whisky of exceptionally fine flavour and quality, well matured in wood."

**48/- a Dozen.**



*Only home-grown barley used at our Distilleries.*

**MACKIE & CO., DISTILLERS, Ltd.,**  
GLASGOW, ISLAY, & LONDON.

## JOHN UNITE, LIMITED, 291 & 293, EDGWARE ROAD, LONDON, W.

By Appointment to H.M. The King and H.R.H. The Prince of Wales.

Canvas, Tent, & Flag Contractors to R.A.S.E.,  
Highland and Yorkshire Agricultural Societies, &c.  
Horse Clothing and everything for the Stable.  
500 Tarps in Stock for  
Machines, Wagons, Engines, &c.

**Stallion Outfits,**  
**Mackintosh Coats,**  
**Capes and Aprons,**

**Tents,**  
**Rick Cloths,**  
**Blinds, Cordage.**

Pavilions, Tents, and Flags for Royal Ceremonies, Public Rejoicings, Balls, Weddings, Bazaars, Flower Shows, Fêtes, and Garden Parties.

**JOHN UNITE, LIMITED, 291 & 293, EDGWARE ROAD, LONDON.**

# FRUIT AND VEGETABLE BOTTLING APPLIANCES.

These Appliances ensure a full store of Delicious Fresh Fruits for Dessert and Cooking, and for Commercial purposes the secret of a profitable trade is obtained.



**FWLER'S** Complete Fruit Bottling Outfits, consisting of Patent Apparatus, Book of Directions, Bottles, &c., &c., 50/-. 35/-. and 20/- each.

**BOTTLED FRUITS**, 7/6 per dozen ; 3 dozen, 21/-.

Post Free, 1 bottle of Fruit, 1/6 ; 3 bottles, 3/6.

Royal Agricultural Society of England, Maidstone, 1899.

**JUDGE'S REPORT.** See R.A.S.E. "Journal," 1899, page 558 -

*"I have personally tested this Apparatus since the Show, and find it most satisfactory in every way. It is particularly simple and easy to manipulate."*

**AWARDED 24 GOLD AND SILVER MEDALS.**

And at the R.H.S. FRUIT SHOWS, LONDON, 1902, 3, 4, 5, 6, & 1907, GOLD and SILVER MEDALS, and other PRIZES were Awarded to Exhibits of Fruit and Vegetables bottled with our Copyright System and Appliances.

Oswald H. Latter, Esq., M.A., Charterhouse, Godalming, Surrey, writes: -

February 24th, 1906.

"Your process of Bottling Fruits, &c., is absolutely sound on scientific principles. I have been advocating some such method for years. You have effected it in a delightfully simple manner."

## GEO. FOWLER, LEE & Co., MAIDSTONE.



# STEP | PETTIFER & SONS,

## "Safe and Sure" VETERINALITIES.

A full line of Animal Remedies and Veterinary Instruments for general use.

### "SANTOYIN" (Regd.).

The World-famed Remedy for Sheep and Lambs. A sure cure and Preventive for Parasitic Diseases, TAPEWORMS, HUSK OR HOOSE AND ROUND WORMS, FEVERS, SCOUR, and Debility in Sheep and Lambs. Exhibitors and Breeders find it an invaluable help in "fitting" their Show and Sale Sheep and Rams. It is also an efficient remedy for Scour in Calves and Weakness and Debility in Cattle.

Used continually on the Royal Farms, by eminent Breeders in all parts of the World, and supplied to Colonial Government Departments of Agriculture, and to U.S. Government Agricultural Experiment Stations.

Sold in Cans, 5/- each (30 to 40 doses); also bulked in half-gallon Cans, 13/6 each (90 to 120 doses); one gallon Cans, 25/- each (180 to 240 doses for Lambs), each with dose bottle in receptacle at top.

### "SANTOFORM" (Regd.).

Unequaled as a general antiseptic powder for wounds, sores, and injuries in all animals As a NAVEL DRESSING for newly-born foals, calves, and lambs, it prevents navel ill, joint evil and infantile scour or diarrhoea. A pure chemical product. Is cheaper than anything else on the market, is non-poisonous and odourless in use, and "a little goes a long way." In sprinkler tins, 1/9 each, £1 per doz. case; and 1/- each, 11/6 per doz. case.

Sample tube free on application.

Stock Marking. No mutilation or branding.



Adopted by Colonial and Government Farms, and in use all over the World.



CLINCHED.

## "Clincher" Stud Ear Marking Tablets

FOR ALL ANIMALS.

The best on the market. Made of pure aluminium, feather weight, do not catch, sag, or disfigure, or pull out of the ear, are easily put on, and look neat and pleasing to the eye.

Price 10/6 per 100, marked with initials, numbers, and date of year on washer (ordinary size for Cattle, Sheep, and Pigs). Larger size for Cattle, 15/- per 100 (put up in convenient, numbered, and partitioned Box). Punches for ear, 3/6 each. Samples and order form free.



### FREE.

Useful Sheep Book, "Health for Sheep."—32 pages, illustrated.

Also Lambing Register Card.

Patents and Factors in Veterinary Instruments for general use.

### Sole Proprietors:

Note name & Only Address  
**Stephen Pettifer & Sons.**  
MALMESBURY, WILTS.  
Established 40 years.

Illustrated and General Lists Free. Telegrams: PETTIFERS, CRUDWELL.

CAUTION.—Beware of IMITATIONS; and in connection with "Pettifer," always remember "STEPHEN."

JOHN

# SAFETY FEEDER CHAFF CUTTERS

GOLD MEDAL,  
PARIS, 1900.

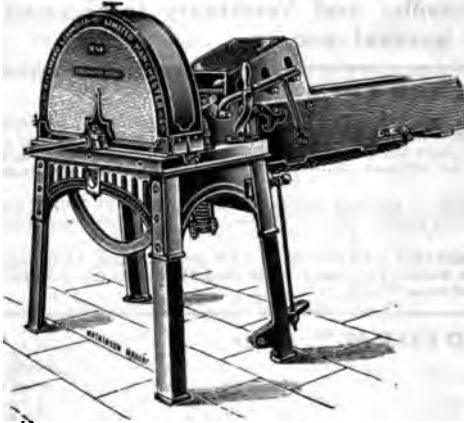

GREAT COMPETITION at the Royal Agricultural Society of England's Birmingham Show, 1898.

Sixteen different Appliances were Tested at the Trials. The Judges awarded the PRIZE of £10 to RICHMOND & CHANDLER, Limited, for their "Mutilux" Patent Safety Feeder.

Since improved, and numerous other Prizes have been awarded.

**OORN CRUSHERS.  
ROOT PULPERS.  
OIL OAKE MILLS.**

**RICHMOND & CHANDLER, Ltd., MANCHESTER.**

Awarded Silver Medals Altrincham Agricultural Show, Sept. 24, 1896, and Crewe Agricultural Show, August, 1897. STAND 80 ROYAL AGRICULTURAL SHOW, LINCOLN, 1907.

## T. NEWTON'S Patent SPARROW & RAT TRAP.

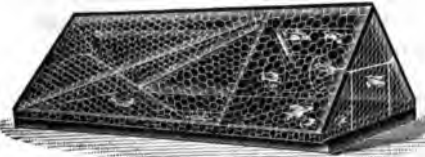

This Trap is available for catching Sparrows, Rats, Weasels, and Stoats. 80 Sparrows have been caught in one hour, and 27 Rats in two hours. Over 4,000 Sparrows caught in one of Newton's Traps in one season. See *Field*, Feb. 4, 1907.

Price 10/6 each. Cash with order. If made Rat-proof (lined with zinc) for Rats and Sparrows, 13/- each. Sudden Death Wild Animal Traps, 10/6 each. Humane Automatic Run Traps for catching alive Wild Cats, Rabbits, Stoats, and Weasels. Just invented for the suppression of steel traps. Price 5/- each for Rabbits, &c.; 10/- for large animals. Cash with order.

**T. NEWTON, Gun Maker, 48, King St. West, MANCHESTER.**

To Exhibitors and Others.

**MORRIS, "THE WRITER,"  
SIGN EXPERT.**

Studio and Works:

**CASTLE SQUARE,  
NEWCASTLE-ON-TYNE.**

NATIONAL TELEPHONES, 184 and 4770.

Royal Agricultural Society Show, 1908.

**EMPRESS . . . . .**  
*Nat. T.L.L.*  
 1715 Central  
**APARTMENT AGENCY,**  
 144, Northumberland Street,  
 Newcastle-upon-Tyne.

Mrs. LYON desires to intimate to the Exhibitors and Members of the above Society that she has a number of Private Furnished Houses and Apartments on her list available before and during the Show. Enquiries Solicited.

Comparative public field test of Leighton's RED CLOVER, with other selections, *vide* Harper Adams' Agricultural College Reports, 1908.



Photographs by College Authorities.

## ONE QUALITY ONE PRICE.

Percentage of Growth and Purity stated and Guaranteed.

Arrangements have been made whereby . .

### FREE ANALYSIS

for orders for Grasses and Clovers supplied Spring 1908, amounting to £10 and upwards, will be given by Messrs. Carruthers & Gussow, 44, Central Hill, Norwood, London, and The Harper Adams Agricultural College, Newport, Shropshire.

**SPECIAL SELECTIONS of  
GRASSES and CLOVERS**



FOR VARIOUS  
SOILS AND .  
CONDITIONS. .

ALL SEEDS SENT SEPARATELY.

CATALOGUES POST FREE.

**LEIGHTONS' SEED WAREHOUSE,**  
Newcastle, Staffs.

Telegrams : "Cheval," Newcastle.

ESTABLISHED OVER 50 YEARS.

Nat. Telephone, 3145.

# T. HOWE & Co.,

JOBMASTERS,

**The Mews, Higham Place, Newcastle-on-Tyne,**

Orders for—

LANDAUS,  
BROUGHAMS,  
VICTORIAS,  
PRIVATE BUSES,  
Etc.,

Receive Prompt and Careful  
Attention.

*Cordially invite enquiries and  
inspection of their High-Class  
Stud of Carriage Horses, to  
let on the Job by the Day,  
Month, or Year.*

Contractors to—  
The Right Hon.  
the Lord Mayor  
of Newcastle.

**HEAD OFFICES : 11, PERCY STREET.**

Nat. Telephone, 1490.

Largest and Oldest Live Stock and Export Agency in Great Britain.

**PRACTICAL FARMERS IN 57 COUNTIES**

(Whose Testimonials will be sent on application)

**TESTIFY THEIR COMPLETE SATISFACTION**

With the Live Stock with which they have been supplied by

**E. Goodwin Preece,** Live Stock Agent,  
**SHREWSBURY,**

Who attends the leading Fairs and Sales to buy on Commission  
**Cattle & Sheep for Feeding, Dairy, or Breeding.**

*Satisfaction Guaranteed. Personal Buying.*

Orders invited at once for Cattle and Sheep, as at present rates a Good Profit is assured.







**Breeders supplied with PEDIGREE STOCK of all kinds,**  
Selected from the leading Studs, Herds and Flocks.

**DAIRY COWS,** specially selected deep milkers. **STALL FEEDERS, Bullocks and Heifers** of prime quality. **YOUNG STOCK & OUTLYING CATTLE** for wintering. **WETHERS** for folding and grazing. **EWES-IN-LAMB.** **STOCK BULLS** of reliable dairy or beef breeding. **PEDIGREE STOCK** of all breeds from reliable herds. **SHIRE STALLIONS** or Mares of the best and weightiest type.

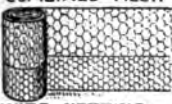
Write for Prices. Every assistance to Buyers. Large numbers of Cattle and Sheep always on hand.

Letters and Telegrams:—

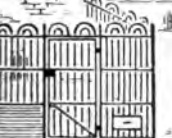
**Preece, Crosshill, SHREWSBURY.**

<p>COMBINED · MESH</p>  <p>WIRE · NETTING.</p>	<p>CONTINUOUS · BAR · FENCING</p> 	<p>W. I. UNCLIMBABLE</p>  <p>RAILING.</p>
<p>GARDEN ARCHES Etc.</p>  <p>TREE · GUARDS.</p>	<p><b>BAYLISS, JONES AND BAYLISS, LTD. FENCING, GATES &amp; C.</b></p>	<p>CORRUGATED SHEETS.</p>  <p>SHEEP · HURDLES · ETC.</p>
<p>DOG KENNEL &amp; POULTRY RAILING</p> 		<p>ORNAMENTAL · WROUGHT · IRON · GATES.</p> 
<p>VICTORIA WORKS · WOLVERHAMPTON &amp; CANNON ST LONDON · E.C.</p>		

## FERTILISERS and FEEDING MATERIALS.

**ARTIFICIAL FERTILISERS.**—H. R. & Co. will be glad to forward to intending purchasers their Catalogue of **Artificial Fertilisers**—of various kinds—and **Feeding Materials**, with price lists, etc., on application.

**Contents.**—Superphosphates, various qualities; and Pure Vitriolized Bones; Bones and Bone Meals, raw and steamed; Undissolved Phosphates; Basic Slag and Thomas Phosphate Powder; Guano—Peruvian, various qualities, some rich in ammonia, others in phosphates; Damaraland; Rape Dust and Rape Meals; Fish Manures; Sulphate of Ammonia; Nitrate of Soda; Potash Salts—Kainit, Muriate, Sulphate, etc.; Specially prepared manures for Grass, Corn, Potatoes, Turnips, Mangolds, also for Topdressing, etc., with guaranteed analyses; also manures specially prepared for Gardens, Fruit Trees, Lawns, Tennis Courts, Cricket Pitches, etc.

**BASIC SLAG.**—For Autumn and Winter application, specially recommended for Poor Grass Land, Autumn Wheat, Seeds, Beans, Peas, Turnips, etc. Highest qualities supplied on favourable terms. Quotations on application.

**LINSEED CAKES.**—Finest quality, own brand. Guaranteed to be made *entirely* from well-screened seed of 95 per cent. purity, with *pro rata* allowance if below 12 per cent. oil, 20 per cent. albuminoids, or exceeding 1 per cent. sand. Also foreign Linseed Cakes of selected brands—Russian, American, etc. **COTTON CAKE**, own brand [H. R. Co., PURE], entirely from finest new Egyptian seed, with guaranteed analysis; also other approved brands. Decorticated Cotton Cakes and Meals, Rice Meal, Maize, Locust Beans, and Meal.

**ECONOMY IN CARRIAGE.**—H. R. & Co. make a specialty of forwarding articles of English make—both Feeds and Fertilisers to their clients' stations, *direct* from the nearest point of manufacture; and goods of foreign import direct from the nearest port of arrival, thus minimising carriage.

### HY. RICHARDSON & COMPY.,

Agricultural Merchants and Manufacturers of Chemical Fertilisers,  
SKELDERGATE BRIDGE, YORK.

Telephone No. 39.  
Telegraphic Address:  
"ROPE, WALSALL."

ESTABLISHED 1837.

WORKS:  
TANTARRA STREET and  
SELBORNE STREET

**J. HAWLEY & Co., Goodall Street, Walsall,**

MANUFACTURERS OF

ROPES, TWINES,  
CORDS, &c.

Cart, Waggon, and  
Rick Sheets.

Price Lists on Application.

**JOHN HAWLEY & Co.,**  
Goodall Street, Walsall.



ROYAL AGRICULTURAL SOCIETY OF ENGLAND.

### FARM ACCOUNT BOOKS.

No. 1.—A DIARY, combining the CASH ACCOUNT with a daily record of all FARM TRANSACTIONS. (Price 4s.)

No. 2.—A FARM ACCOUNT BOOK, showing PAYMENTS AND RECEIPTS, and supplying a form of ANNUAL BALANCE SHEET. (Price 5s. 6d.)

Obtainable through any Bookseller, or direct from the Publishers—

**FORSTER, GROOM & Co., Ltd.,** 15, CHARING CROSS,  
LONDON, S.W.

# J. H. Peck & Co.

Limited,

AWARDED  
70 GOLD AND  
SILVER MEDALS.

## Wigan,

ESTABLISHED  
1808.

MANUFACTURERS OF . . .

**CART, WAGON, and STACK**  
**COVERS, BINDER TWINE, ETC.**



**Established One Hundred Years.**

**BEFORE PLACING YOUR ORDERS IT WILL PAY YOU TO SEND FOR OUR SAMPLES AND PRICES.**

**GOODS FOR HIRE:**



- |                    |                         |
|--------------------|-------------------------|
| Portable Ballrooms | Dog Benches             |
| Bazaar Decorations | Poultry Pens            |
| Marquees           | Pigeon Pens             |
| Tents              | Tables                  |
| Shedding Canvas    | Turnstiles and Barriers |
| Chairs             | Tarpaulins              |
| Lamps              | Wagon Sheets            |
|                    | &c., &c.                |

**ESTIMATES FREE for the Fitting-up complete of Agricultural Shows, Dog and Poultry Shows, Flower Shows, Fetes, &c., &c., including Benching, Penning, Feeding, &c., &c. Write for full particulars to—**

**J. H. PECK & Co. LTD., WIGAN.**

Telegraphic Address:—PECK, WIGAN.

Telephone No.:—71, WIGAN.

## BREEDERS' DIRECTORY.

**HORSES.****Clydesdales.**

**SEAHAM HARBOUR STUD CO., THE.** Breeders and sellers of Clydesdale Horses of the improved type, combining size with quality and fashionable pedigree. Inspection invited. Apply, R. Brydon, Seaham Harbour, County Durham. Wires: Brydon, Seaham Harbour.

**Hackneys, Roadsters, Hunters, &c.**

**CONCHAR, JOHN, WYLDE-GREEN, BIRMINGHAM.** Breeder of high-class Hackneys. Several have been successful in the show-ring. Colts and Fillies by the leading stallions of the day.

**LONGE PADDOCKS HUNTER STUD, HOCKLEY HEATH, WARWICKSHIRE.** High-class Made and Un-made Hunters, prize-winning Brood Mares, and youngsters always on view and sale. Apply, Studgroom. Telegrams: Bowen, Hockley Heath. Station: Knowle, G.W.R.

**MCALLISTER, WM., THE INVERNESS HACKNEY STUD, INVERNESS.** Breeder and exhibitor of Pedigree Hackneys of the most Fashionable Yorkshire blood. Winners at Hackney Shows, London; R.A.S.E.; Royal Lancashire; Wirral and Birkenhead; Kilmarnock; Ayr; Edinburgh; Glasgow; Royal Northern Aberdeen; and the Highland Society Shows. Young stock for sale, all winners, by Champions Rosador, Administrator, Garton, Duke of Connaught, and St. John. Telegrams: Hackney, Inverness.

**MANCHA, R. A. DE, WATERSIDE STUD, FROGMORE, ST. ALBANS, HERTS.** Breeder of high-class Hackneys. Stallions, Mares, and young stock by Danegelt, Rosador, Garton Duke of Connaught, His Majesty, &c. Stations: Bricket-wood (L. & N.W.), Radlett (Midland). Telegrams: Parkstreet, Herts.

**MOORE, HENRY, BURN BUTTS, CRANSWICK, HULL.** Pedigree Stud of Hackneys, including many prize winners. Yearlings, two, and three-year-olds, and others can be seen on application to Henry Moore.

**PARMLEY, JONATHAN KIPLING, BARDSEA, ULVERSTON, LANCASHIRE.** Farmer and Breeder of Hackneys and Carriage Horses, has mostly of young horses on hand of different ages. Sires used are R. and P. Hartley's, Esquires, Blackburn.

**SHORTER, SYDNEY, OAKLANDS STUD FARM, SHIPLEY, SUSSEX.** Breeder of Hackneys. Stud Horse: King's Equerry 8915, by Royal Danegelt 5785, dam 3034 Marion, by Wildfire 1224. Station: Southwater (L.B. & S.C.R.). Telegrams: Shorter, Oaklands, Coolham, Sussex.

**HORSES—continued.****Shires.**

**BELL, CHARLES, NORLEY HALL, NORLEY, CHESHIRE.** Shires of most fashionable blood. Stallions for sale, hire, and service at home. Mares and Fillies for sale. Telegrams: "Norley." Railway stations: Acton Bridge and Delamere.

**BLAISDON STUD, COLIN MACIVER.** Owner. Stallions for hire or service. Young stock for sale. J. S. Bate, Agent, Blaisdon, Glos.

**CONCHAR, JOHN, WYLDE GREEN, BIRMINGHAM.** Breeder of Shires and Hackneys. Several have been successful in the Show-ring. Colts and Fillies by the leading stallions of the day.

**JACKSON, J. C.** Breeder of Shires (Stud established 1898). Stallions: Knottingley Regent 18130, Kirk Hammerton, King Maker 24359. Fillies and Colts for sale. Apply, Faulkner, Smallagee, Skyehouse, Snaith, R.S.O., Yorks. Station: Askern.

**JACKSON, R. NEWTON, BLACKBROOKE, PONTRILAS, HEREFORD.** Stud Horses: Lockinge Lord of Mirule and Lockinge Bonny Lad, both by Lockinge Forester, full brother to Lockinge Forest King. Colts and Fillies for Sale.

**MUNTZ, FREDERICK ERNEST, UMBERSLADE, HOCKLEY HEATH, WARWICKSHIRE.** Shire Horse Stud Stallions, Mares, Fillies; prize winners. Particulars from Mr. John T. B. Hartley, Estate Office, Umberslade, Hockley Heath, Warwickshire.

**PEARSON, E. E., BRICKENDONBURY, HERTFORD.** Stud Horses, Normoor Jameson 23556, Cambrian Squire 21246, Cole-shill Forester 24149. Mares and Fillies, including prize winners, for sale; inspection invited. Stations: Hertford, Great Eastern and Great Northern. Apply, Estate Office, Brickendonbury, Hertford. See Advertisement page 43.

**Various.**

**DICKINSON, J. & G., CARK MILLS, CARK-IN-CARTMEL.** Breeders and Exporters of Hunters, Hackneys, Shires, all ages; thoroughly trained and unbroken. Best Yorkshire, Westmorland, Cumberland, and Lancashire blood. Nearly all prize-winning stock. 200 prizes won three years, including London, Royal North Lancashire, Championships North Lonsdale, Cartmel, Southport, and Ormskirk. Communications invited. Station: Cark-in-Cartmel (Furness Railway).



BREEDERS' DIRECTORY.

**HORSES—continued.**

**Polo, Riding, and Harness Ponies.**  
**MILLER, W.S., FOREST LODGE, BRECON, S. WALES.** Extensive breeder and exporter of best class of Welsh Mountain Ponies, Cobs, and Entires.  
**PHILIPPI, E. ALEXANDER, CRAWLEY COURT, NEAR WINCHESTER.** Breeder of Thoroughbred Polo Ponies. Station: Winchester, five miles distant. Telegrams: Crawley. Hants.

**CATTLE.**

**Aberdeen Angus.**

**HURSLEY PARK HERD OF ABERDEEN ANGUS CATTLE,** the property of Sir George Cooper, Bart., comprising Erica Pride, Miss Burgess, Lady Ida, Matilda, Jemima of Morlich families. Prizes won during 1906: 7 firsts, 3 seconds, 3 reserves, 1 challenge cup, 2 silver medals, 3 reserve champions. Bulls, cows, and Heifers for sale. Catalogues on application to J. E. Thorold, Estate Office, Hursley Park, Winchester.

**MCAINSH, JOHN, CONGASH, GRANTOWN-ON-SPEY, N.B.** Pure-bred Aberdeen Angus Cattle. Particulars on application.

**ROCKLIFFE PARK HERD OF ABERDEEN ANGUS CATTLE.** Ericas and Prides. Stock Bulls: Pundit of Preston 17156, Champion Highland Show, 1904, and Eliphaz 23103. R. C. Swan, Rockcliffe Park, Darlington.

**Ayrshires.**

**FERGUSSON-BUCHANAN, LIEUT.-COL., AUCHENTORLIE, BOWLING, SCOTLAND.** Ayrshire Cattle, Winner of prizes at all the principal shows in Scotland, also of the Royal Agricultural Milk-Yield Test. Bulls and Heifers for sale. Inspection invited.  
**WALLACE, JAMES, J.P., AUCHENBALZIE, THORNHILL, N.B.** Breeder of Pedigree prize-winning Ayrshire Cattle. This herd of old standing is bred for dairy purposes: beauty and style with good milking properties. Heifers and Bulls for sale.

**Dutch.**

**DUTCH, THE BEST RENT-PAYING DAIRY CATTLE IN THE WORLD.** Over 200 head kept. Record from one cow, 1615 imperial gallons of milk in twelve months. Bulls always on sale. Apply, John Brown, Marden, Hertford.

**Herefords.**

**HILL, JOHN RICHARD, ORLETON COURT, R.S.O., HEREFORDSHIRE.** Pedigree Hereford Cattle. One of the oldest herds extant. Young Bulls and Heifers of purest lineage and excellent quality for sale.

**JACKSON, R. NEWTON, BLACKBROOKE, PONTRILAS, HEREFORDSHIRE.** Pure-bred Hereford Cattle, with pedigrees

**CATTLE—continued.**

dating back to very early volumes of Herd Book. Bulls and Heifers for sale at reasonable prices. Shire Horses and Shropshire Sheep.

**SALTMARSH CASTLE ESTATES, HEREFORDSHIRE.** Prize-winning Pedigree Hereford Cattle. Inspection invited. Good selection for sale. Won Grand Prix at International Exhibition, Paris. Apply, J. W. Millyard, Estate Office, Littlebridge, Bromyard.

**Jerseys and Guernseys.**

**CARY-ELWES, V. ESQ., BILLING HALL, NORTHAMPTON.** Railway Station: "Billing," L. and N.W.R. Breeder of Pedigree Jersey Cattle.

**FOWLER, DE LA PERBELLE & Co., SOUTHAMPTON.** The largest Importers and Exporters of Pedigree Jerseys and Guernseys. Always a large selected herd maintained at their depôt, Porter's Lane, near Royal Pier, Southampton. Winners of the highest honours at the leading shows. Cows and Heifers down calving all the year round. Shipping attended to under personal supervision with experienced men. Freight, insurance, &c., arranged most advantageously. Original Exporters to the States, South America, and the Colonies. Horn Trainers and Self-Piercing Bull Rings. Cables and Telegrams: "Importers, Southampton."

**TICHBORNE PARK GUERNSEYS.** Young Bulls and Heifers from the most select strains for sale. Apply D. Michie, Estate Office, Tichborne, Alresford, Hants.

**Kerries and Dexters.**

**CORY, SIR CLIFFORD J. BART. M.P., LLANTARNAM ABBEY, MONMOUTHSHIRE.** One of the largest herds in the Country. Championship winners at the Royal and other principal shows. Particulars of animals for sale on application.

**RATTRAY, DAVID M., GORTNASKEHY, BALLYBUNION, CO. KERRY.** Pedigree prize-winning herd of Kerries and Dexters. 156 prizes and honours won by Cattle from this herd past three years. Bulls, Cows, and Heifers for sale.

**Lincolnshire Red Short-horns.**

**ROBINSON & SON, ANDERBY, ALFORD, Lincs.** Lincoln Red Short-horn Bulls for sale, descended from the best herds. Beef and Milking qualities combined. Inspection invited. Station: Mumby Road, G.N. Railway.

**Polled Angus.**

**HOYLES, GEORGE, SKIDBY MANOR, HULL.** Polled Angus Cattle, Queen Mother, Erica, and Prides. Bulls and Heifers for sale. Inspection invited. Several prize winners.

## BREEDERS' DIRECTORY.

## CATTLE—continued.

## Red Polled.

**BROWN, THOMAS, & SON, MARHAM HALL, DOWNHAM MARKET.** Herd established 51 years, P3 strain predominates. Many prizes won, including R.A.S.E. Championship. Sires used include Norfolk Duke 127, Royal Duke 181, Erebus 841, Uncas 3704, all R.A.S.E. Champions; stud Bull Davyson 241th 9059, triple champion R.A.S.E.; milking qualifies a speciality. Animals always on sale. Telegrams: Brown, Hall, Marham.

**CRANWORTH, THE RIGHT HON. LORD,** offers grand young dual-purpose Red Polled bulls, cows, heifers from champion prize stock; milk reaching 12,230 pounds in a year. Apply C. F. Stebbing, Letton, Thetford, England.

## Shorthorns.

**BARROW, B. LANGDALE, SYDNOPE HALL, NEAR MATLOCK.** Pure-bred Shorthorns, prize-winners, tracing through Herd Book, Vol. I. Young Bulls often for sale. Inspection by appointment any afternoon. Nearest Station, Darley Dale (Midland Railway).

**BELL, CHARLES, NORLEY HALL, NORLEY, CHESHIRE.** Shorthorn Bulls for sale from Kirklevington, Red Rose, Barrington, and Cruikshank tribes. Telegrams: "Norley." Railway stations: Acton Bridge and Delamere.

**GRANT, G. R., AUCHNACREE, FERN, BRICHIN, N.B.** Select Shorthorns, Cruikshank Butterflies, and other well-known families.

**HUNTER, T., STONE ROW HEAD FARM, LANCASTER.** Pedigree Dairy Shorthorns. Strains kept: Telluria's, Fog-gathorpe's, Barrington's, Gwynne's, &c. Forty-one prizes won 1907, including 2nd Milking Trials, Royal Show, Lincoln; Shorthorn Society's Special, Westmorland.

**LEON, H. S., BLETCHLEY PARK, BUCKS.** Herd of Pedigree Scotch Shorthorns; young Bulls and Heifers always on sale, from the oldest and finest blood. Winner of first prizes at Park Royal, Highland, Royal Dublin, Smithfield, Birmingham, and London Dairy Shows. Exporters and breeders are invited to pay the farm a visit. Address: J. T. Watson, Home Farm, Bletchley, Bucks.

**LEWIS, HERBERT C., HEAN CASTLE, SAUNDERSFOOT, PEMBROKESHIRE.** Pedigree Shorthorns of best Bates and Cruikshank strains; heavy-fleshed Young Cows, Heifers, and Bulls; Reds and Roans, fit for export; by Royal Prize Bull, "Bapton Sceptre" 82773.

## CATTLE—continued.

**MACKAY, H. M. S., BURGIE LODGE FARM, FORRES, N.B.** Select Herd of Shorthorn Cattle, winners of prizes at Highland and Agricultural Society's and other shows. Station: Kinloss (Highland Railway).

**MOSLEY, SIE OSWALD, BART.** High-class Shorthorns at the Home Farm, Rolleston Hall. A few Bulls and Heifers on sale. Apply to A. E. Beck, Estate Office, Rolleston Hall, Burton-on-Trent.

**RIDDELL, JOHN, TIMBERLEY, CASTLE BROMWICH.** Breeder of high-class Shorthorns, Bates and Scotch. Rich Roan and Red Bulls and Heifers on sale. Stock Bulls: Elvetham Renown 91623 and Regal Knight 96712.

**STRATTON, RICHARD, THE DUFFRYN, NEWPORT, MON.** Old-established herd combining milk with flesh. Bulls of good colour for sale.

**SWINBURNE, SIR JOHN, BART., CAPHEATON, NEWCASTLE-ON-TYNE,** owns one of the largest and best Bates Shorthorn herds in existence. Bulls and Heifers, choicest strains. For particulars apply Mr. James Hepple, Capheaton, Newcastle-on-Tyne.

**TREDEGAR, VISCOUNT.** Shorthorn Herd. Bulls and Heifers for sale; best strains. Stock Bulls: Clara Lovat's Heir 94663, and Diamond Marksman. Apply, J. H. Hillier, Home Farm, Tredegar Park, Newport, Mon.

**WILLIAMS, HENRY, MOOR PARK, NEAR HARROGATE.** Breeder of pure-bred Shorthorn Cattle. Winner of Royal firsts, champion, and other prizes. Bulls for sale.

**WORDSWORTH, R. DUFFCARRIG, GOREY, CO. WEXFORD, IRELAND.** Pedigree Dairy Shorthorns (Cruikshank and Scotch strains). Successful in dairy and showyard. Young Bulls and in-calf Heifers of good colours for sale. Exportation orders faithfully executed.

## Sussex.

**LORD, JAMES W., NORTHAM, SUSSEX.** Pure Sussex herd; established 1844. Young Bulls for sale. Steyning, Raby, Goldlust 11th, Gondolier, Geoffrey, Gladsome Prince, and Prince Confidence 2nd, strains blood used. Purchasers invited.

## Cattle, Various.

**THE BEST RENT-PAYING DAIRY CATTLE IN THE WORLD.** JOHN BROWN, MARDEN FARM, HERTFORD. Young Bulls for sale. "Royal Duke," in service, bred at Hawkrigg, Wigton. Grand Stock-getter, combining quality with substance. Over 200 head kept. Inspection invited. Telegrams: "Tewin."

BREEDERS' DIRECTORY.

**CATTLE—continued.**

**DARBY, ALFRED, ADCOTE, LITTLE-NESS, SALOP.** Small, select herd, chiefly Booth and Scotch blood. Young Bulls and Heifers of good colours, suitable for export. Can be viewed by appointment. Station: Baaschurch, 2½ miles.

**DEBENHAM, F. G., CHESHUNT PARK, HERTS.** Two miles from Cheshunt Station, G.E.R. Young Bulls and Heifers for sale from choicest pedigree strains.

**HUGHES, GEORGE PRINGLE, MIDDLETON HALL, WOOLEY,** has select herd carefully registered from entry in Vol. III., and leading Bulls at the Royal and County Shows are the progenitors. Yearlings are now for sale.

**SHEEP.**

**Border-Leicesters.**

**HUME, DAVID, BARRELWELL, BRECHIN, FORFARSHIRE.** Winner of Championship of Highland Society for Border-Leicester Sheep on seven occasions, besides many other Championships. Rams sold annually at Kelso, Edinburgh, and Perth.

**Cotswolds.**

**SWANWICK, RUSSELL, ROYAL AGRICULTURAL COLLEGE FARM, CIRENCESTER.** Breeder of Recorded Cotswold Sheep. Exports in 1907 were very successful at Canadian, International, and other Shows. This flock has won 2,658/ in prizes.

**Dorset Horn.**

**ATTRILL, JAMES, WAYTES COURT, BRIGHSTONE, ISLE OF WIGHT.** Registered flock of Dorset Horns. Carefully bred to the best characteristics of this famous breed. Twelve exhibits were made from this flock in England, 1906, winning one champion (Derby, R.A.S.E.), one champion, one cup, eight firsts, one second (to own first), and a reserve. And in North America, 1907, the following honours were taken: two champions, a silver medal, six firsts, and one second. Inspection invited.

**Hampshire Downs.**

**GOLDSMITH, JAMES, BLENDWORTH, HORNDEN, HANTS.** Registered flock of 700 ewes bred on the same farm for fifty years. Annual sale of ram lambs at Alresford Fair last Thursday in July.

**JUDD, SIR GEORGE, COCUM, BARTON STACEY, HANTS.** Pure-bred flock Hampshire Downs. Over 1,000 Ewes, reared in the high and dry, therefore healthy, district of Hants. Selections well suited for exportation. Annual sale Ram Lambs first Thursday August at Cocum.

**SHEEP—continued.**

**PHILIPPI, E. ALEXANDER, CRAWLEY COURT, NEAR WINCHESTER.** Registered flock Hampshire Downs. Prize winners at Winchester and District Show. Rams and stock for sale. Station: Winchester, five miles distant. Telegrams: Crawley, Hants.

**Kent or Romney Marsh.**

**FINN, ARTHUR, WESTBROKE, LYDD, KENT.** Flock established 1770. Inspection invited of 2,000 registered Ewes and Rams, grazed only on Romney Marsh. Highest references to purchasers in South America, New Zealand, and at home. Selections always for sale.

**HAMBROOK, EDWIN, NEWINGTON, FOLKESTONE (Shorncliffe Station, S.E. and C.R.),** registered Kent Sheep Breeder. Hardy, kindly upland flock, pedigree of both sexes on record.

**Lincoln Long Wool.**

**HOYLES, GEORGE, SKIDBY MANOR, NEAR HULL.** Pure Lincoln Long-Wool Sheep. True type, sound constitutions, lustrous long wool, give satisfaction at home and abroad. Rams and Ewes exported to Buenos Ayres, Mexico, and Russia.

**Oxford Downs.**

**THE ROYAL PRIZE FARM FLOCK.** Pure Oxford Down Sheep, Shearing Rams, Ram Lambs, Ewes, and Ewe Lambs for sale. Special arrangements with foreign buyers. Many prizes at R.A.S.E. and other Shows during past 40 years, including 2 firsts, 2 seconds, and 4 other prizes. World's Fair, Chicago: and 11 firsts, 8 seconds, and 2 champions at Royal Bath and West, and Royal Counties, &c., this year. Apply, George Adams, Wadley, Faringdon, Berks.

**Ryelands.**

**SALTMARSH CASTLE ESTATES, HEREFORDSHIRE.** Pure-bred Ryeland Sheep. Splendid quality mutton and wool. Excellent for crossing to produce fat lambs. Apply, J. W. Millyard, Estate Office, Littlebridge, Bromyard.

**Shropshires.**

**BUTTAR, THOS. A., CORSTON, COUPANGUS, SCOTLAND.** Shropshire Sheep of choicest breeding and merit always on sale for export. 260 Breeding Ewes kept. Annual Home Sale in August, Also Shorthorn Cattle.

**Southdowns.**

**HEASMAN, ALFRED, COURT WICK, LITTLEHAMPTON.** Southdown flock, established about 1830, has been publicly exhibited over 40 years, and awarded many prizes at all the leading Agricultural Shows, and is registered No. 30 in the Southdown Flock Book.

## BREEDERS' DIRECTORY.

## PIGS.

## Berkshires.

- AVINS, CHARLES T., AUDMORE HOUSE, GNOSALL, STAFFORD. Pedigree Berkshire Pigs. Boars and Gilts for sale. All eligible for Herd Book. Good quality. Moderate prices.
- BARNES, WILLIAM AUGUSTUS, HASLUCK'S GREEN FARM, SHIRLEY, BIRMINGHAM. Breeder and Exhibitor of Royal and other winners. Boars and Sows of all ages for sale. Inspection invited. Purchasers met by appointment.
- CORY, SIR CLIFFORD J., BART., M.P., LLANTARNAM ABBEY, MONMOUTHSHIRE. Pedigree Berkshires. Particulars of Gilts, &c., for sale on application.
- READING CORPORATION. Herd of 250 Pedigree Berkshire Pigs of the best and most noted prize-winning strains. Correct ages and pedigrees. Now in service: Highmoor Desmond, 11035 (sire, Champion Highmoor Mikado, 10433, dam, Compton Princess, 8402); also the prize winners, Kingstone Domino, 11323 (s. sire, Highclere Topper, 6177), and Dunley Lad, 10860. Inspection invited by appointment with Mr. T. Chettle, The Manor Farm, Reading, Berks.
- SWANWICK, RUSSELL, ROYAL AGRICULTURAL COLLEGE FARM, CIRENCESTER. Breeder of Recorded Berkshire Pigs. Founder of the noted Sallie and Stumpy strains.

## Large Blacks.

- BANNISTER, T., LIMEHURST, HAYWARDS HEATH, SUSSEX (one hour from London; mile from station). Pedigree Large Black Pigs of the best strains of blood. Young Boars and unrelated Sows for Sale.
- OLIVER, R.S., TRECOWE, PAR STATION, CORNWALL. Pedigree Large Black Pigs. Herd established sixty years. Noted prize winners. Hardy and prolific: size with quality. Boars and Sows at moderate prices. Inquiry invited.
- ROBINSON, J. & H., IFORD, LEWES, SUSSEX, breeders of one of the oldest and largest registered herds of Large Black Pigs; very prolific strains, of strong constitution, and good grazers; stock boar Trescowe Pride, winner championship Royal Cornwall, sire of very many winners, including 1st Bath and West, 1907, two firsts and championship, Royal Show, 1907; testimonials from all parts of British Isles and the Colonies. Young Boars and Gilts always for sale: inspection invited. 50 miles from London, express trains.

## PIGS—continued.

## Tamworths.

- DE HAMEL, EGBERT, MIDDLE HALL, TAMWORTH. Pedigree Tamworth Pigs, Boars, Gilts, & In-pig Sows, bred from prize winners at Royal and County Shows. Pr. moderate. Full particulars on application.
- LYDNEY PARK HERD of Pedigree Tamworth Pigs. Young Boars and G for sale; best strains from prize winners. Moderate prices. J. Lau Estate Office, Lydney Park, Glos.
- MOSLEY, SIR OSWALD, ROLLEST HALL, BURTON-ON-TRENT. Pedigree prize-winning strains kept and bred in a healthy natural state in the open Young Boars and Gilts for sale. Apply A. E. Beck, Estate Office, Rolleston Hall, Burton-on-Trent.
- OSMASTON MANOR HERD OF TAMWORTH (PEDIGREE RED) PIGS. Young Boars and Gilts from 1st herd for sale; out of prize winners. Apply, Estate Office, Osma Manor, Derby.
- TAYLOR, C. HOWARD, HAMPTON PRIORY, DONCASTER. Pedigree Tamworths. All bred from prize-winning blood. Good Boars, Sows, and G always for sale at moderate prices. Inspection invited. Telegrams: Hampton Station.

## Yorkshires.

- AYRE, RICHARD, BUSHEY LODGE FARM, WATFORD, HERTS. (15 m from London). Large White Yorkshire Pedigree Pigs of the choicest breeding. Prices moderate. Inspection welcomed. Correspondence invited. Over hundred to choose from.
- AQUILLA DEWHIRST, RYECROFT, DLEY HILL, BRADFORD. Ryecroft herd Pedigree Pigs. Won in 1907 firsts, 11 seconds, 15 thirds, champion plate three times, with home-bred Pigs, not bought. Boars and G for sale at farmers' prices, not at prices. 260 to select from.
- HOSKING, EDWIN, ROSEVIDNEY, LUDVAN, CORNWALL. Breeder of Pedigree Large White Pigs, good type, wide size and quality, from prize Sows; Boars bred from Royal winners; for sale at moderate prices.
- HUGHES, ALFRED, PACKWOOD GRANGE, KNOWLE, NEAR BIRMINGHAM. Select herd of Pedigree Large White Yorkshires, bred from prize winners. Pigs of various ages for sale at moderate prices.

BREEDERS' DIRECTORY.

POULTRY.

Dorkings.

MAJOR. ARTHUR C., DITTON, LANGLEY, BUCKS. Breeder and Exhibitor of Dark Silver-Grey and Cuckoo Dorkings 30 years. Winner £30 Poultry Club Trophy, also three £30 Champion Cups at CRYSTAL PALACE, Birmingham Dairy, Liverpool, and over 1,000 other cups, trophies, and prizes. Birds supplied to His Majesty King Edward VII., and exported to all parts of the world. Prices moderate. Eggs 1s. each.

Orpingtons.

PAGE, LEWIS, BOBBING COURT, SITTINGBOURNE. Orpingtons, Black, Buff, White. Pure-bred splendid laying strains. Over 40 prizes and cards won this year. Birds for sale. Eggs in season. Inspection invited.

Turkeys, &c.

HENSMAN PERCY, FULLETTY GRANGE, HORNCastle, LINCOLNSHIRE. White Turkeys look lovely in parks or yards. Tremendous pedigree and prize-bred Stags and grand unrelated Hens for stock, exhibition, or export. Moderate prices. Approval.

Various.

CREBER, H. C., LANJOSE, ST. GERMAN'S, CORNWALL. Breeder of High-class White Leghorns, White Orpingtons, White Wyandottes. Specially selected laying strains. Unlimited range on Colony system. Price list free. Unsolicited testimonials.

REYNOLDS, WILLIAM, LEIGH NOOK POULTRY FARM, STREET, S.O., SOMERSET. Breeder of Buff Orpingtons, Faverolles, White and Silver Wyandottes, White Leghorns. Croad Langshans of highest laying strain. Write for full particulars.

MISCELLANEOUS.

BARTER, RICHARD, ST. ANN'S HILL, CORK. Breeder Kerries and Dexters. Best milking strains. Large York Pigs, curers' type. Rent-paying Shropshire Sheep. Herds established forty years.

HONNER, MAJOR, BRANNOCKTOWN, CO. KILDARE (Railway, Harristown). Pure Shorthorn and "Dexter Shorthorns" (new breed), and Dairy Cattle. Horses: Irish Chaser and Hunter Stock, young Hunter Sires. Thoroughbreds.

MISCELLANEOUS—continued.

LARGE WHITE PIGS. Boars and Gilts eligible for Herd Book: also registered OXFORD DOWNS. Sheep and pigs are descended from prize winners. Moderate prices. J. PHIPPS SMITH, Salford Priors, Evesham.

LINCOLNSHIRE STOCK AUCTIONEERS AND AGENTS. Dickinson, Riggall and Davy, F.A.I., Agricultural Auctioneers, Valuers, and Land Agents. Speciality, Lincoln Red Short-horns, and Long-Wool Sheep, Markets and sales. Offices: Louth, Grimaby, and Brigg.

LOW, GAVIN, 50, PRUSSIA STREET, DUBLIN. Live Stock Salesman, Receiver under the Courts, &c. Pedigree and Commercial Stock bought on Commission. Store Cattle Sales every third Thursday (numbers run from 800 to 1,500 head).

PHIPPS, RICHARD, BROMYARD, WORCESTER. Hereford Pedigree Cattle. Successful exhibition Heifers, Royal Agricultural Society, 1904; Smithfield Fat Stock, 1907; also Oxford Down Sheep, commencing volume one. Inspection invited by appointment.

READ, BENJAMIN, CHURCH FARM, CAM. NEAR DURSLEY, GLOS. Dairy Shorthorns. Breeder of Dairy Show Champion and numerous other leading show winners. Sale, May, 1908. Also Herd Large Black Pigs. Telegrams and Station: "Cam" (M.R.).

ROSEHAUGH, ROSS-SHIRE. Famous herds of Aberdeen Angus and Shorthorn Cattle; select studs of Clydesdale Horses and Shetland Ponies; also Leicester Sheep. All of first-class breeding. Particulars from Thomas Henderson, Fortrose, N.B.

THOMAS, D. A., M.P., LLANWERN, NEWPORT, MON. Prize-winning herd from Stocktonbury, Hampton Court, Court House, and other leading strains. Young Bulls and Heifers by Tumbler 17588, Fine Lad 1944, and Robin Hood 21721 for sale. All eligible for the A.H.R. Also pedigree Shropshire Sheep. Inspection invited. One hour from Hereford, two and a half from London.

TOOGOOD, PARSONS, VARDON & PARSONS, MANOR VIEW, RUSTHALL, TUNBRIDGE WELLS. Breeders of Shire Horses, Guernesey Cattle, South-down Sheep, Berkshire Pigs, Aylesbury Ducks, White Orpington Fowls, and White Ferrets. Prices moderate.

# BUSCOT PARK.

**PEDIGREE SHIRES, SHORTHORNS, HAMPSHIRE  
DOWN SHEEP, BERKSHIRE PIGS. . . . .**

*The Property of SIR ALEXANDER HENDERSON, Bart.*



WANDERER'S PRINCE 78105

ADDIV to Mr. WALTER CROSLAND, Estate Office, Buscot Park, Faringdon, Berks.

## SHIRES.

STALLIONS IN SERVICE. CHAMPIONS.

### BUSCOT VICTOR.

\* Birdsall Menestrel. *d.* Lockinge  
Seabreeze.

### BUSCOT HAROLD (16576).

\* Markeaton Royal Harold (15225).  
*d.* Aurea (13951.)

### MARKEATON

#### ROYAL HAROLD (15225).

\* Harold (3703.) *d.* Sensible by  
Premier.

### PEDIGREE SHORTHORNS.

*Young Bulls, Bates-  
Cruickshank, for Sale.*

### HAMPSHIRE DOWN SHEEP.

*Sheep from this Prize-winning  
Flock have won prizes at all  
Principal Shows.*

**BRICKENDON STUD**  
 . . . OF . . .  
**SHIRE STALLIONS**

THE PROPERTY OF E. E. PEARSON, Esq.

**Cambrian Squire (21246) Foaled 1902.**

Sire - - MERE BOY (17480).  
 Dam - - CAMBRIAN GOLD (38406).

**Normoor Jameson (23556) Foaled 1904.**

Sire - - DUNSMORE JAMESON (17972).  
 Dam - - NASEBY BLACKBIRD (36717)  
 by CATTORPE IRVING (14555).

**Hitchin Thunderer II. (21519) Foaled 1902.**

Sire - - HOLKER CONQUEROR (17402).  
 Dam - - HEMSALL BLOSSOM (16772)  
 by WHAT IS WANTED (8587).

**Coleshill Forester (24149) Foaled 1905.**

Sire - - LOCKINGE FOREST KING (18867).  
 Dam - - PANSY by HERALD (11601).

**Stallions, Mares and**  
**Fillies for Sale . . .**  **INSPECTION**  
**INVITED.**

For Fees and Further Particulars:

Apply to **ESTATE OFFICE,**  
**BRICKENDONBURY,**  
**HERTFORD.**

## BORROWFIELD AND COLSTON HERDS.

The Property of R. MILLINGTON-KNOWLES, Esq., D.L., Colston Bassett Hall, Notts.



Colston Lass XIII. Winner of 1st, Champion and Gold Medal, R.A.S.E.; 1st and President's Medal, Highland; 1st Welsh National; 1st Bath and West, and numerous other 1st prizes in 1907.

### LARGE WHITE YORKSHIRES.

The following First Prizes, Championships, and Medals have been obtained in 1907 by Pigs bred in these Herds: 1st and Champion, Gold Medal, R.A.S.E. Lincoln; 1st and Champion, President's Medal, Highland, Edinburgh; 1st Welsh National, Aberystwyth; 1st Bath and West, Newport; 1st Royal Counties; 1st Nottingham; 1st Suffolk; 1st Norfolk; 1st Hereford and Worcester; Special Prize Lincoln Agricultural Society; 1st Great Yorkshire; 1st Newark; 1st Derby. A number of additional firsts, and other prizes have also been gained at the above shows.

At the St. Louis Exposition, U.S.A., in 1904, the Champion Boar and the Grand Champion of the Exposition were bred at Colston Bassett.

Inspection invited to view upwards of 200 Pigs and New Model Piggeries. A splendid selection of Boars and Gilts for Sale.

The Foreign and Home Trade has largely increased during 1907.

Breeder of Pedigree Shorthorns, Shire Horses, and Flat Coated Retrievers. A number of these always for sale.

GILBERT H. ELLIOT, Estate Office, Colston Bassett, Notts.

## THE CHILTON LODGE HAMPSHIRE DOWN FLOCK.

THE PROPERTY OF THE EXORS. OF THE LATE

Sir WILLIAM G. PEARCE, Bart., Chilton Lodge, Hungerford, Berks.



### HAMPSHIRE DOWN EWE LAMBS.

Winners of 1st and Champion at Peterborough; 1st and Reserve Champion Gloucester County; 1st Wilts County; 2nd Oxford County; 1st Royal Counties, Bournemouth; 2nd Park Royal.

Although only the second year of showing, this flock has won numerous prizes at all the leading Summer and Winter Shows, including 1st Birmingham, 1st Smithfield, and was awarded the King's Cup and the Hampshire Down Association Champion, for Best Pen of Ram Lambs at Royal Counties Show, Bournemouth.

Selections always for Sale. Free Particulars on Application to  
Mr. JAMES B. HARDING, Chilton Lodge Estate Office, HUNGERFORD.



# Sir GILBERT GREENALL, Bart.,

WALTON HALL, WARRINGTON.

## PEDIGREE HACKNEYS and HACKNEY PONIES.

This, the largest and most important stud in England of the above breeds, contains over 100 Brood Mares and some of the most celebrated Stallions of the day. Buyers for home or foreign studs will find a large number of all ages to choose from. Goldfinder VI. and Sir Horace's stock command the highest average prices of any stud in the yearly sales. The success of stock bred at this stud has been phenomenal in all the principal harness classes in the United Kingdom, and the breeding stock abroad when exhibited have won everywhere.

**Hackney Stud at Terrington, near King's Lynn, Norfolk.**  
**Ponies at Tissington, Derbyshire.**

**Sales by Auction in April and August of Hackneys and Ponies.**

## PEDIGREE HERD of KERRY CATTLE.

(OWNED BY LADY GREENALL)

This herd has won most of the principal prizes at the Royal, Bath and West, Oxfordshire, Tunbridge Wells, Royal Counties, Royal Lancashire and Dairy Shows. Holder of the Bertodano Challenge Shield for 1904 and 1905. Winner of the Milk Yield Class Royal A.S.E. 1905, 1906, and 1907, Butter Test Dairy Show 1905, and Second Milk Yield Dairy Show 1907.

Bulls, Cows, and young stock on sale.

## WALTON HERD of PEDIGREE PIGS. LARGE AND MIDDLE WHITE —YORKSHIRES.—

This Herd is unrivalled for its true type, large size and strong constitutional vigour. Its show-yard career is known all the world over, numerous prizes having been won at all the principal shows. . . . . A choice selection of Boars and Sows for sale. Inspection invited. All purchases carefully shipped.

FOR FURTHER PARTICULARS APPLY — —

**Mr. W. BAINBRIDGE, Land Agent, Walton House, WARRINGTON.**

THE RIGHT HON.

# LORD ROTHSCHILD,

TRING PARK, TRING, HERTS.

*PEDIGREE STOCK OF SHIRES, JERSEYS, RED POLLS,  
SHORTHORNS, AND HAMPSHIRE DOWN SHEEP.*

SHIRE STALLIONS:

Birdsall Menestrel (19337); Childwick Champion (22215); Blythwood Kingmaker (18534); and other well-bred Stallions of various ages.



BIRDSALL MENESTREL (19337).

THE STOCK HAVE WON PRIZES AT ALL THE LEADING SHOWS.

*For Particulars, etc., etc., please apply to*

**MR. RICHARDSON CARR,**

**ESTATE OFFICE, TRING PARK, TRING, HERTS,**

*who will be pleased to show the Stock by appointment.*

ADVERTISEMENTS.

**The Shenstone Shorthorn Herd**

The Property of  
Sir RICHARD COOPER, Bart.,  
Shenstone Court, Lichfield.

**and Shropshire Flo**

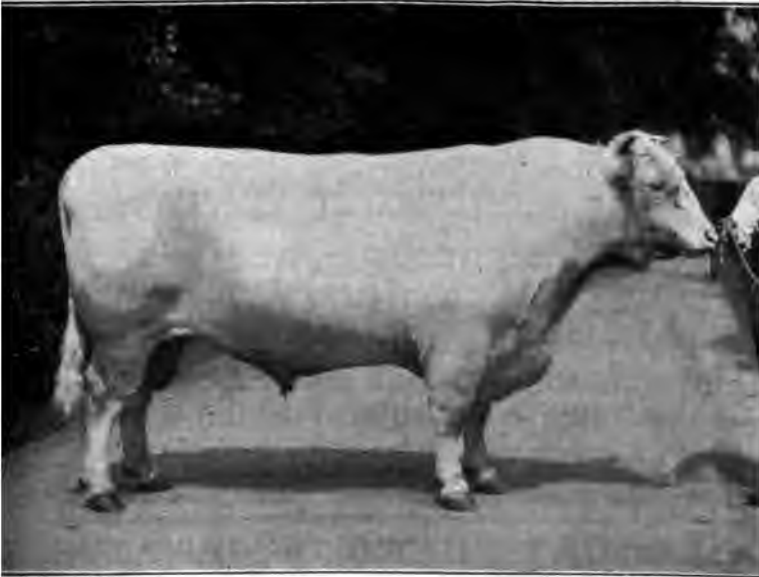

*Photo by*

*J. T. New*

**SHORTHORN BULL METEOR (86631).**

First and Champion at the Highland Society's Show, 1906, and 2nd at R.A.S.E., 1905, 1906, &



**SHENSTONE ROYAL SPECIMEN (12153).**

**SHROPSHIRE RAM. A Record Winner, 1st R.A.S.E., 1903, 1904, 1905.**

Inspected by Foreign and Colonial Buyers Invited. Pamphlet (Illustrated) of the Exp  
Pedigree Stock sent Post Free.

*The Herd of Bulls which are extensive, can be seen by appointment on application to . . .*

**FRANK WEBB, Estate Office, Shenstone, near Lich**

## **In-Foal Mares, Foals and Stallions**

FULLY INSURED AT MINIMUM PREMIUMS BY THE

# **SCOTTISH LIVE STOCK**

**INSURANCE COMPANY, LIMITED.**

Chief Offices:

**TAY STREET,  
PERTH.**

London Offices:

**9 & 10, KING STREET,  
CHEAPSIDE, E.C.,  
& 13, PALL MALL, S.W.**

The "SCOTTISH" gives the best advantages to Farmers at the lowest rates. The following are special features.—Full Market Value insured. Double Insurance on Foals.

Foals insured until the expiry of Annual Policy, or to the end of the year according to Policy, instead of for a month after birth only.

Full Compensation is paid for Foals if cast at any time before due date.

Death from risks of Accident or Disease prior to foaling insured in addition to foaling (Class B.).

Cash allowance for Barren Mares. Prompt Insurance.

## **STALLIONS INSURED AGAINST SICKNESS, ACCIDENT AND DEATH AT LOWEST RATES.**

Apply for Prospectus to the Secretary, **ARTHUR G. BULL.**

**AGENTS REQUIRED IN UNREPRESENTED DISTRICTS. LIBERAL TERMS GIVEN.**

## **"FAN COURT" HERD OF JERSEYS,**

THE PROPERTY OF **Sir E. D. STERN.**



This herd consists only of Pedigree Jerseys. It comprises animals of the finest strains, which have won numerous prizes at the various shows.

Bulls, Heifers, and Cows for Sale.

Apply to

**Sir E. D. STERN,  
"FAN COURT,"  
CHERTSEY, SURREY.**

## **THE WHARFEDALE HERD**

OF

### **MIDDLE WHITE PIGS.**

Young Boars and Gilts of the best breeding and quality for sale at moderate prices.

Amongst the numerous prizes won by this herd during 1905 were: Two first prizes and Gold Medal, Bath and West of England; two first prizes, Royal Agricultural Society of England; two first prizes Royal Lancashire Agricultural Society; one first and special, York; two firsts, special, and Championship, Leeds.

For particulars apply to the owner:—

**LEOPOLD C. PAGET, Harewood, Yorkshire.**

## **ROYAL AGRICULTURAL SOCIETY OF ENGLAND.**

Sixty-ninth ANNUAL SHOW

**Newcastle-upon-Tyne,**

**JUNE 30th to JULY 4th, 1908.**

For particulars apply to—

**THOMAS McRROW, Secretary,  
16 BEDFORD SQUARE, W.C.**

**CHARLES PERRY & CO.**

(Late Thomas Pearson & Co.),

**Midland Works, WOLVERHAMPTON.**

Established over 50 years.

**All Steel Fireproof Dutch Barns, Hay, Corn,  
Grain, and Implement Sheds.**

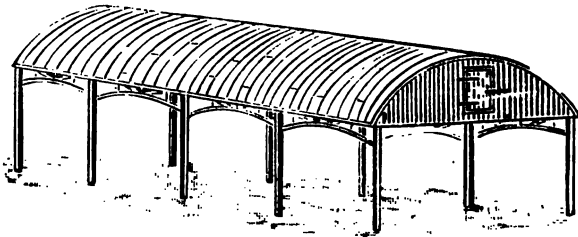

*Estimates Free on Application.*

*Special Drawings sent of Sheds to suit Purchasers' Requirements.*

IRON & WIRE FENCING, SHEEP & CATTLE HURDLES.

FEEDING APPLIANCES, &c., &c. *Send for Catalogue.*

**Genuine Anti-Corrosive Red, Maroon, &c.,**

**Oxide of Iron**

**P A I N T S**

**THE Paints for ALL outside work. ❧ ❧**

Ready mixed for use, and, what is most important,

**TREBLES THE LIFETIME of Galvanized  
Iron, Wood, Stone, and Brick work.**



Can be applied by any ordinary  
Farm hand.



Catalogue and Prices on Appli-  
cation.



**CHARLES PERRY & Co., MIDLAND WORKS,**

(Late Thomas Pearson & Co.),

**WOLVERHAMPTON.**

Established over 50 Years.

# J. & F. HOWARD, BEBFORD.

## CHAMPION PLOUGHS



S B, a very light pair-horse plough, weight 259 lbs.	£ 4 13 6
J A, the famous Cham pion, weight 200 lbs.	5 0 0
B, a pair-horse general purpose plough, weight 283 lbs.	5 15 0
Skim Coulter, 5s. 6d. extra.	
Steel instead of iron breast, 3s. extra.	

## DIGGING PLOUGHS



DDX, with two wheels, and skim coulter, weight 200 lbs.	4 5 0
LBX, with two wheels, and skim coulter, weight 236 lbs.	5 0 0
LBFX, with two wheels, and skim coulter, weight 236 lbs.	5 0 0
LBT, with steel chisel bar share, weight 236 lbs.	5 0 0

## ORIGINAL HARROWS

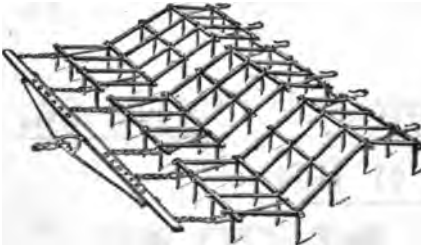

No. 14, for one or two horses, 8½ ft. wide, weight 145 lbs.	3 7 6
No. 12, for two horses, 9½ ft. wide, weight 185 lbs.	3 15 0
No. 11, for two or three horses, 10 ft. wide, weight 245 lbs.	4 5 0

## FAMOUS CULTIVATORS



No. 5, with seven tines, working width 4½ ft., weight 336 lbs.	8 0 0
Seed-box attached for broadcast sowing, Four Guinea.	
No. 7, with nine tines, working width 5½ ft., weight 366 lbs.	9 5 0
Seed-box attached for broadcast sowing, Five Guinea.	

**FIFTY SEVEN FIRST PRIZES  
AS WELL AS GOLD AND SILVER MEDALS  
HAVE BEEN AWARDED TO J. & F. HOWARD  
BY THE ROYAL AGRICULTURAL SOCIETY OF ENGLAND**

ADVERTISEMENTS

By Royal Warrant Manufacturers of Agricultural Machinery to HIS MAJESTY  
KING EDWARD VII.

# Ransomes, Sims & Jefferies

(LIMITED)



MANUFACTURE THE BEST

ROAD LOCOMOTIVES,  
TRACTION ENGINES,  
PORTABLE ENGINES,  
STATIONARY ENGINES,  
and BOILERS.



STEAM

THRASHING MACHINES,  
STRAW ELEVATORS,  
AND  
STACKERS.



**PLOUGHS**

FOR ALL PURPOSES  
AND SOILS.



**STEEL CULTIVATORS,**

IN ALL SIZES

To suit every requirement.



**SWATH TURNERS**

*For dealing quickly and efficiently  
with the Hay and Clover Crops.*

"Star" Horse Rakes,  
"Self-acting" and  
"Manual" Horse Raker  
and Hay Makers.

Illustrated Catalogues Free on application to  
**ORWELL WORKS, IPSWICH.**

*All interested in laying down land to grass  
should read*

# PERMANENT & TEMPORARY PASTURES.

By MARTIN J. SUTTON, F.L.S.

*The Times* says:—

"The general arrangement of the volume is the same as heretofore, and the book remains, and is likely to long continue to be, our standard authority upon the cultivation of grass land."

*The Journal of the Royal Agricultural Society* says:—

"A practical book written by a practical man for practical men."

*The Field* says:—

"Mr. M. J. Sutton's valuable book, which, since it was first published some fifteen years ago, has rightly been regarded as the standard work on the subject of grass lands, requires no introduction at this time of day; but, well known as the volume is, the information that a sixth edition has been called for and supplied will be received with interest and satisfaction."

**Sixth Edition.** Price 6s., bound in cloth.

Completely revised, and containing a chapter on Weeds found in Pastures. An Index has also been added. Substantially bound in cloth. Illustrated with 28 varieties of Natural Grasses, Clovers, &c., and containing 46 Analyses of Grasses, Clovers, &c., prepared expressly for this work by Dr. J. Augustus Voelcker.

**Edition de Luxe.** Price 51s., bound in cloth, bevelled boards. Containing the original coloured plates.

---

## SUTTON'S

### Farmers' Year-Book and Graziers' Manual.

This work contains descriptions, illustrations, and much valuable information on the best varieties of grasses and clovers.

Published annually in February. Post free on application from

**SUTTON & SONS, READING.**





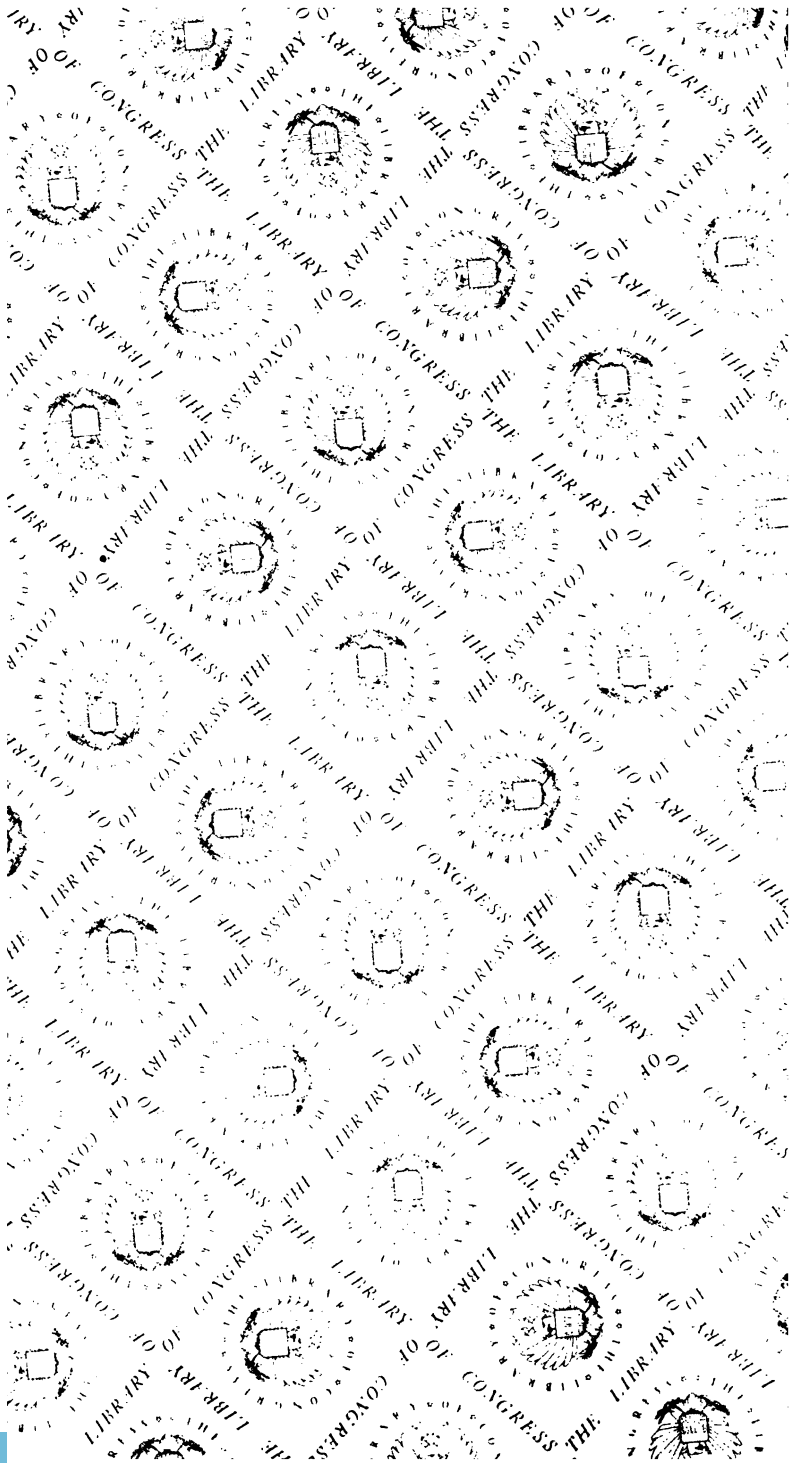

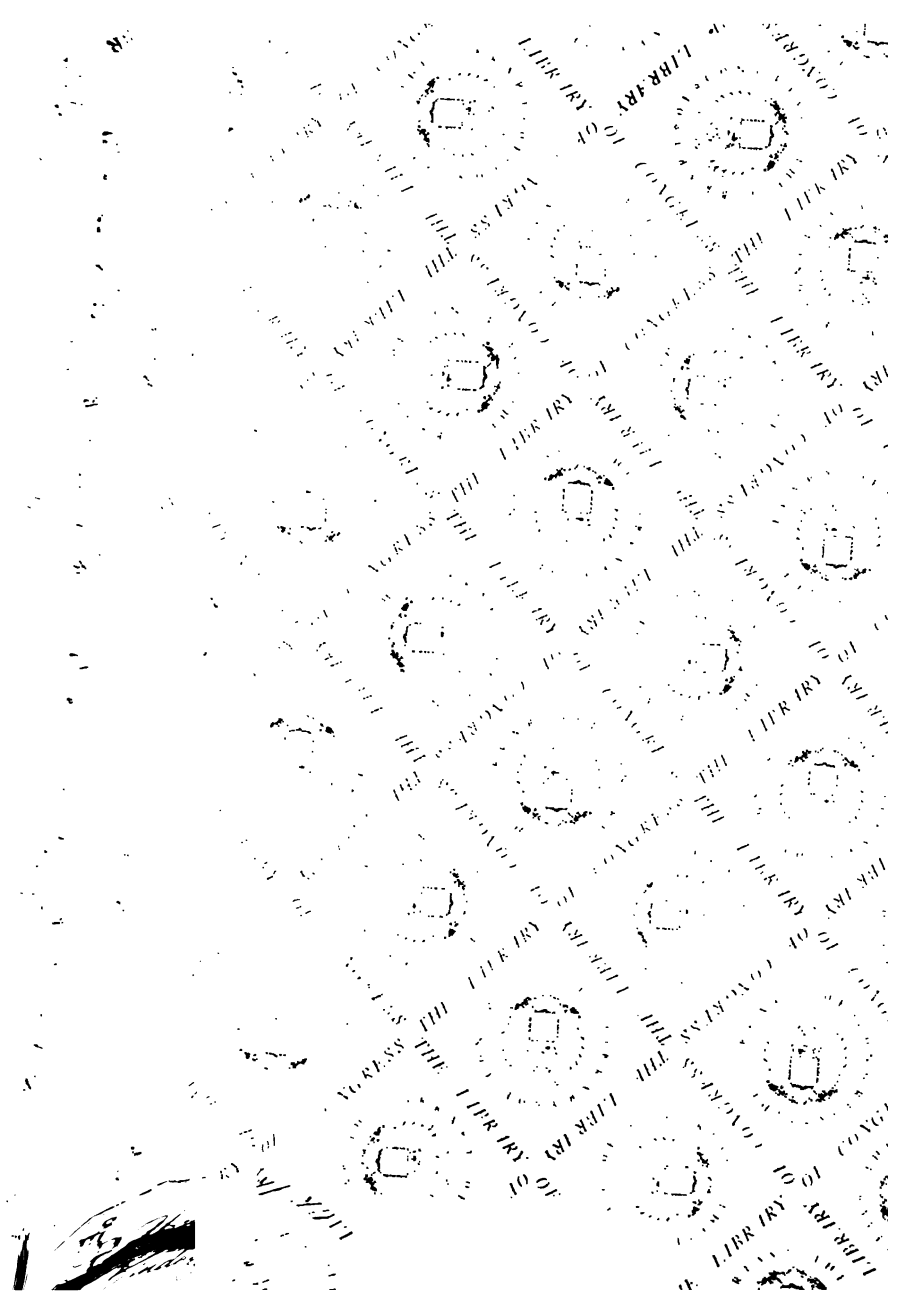

LIBRARY OF CONGRESS



00026917141